

Positive Input Ventilation Systems

Whole House Ventilation Unit



The Benefits of 'Input' Ventilation

for your home, health & lifestyle

What is PIV?

Positive Input Ventilation

It is a concept to deliver fresh filtered air into a property at a continuous rate.

Did you know...

Hundreds of thousands of homes across the UK are benefiting from having a PIV unit installed?

It is the second most popular method of ventilating homes after intermittent extract fans?

The reason is...

In addition to the 112 pints of moisture that an average family produces per week through cooking, bathing, ironing and breathing, a concoction of other contaminants is present in the air within our homes.

These can have a detrimental effect on the fabric of our homes and the health of our families. With improved building features in our homes, such as cavity wall insulation, double glazing and draught proofing, 'natural ventilation' is severely restricted. Stale, contaminated air is trapped causing streaming windows, which ultimately leads to musty smells, dampness and mould growth.

The solution to reducing condensation, mould and indoor contaminants



Mould

Mould spores account for a significant amount of household dust



Dust Mites

You are sharing your bed with thousands of them!



Smoke

5-10% of all lung cancer is linked directly to passive smoking



Radon

Studies have linked exposure to Radon to increased risk of lung cancer



VOC's

Can lead to irritation and headaches as well as risk of neurotoxic effects

The Solution - Say goodbye to condensation and mould for good!

The solution is Positive Input Ventilation (PIV). EnviroVent's positive ventilation units are energy efficient condensation-control units. By drawing in fresh, filtered and clean air from outside, the units gently ventilate the home from a central position on a landing in a house or the central hallway in a flat or bungalow. Moisture laden air is diluted, displaced and replaced to control humidity levels between 45-60%*.

This significantly reduces or eliminates surface condensation, the main cause for mould growth. With lower humidity levels, dust mite populations are also substantially reduced to provide a significant improvement in the health of asthma sufferers and general indoor air quality. Positive Input Ventilation is also available for flats and apartments. **Turn to pages 09 and 10 for further information.**

Phase One

Shortly after the unit is installed the unit gently ventilates the home with fresh air. Air is pushed back down into the house and redistributed. Humidity is diluted and replaced to leave a healthy, fresh and clean environment to live in.



Phase Two

House is now free from contaminants, the unit transforms a stagnant, stale atmosphere into a fresh, healthy and condensation free environment.



PIV

Loft Mounted Unit

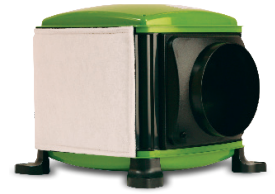

Whole House Positive Input Ventilation



About

The EnviroVent Loft Mounted Unit is a sophisticated whole home ventilation and condensation control unit for homes with a loft space. The unit gently ventilates the home from a central position on the landing in a house or the central hallway in a bungalow to transform a stagnant and stale atmosphere into a fresh, healthy and condensation free environment.

Features & Benefits

- Superior long life filters
- Ultra Low Watt DC motor technology
- Integral Hours Run Meter (as standard)
- Integral intelligent comfort heater (as standard)
- 5 year guarantee
- Reduces/eliminates surface condensation
- Quiet operation
- Eliminates mould
- Stops streaming windows
- Removes musty odours
- Improves air quality
- Enhances heat distribution
- Takes advantage of the benefits of solar gain
- Benefits asthma sufferers
- Expert fitting staff

Energy Saving Benefits

✔ Minimum Energy Consumption

Powered by an Ultra Low Watt Brushless DC Motor, the PIV EnviroVent Loft Mounted Unit utilises the latest technology to ensure minimum energy consumption and long term trouble free life.

✔ Solar Gain

The unit takes maximum advantage of the benefits of solar gain from within the loft space - the natural accumulation of heat from the sun on bright days.

Temperatures in the loft space are on average 3°C higher than outside, which results in a relative saving of around 150 Watts per day in an average modern family home. This equates to approximately 10% of annual heating costs.

✔ Heat Distribution

Warm air accumulates at ceiling level. This air can be up to 7°C higher than the internal air at ground level. By introducing an almost imperceptible air supply into the dwelling from the loft space, the EnviroVent PIV Loft Mounted Unit helps to redistribute heat around the home and thus reduce space heating costs.

✔ No Need to Open Windows

Powered by an Ultra Low Watt Brushless DC Motor, the PIV EnviroVent Loft Mounted Unit utilises the latest technology to ensure minimum energy consumption and long term trouble free life.



Health Benefits

With improved building features in our homes, such as cavity wall insulation, double glazing and draught proofing, 'natural ventilation' is prohibited. Stale air is trapped causing streaming windows, which ultimately leads to musty smells, dampness and mould growth. These mould spores are known allergens and become airborne at the slightest disturbance.

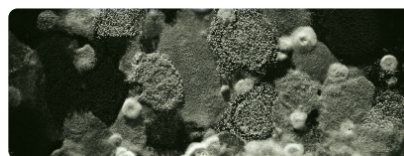

The microscopic spores are then inhaled and can trigger respiratory problems such as asthma, dust allergies and hayfever. The EnviroVent Loft Mounted Unit draws fresh air into the dwelling from outside and filters it before being delivered into the property. Moisture-laden air is diluted, displaced and replaced with clean, tempered and filtered air. This eliminates or reduces surface condensation, which causes mould growth, providing a significant improvement in the health of asthma sufferers and general indoor air quality.



✓ Low Life-cycle Costs

With 5 year on-going maintenance free warranties and superior long life filters the unit achieves the lowest life-cycle costing. All repairs, maintenance and component replacement is carried out simply and quickly by exchanging the filters and consumable items. The worn out components are then taken back to the factory to be recycled thus reducing the impact on landfill and saving millions of pounds in replacement costs.

✓ Pre-Heater and Hours Run Meter

The integral pre-heater is designed to temper the incoming air during periods of low external temperatures. A sensor monitors incoming air and slowly pulses the heater to ensure temperatures are held to pre-set minimums. Two independent safety cut-out devices shut down the heater in the event of fan failure. The heater facility is controlled independently from the fan by a conveniently positioned enable/disable switch. For monitoring of operational life and verification of usage, an integral Hours Run Meter is fitted.

Upgrade to PIV Air Source



Beyond traditional input ventilation, the PIV Air Source has the facility to source cooler air from outside the building when the temperature in the loft space rises above 25°C. Detecting the rise in temperature, the unit starts to draw air from atmosphere via a temperature controlled diverter mechanism. This not only provides efficient perception cooling into the property during warmer weather, but also maintains the required level of ventilation continuously throughout the year. This facility is greatly beneficial for properties affected by high levels of Radon.



Intelligent Remote Control (optional)

A remote control incorporating five mode settings: trickle, medium, high, boost and auto is available. Auto-mode enables or disables the heater.



Annual Running Costs

Annual running costs with heater **DISABLED**. All costs are based on an electricity cost of **£0.15 per unit (kWh)**. The calculations must therefore be used as a guide only.

Settings

PIV Loft Mounted Unit

TRICKLE	MEDIUM
£4.86	£5.85

The PIV Air Source Unit has been calculated at 320 days supplying air through the filter and 45 days sourcing directly from outside taken from average annual temperatures.

PIV Air Source

TRICKLE	MEDIUM
£4.41	£5.70

Comparisons against other household appliances

PIV Loft Mounted Unit

HOUSEHOLD APPLIANCE	TIME REQUIRED TO CONSUME £5.85 OF ELECTRICITY
FRIDGE FREEZER	20 DAYS
42" TV (VIEWING TIME)	20 DAYS
100W LIGHT BULB	14.6 DAYS
HOME PC	4.7 DAYS
GAMES CONSOLE	4.7 DAYS
IRON	41 HOURS
TUMBLE DRYER	17 HOURS
COLDFILL DISHWASHER	17 LOADS

PIV Air Source

HOUSEHOLD APPLIANCE	TIME REQUIRED TO CONSUME £5.70 OF ELECTRICITY
FRIDGE FREEZER	19.7 DAYS
42" TV (VIEWING TIME)	19.6 DAYS
100W LIGHT BULB	14.3 DAYS
HOME PC	4.6 DAYS
GAMES CONSOLE	4.6 DAYS
IRON	41 HOURS
TUMBLE DRYER	17 HOURS
COLDFILL DISHWASHER	17 LOADS

Options & Ancillaries

ENVIROVENT DIFFUSER	1DIF EVL DIF
FLEXIBLE HOSE DUCTING - Ø200	1RD FLEX 200 X 1M 1RD FLEX 200 X 3M 1RD FLEX 200 X 6M

Dimensions (mm)

PIV Loft Mounted Unit

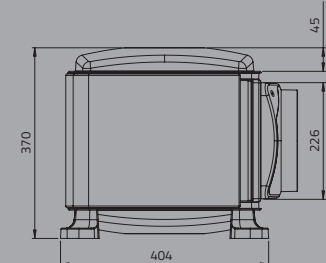
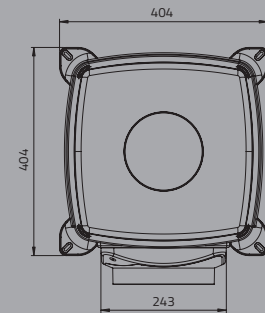
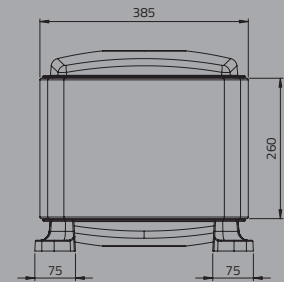
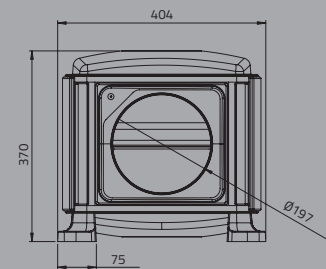

Dimensions (mm)

PIV Air Source

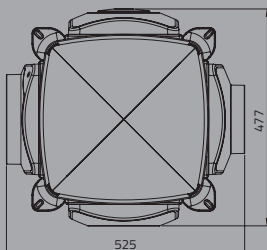
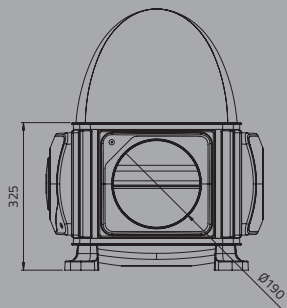
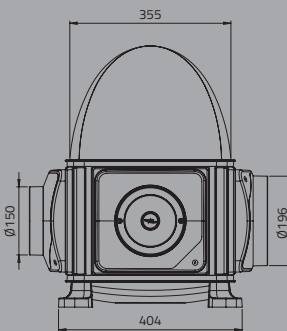
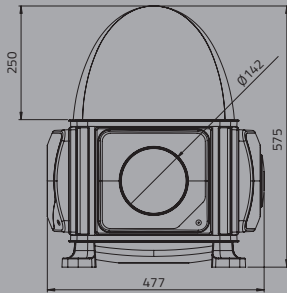

Technical Specification

Applications

PIV Loft Mounted Unit

Sited in a loft space, the unit delivers air to the central hallway or landing via a four-way diffuser with purpose made blanking plates to maximise efficiency of airflow and aid in heat recovery from ceiling level. This provides displacement ventilation in order to improve air quality and resolve condensation related problems.

PIV Air Source

The PIV Air Source Unit has the additional facility to draw air from atmosphere during the warmer months of the year when the temperature in the loft space exceeds 25°C. This provides efficient perception cooling into the property and maintains the required level of ventilation continuously throughout the year.

Performance & Sound Levels (as installed)

PIV Loft Mounted Unit

Incoming Air Temp. [°C]	Fan Speed Setting	Specific Fan Power (SFP)	Airflow [l/s]	Power Usage [W] (4)	Outlet Noise dB(A) @3m
<19 (1) (2)	Trickle	0.14	22	3	<15
	Medium	0.14	29	4	<15
	Large	0.15	35	5	<15
	Boost	0.18	43	8	15

Remote control versions (EVL-W and EVL-H-W) achieve 58 l/s at boost

PIV Air Source

Incoming Air Temp. [°C]	Fan Speed Setting	Specific Fan Power (SFP)	Airflow [l/s]	Power Usage [W] (4)	Outlet Noise dB(A) @3m
<19 (1) (2)	Trickle	0.14	22	3	<15
	Medium	0.14	29	4	<15
	Large	0.15	35	5	<15
	Boost	0.18	43	8	15
<25 (3)	Trickle	0.28	28	7.9	-
	Medium	0.26	35	9.2	-
	Large	0.25	44	10.9	-
	Boost	0.27	52	14	-

- The unit performs in 'condensation control mode' at air temperatures below 19°C
- At above 19°C the unit increases airflow rates per setting by 10%
- The unit performs in 'summer by-pass mode' at air temperatures at or above 25°C
- Power usage with heater disabled

Construction

ABS plastic to contain at least 50% recycled material.

Motor

Incorporates the Ultra Low Watt DC motor technology with sealed for life ball bearings designed to operate continuously at a pre-set 'background' rate.

Fan

Is a 140 x 220mm centre mounted forward curved centrifugal fan.

Filter

Is a synthetic fibre based filter mat to G4 standard in accordance with EN779 standard ratings, conforming to all European Union and US fire classification standards (e.g. DIN 53438-F1 and UL900-class 2) and be self-extinguishing.

Servicing/Maintenance

Achieved by exchanging filters and consumable items. There should be no requirement for any maintenance within the five year period.

Integral 'Intelligent Low Temperature' Comfort Heater

Powered by a single supply and capable of holding incoming air temperatures accurately – around 10°C. The integral heater element is manufactured in a solid tubular sheath material and not in open wire format.

Accreditations

This product is in conformity with the European Low Voltage Directive 2006/95/EEC and the EMC Directive 2004/108/EC including amendments. Full compliance with the relevant parts of the standards listed below supports the conformity of the designated product with the provisions of the above mentioned EC Directives.

Low Voltage Directive

EN 60335-1:2002, +A1:2004, +A11:2004, +A2:2006, +A12:2006, +A13:2008, +A14:2010
EN 60335-2-80:2003, +A1:2004, +A2:2009

EMC Directive

EN55014-1:2006 (EMISSIONS)
EN55014-2:1997, +A1:2001 Cat IV (IMMUNITY)

Performance Curves

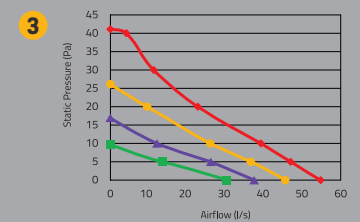
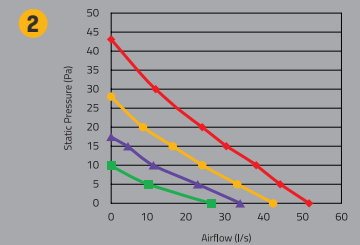
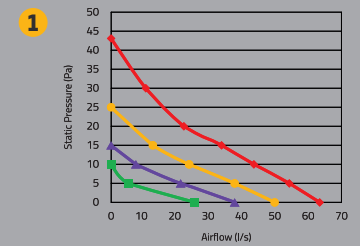

- 1 PIV Loft Mounted Unit
- 2 PIV Air Source with summer by-pass NOT activated
- 3 PIV Air Source with summer by-pass activated
- Trickle
- Medium
- Large
- Boost

Performance curve results are based on the unit running below 19°C and exclude ancillaries

MIV®

Loft Mounted Unit

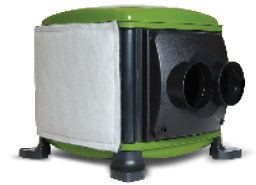

Multiple Input Ventilation (MIV®)



About

Building on the principles of the hugely successful and established EnviroVent PIV systems, the MIV® Loft Mounted Unit has been designed and developed to launch a totally new and innovative technology - Multiple Input Ventilation (MIV®).

Features & Benefits

- ▶ Ultra Low Watt DC motor technology
- ▶ Sealed for life ball bearings
- ▶ Loft or external air supply
- ▶ Integral Hours Run Meter (as standard)
- ▶ Integral intelligent comfort heater (as standard)
- ▶ Optional remote controlled boost facility
- ▶ 5 year on-going maintenance free warranties
- ▶ Provides all year round quality filtered air
- ▶ Reduces/eliminates surface condensation
- ▶ Quiet operation
- ▶ Removes musty odours
- ▶ Enhances heat distribution
- ▶ Takes advantage of the benefits of solar gain in the loft space
- ▶ Benefits asthma sufferers by reducing dust mites and mould spores
- ▶ Reduces Radon levels

How is it Different?

Instead of providing just a single source of fresh air into a property, usually located in a hallway or landing, the MIV® Loft Mounted Unit has the ability to supply fresh, filtered air via multiple inputs into areas with greater requirements for ventilation.

Highly efficient, inputs can be situated into or adjacent to rooms affected by increased levels of humidity, such as the kitchen, bathrooms and other wet rooms.

Fresh air inputs can also be located in bedrooms or living spaces that suffer from particularly bad condensation or in the bedroom of an asthma sufferer to reduce the level of humidity and therefore the house dust mite population – a known trigger for allergies and asthma.



Unique EnviroVent Mini Diffuser

Available with the MIV® Loft Mounted Unit is the stylish EnviroVent energy saving diffuser, providing an innovative alternative to standard ceiling vents.



Make it MIV® Multi-Zone Destratification

Warm air accumulates at ceiling level and is normally lost through windows and extract fans. This air can be up to 7°C higher than the internal air at ground level.

By introducing an almost imperceptible fresh air supply into multiple rooms, the MIV® Loft Mounted Unit redistributes heat around the home by pushing the heat back down and keeping the convection currents moving to reduce space heating costs. By saving only 1 degree of heat this multi-zone destratification can cut fuel bills by 10%.

Energy Saving Benefits

✔ Minimum Energy Consumption

Powered by an Ultra Low Watt Brushless DC Motor, the MIV® Loft Mounted Unit utilises the latest technology to ensure minimum energy consumption and long term trouble free life.

✔ Solar Gain

The unit takes maximum advantage of the benefits of solar gain from within the loft space - the natural accumulation of heat from the sun on bright days. Temperatures in the loft space are on average 3°C higher than outside, which results in a relative saving of around 150 Watts per day in an average modern family home. This equates to approximately 10% of annual heating costs.

✔ Heat Distribution

Warm air accumulates at ceiling level. This air can be up to 7°C higher than the internal air at ground level. By introducing an almost imperceptible air supply into the dwelling from the loft space, the MIV® Loft Mounted Unit helps to redistribute heat around the home and thus reduce space heating costs.

✔ No Need to Open Windows

To reduce humidity and condensation during the heating season, significant energy loss occurs by opening windows. By installing an MIV® Loft Mounted Unit and providing fresh filtered air to the home humid air is displaced without opening windows and thus making significant savings to the occupier.



Upgrade to MIV® Air Source



Solar Gain & Summer Cooling

Air Source takes maximum advantage of the benefits of solar gain from the loft space throughout the year. Solar gain is the natural accumulation of heat from the sun on bright days.

Temperatures in the loft are on average 3°C higher than outside and as the unit draws fresh air from the loft and delivers it into the property, this results in a saving of around 500 Kilowatts of energy per year in an average family home – equating to significant savings in annual heating costs. Going beyond traditional input ventilation, the MIV® Air Source has the facility to source cooler air from outside the building when the temperature in the loft space rises above 25°C.

Detecting the rise in temperature, the unit starts to draw air from atmosphere via a temperature controlled diverter mechanism. This not only provides efficient perception cooling into the property during warmer weather, but also maintains the required level of ventilation continuously throughout the year. This facility is greatly beneficial for properties affected by high levels of Radon.



Intelligent Remote Control (optional)

A remote control incorporating five mode settings: trickle, medium, high, boost and auto is available. Auto-mode enables or disables the heater.



Annual Running Costs

Annual running costs with heater DISABLED. All costs are based on an electricity cost of £0.15 per unit (kWh). The calculations must therefore be used as a guide only.

Settings

MIV® Loft Mounted Unit

TRICKLE	MEDIUM
£4.86	£5.85

The MIV® Air Source Unit has been calculated at 320 days supplying air through the filter and 45 days sourcing directly from outside taken from average annual temperatures.

MIV® Air Source

TRICKLE	MEDIUM
£4.30	£5.71

Comparisons against other household appliances

MIV® Loft Mounted Unit

HOUSEHOLD APPLIANCE	TIME REQUIRED TO CONSUME £5.85 OF ELECTRICITY
FRIDGE FREEZER	20 DAYS
42" TV (VIEWING TIME)	20 DAYS
100W LIGHT BULB	14.6 DAYS
HOME PC	4.7 DAYS
GAMES CONSOLE	4.7 DAYS
IRON	41 HOURS
TUMBLE DRYER	17 HOURS
COLDFILL DISHWASHER	17 LOADS

MIV® Air Source

HOUSEHOLD APPLIANCE	TIME REQUIRED TO CONSUME £5.70 OF ELECTRICITY
FRIDGE FREEZER	19.7 DAYS
42" TV (VIEWING TIME)	19.6 DAYS
100W LIGHT BULB	14.3 DAYS
HOME PC	4.6 DAYS
GAMES CONSOLE	4.6 DAYS
IRON	41 HOURS
TUMBLE DRYER	17 HOURS
COLDFILL DISHWASHER	17 LOADS

Options & Ancillaries

ENVIROVENT MINI DIFFUSER	1DIF EVL SML1
ROUND RIGID DUCTING - Ø100	1RD 100 X 2M
90° BEND - Ø100	1RD 90 BEND 100

Dimensions (mm)

MIV® Loft Mounted Unit

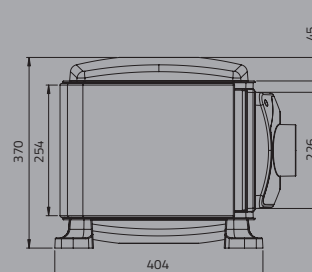
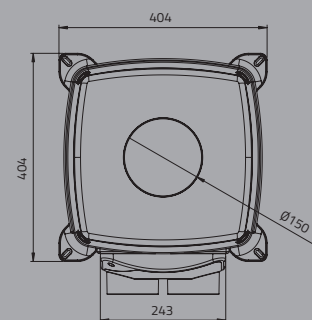
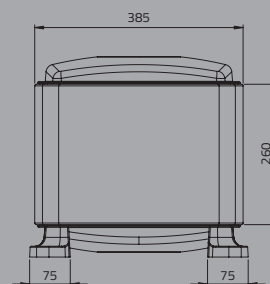
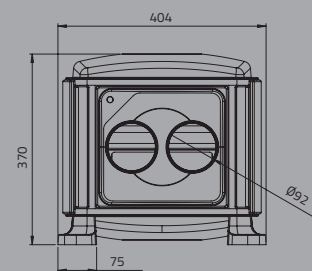

Dimensions (mm)

MIV® Air Source

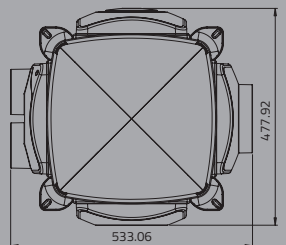
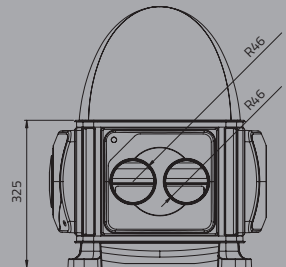
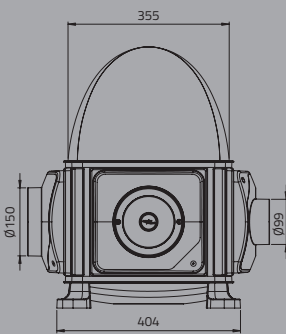
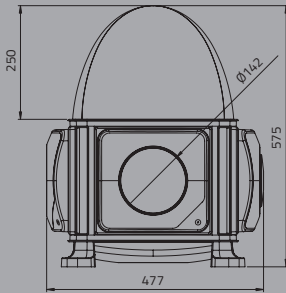

Technical Specification

Applications

MIV® Loft Mounted Unit

Sited in a loft space, the unit delivers air to multiple rooms of a property to provide displacement ventilation in order to improve indoor air quality and resolve condensation related problems.

MIV® Air Source

During warmer months of the year when the temperature in the loft space exceeds 25°C, the MIV® Air Source has the additional facility to draw air from atmosphere via a temperature controlled diverter mechanism. This provides efficient perception cooling into the property and maintains the required level of ventilation continuously throughout the year.

Performance & Sound Levels (as installed)

MIV® Loft Mounted Unit

Incoming Air Temp. [°C]	Fan Speed Setting	Specific Fan Power (SFP)	Airflow [l/s]	Power Usage [W] [3]	Outlet Noise dB(A) @3m
<19 (1) (2)	Trickle	0.24	15	4	<15
	Medium	0.22	20	4	<15
	Large	0.21	26	6	<15
	Boost	0.25	34	9	<15

MIV® Air Source

Incoming Air Temp. [°C]	Fan Speed Setting	Specific Fan Power (SFP)	Airflow [l/s]	Power Usage [W] [3]	Outlet Noise dB(A) @3m
<19 (1) (2)	Trickle	0.16	22	3	<15
	Medium	0.18	29	4	<15
	Large	0.23	35	5	<15
	Boost	0.31	43	8	15
>25 (3)	Trickle	0.28	26	7.3	-
	Medium	0.31	32	9.8	-
	Large	0.33	38	12.6	-
	Boost	0.36	44	15.7	-

- The unit performs in 'condensation control mode' at air temperatures below 19°C
- At above 19°C the unit increases airflow rates per setting by 10%
- The unit performs in 'summer by-pass mode' at air temperatures at or above 25°C
- Power usage with heater disabled

Construction

ABS plastic to contain at least 50% recycled material.

Motor

Incorporates the Ultra Low Watt DC motor technology with sealed for life ball bearings designed to operate continuously at a pre-set 'background' rate.

Fan

Is a 140 x 220mm centre mounted forward curved centrifugal fan.

Filter

Is a synthetic fibre based filter mat to G4 standard in accordance with EN779 standard ratings. The filter should conform to all European Union and US fire classification standards (e.g. DIN 53438-F1 and UL900-class 2) and be self-extinguishing.

Servicing/Maintenance

Achieved by exchanging filters and consumable items. There should be no requirement for any maintenance within the five year period.

Integral 'Intelligent Low Temperature' Comfort Heater

Powered by a single supply and capable of holding incoming air temperatures accurately – around 10°C. The integral heater element is manufactured in a solid tubular sheath material and not in open wire format.

Accreditations

This product is in conformity with the European Low Voltage Directive 2006/95/EEC and the EMC Directive 2004/108/EC including amendments. Full compliance with the relevant parts of the standards listed below supports the conformity of the designated product with the provisions of the above mentioned EC Directives.

Low Voltage Directive

EN 60335-1:2002, +A1:2004, +A11:2004, + A2:2006, +A12:2006, +A13:2008, +A14:2010
EN 60335-2-80:2003, +A1:2004, +A2:2009

EMC Directive

EN55014-1:2006 (EMISSIONS)
EN55014-2:1997, +A1:2001 Cat IV (IMMUNITY)

Performance Curves

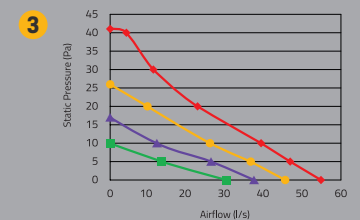
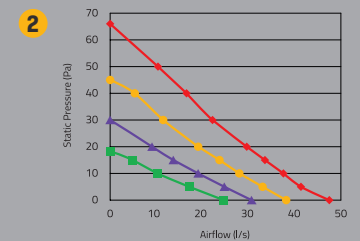
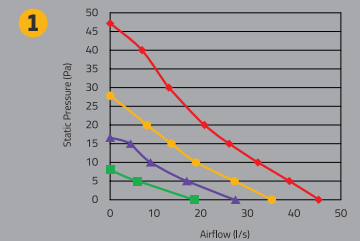

- 1 MIV® Loft Mounted Unit
- 2 MIV® Air Source with summer by-pass NOT activated
- 3 MIV® Air Source with summer by-pass activated
- Trickle
- Medium
- Large
- Boost

Performance curve results are based on the unit running below 19°C and exclude ancillaries

Wall Mounted Unit

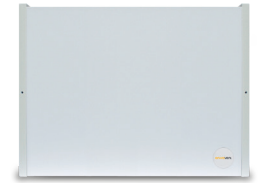

Whole House Positive Input Ventilation Unit For Flats



About

The EnviroVent Wall Mounted Unit is designed to provide whole home ventilation and eradicate condensation from homes without a loft space. Energy efficient, the unit introduces an almost imperceptible air supply throughout the living space to transform a stagnant and stale atmosphere into a fresh, healthy and condensation free environment.

Features & Benefits

- Ultra Low Watt DC motor technology
- Integral Hours Run Meter (as standard)
- Integral Pre-Heater (as standard)
- 5 year guarantee
- Reduces/eliminates surface condensation
- Quiet operation
- Eliminates mould
- Stops streaming windows
- Removes musty odours
- Improves air quality
- Enhances heat distribution
- Benefits asthma sufferers
- Expert fitting staff

Energy Saving Benefits

✔ Minimum Energy Consumption

Powered by an Ultra Low Watt Brushless Motor, the EnviroVent Wall Mounted Unit utilises the latest technology to ensure minimum energy consumption and long term trouble free life.

✔ Heat Distribution

Warm air accumulates at ceiling level. This air can be up to 7°C higher than the internal air at ground level. By introducing an almost imperceptible air supply into the dwelling, the EnviroVent Wall Mounted Unit helps to redistribute heat around the home and thus reduce space heating costs.

✔ No Need to Open Windows

To reduce humidity and condensation during the heating season, significant energy loss occurs by opening windows. By installing an EnviroVent Wall Mounted Unit and providing fresh filtered air into the home, humid air is displaced without the need to open any windows, thus making significant savings to the occupier.

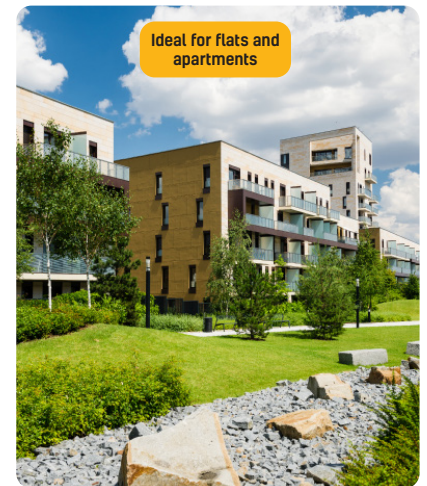

Health Benefits

With improved building features in our homes, such as cavity wall insulation, double glazing and draught proofing, 'natural ventilation' is prohibited. Stale air is trapped causing streaming windows, which ultimately leads to musty smells, dampness and mould growth. These mould spores are known allergens and become airborne at the slightest disturbance.

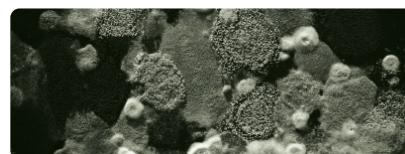

The microscopic spores are then inhaled and can trigger respiratory problems such as asthma, dust allergies and hayfever. The EnviroVent Wall Mounted Unit draws fresh air into the dwelling from outside and filters it before being delivered into the property. Moisture-laden air is diluted, displaced and replaced with clean, tempered and filtered air. This eliminates or reduces surface condensation, which causes mould growth, providing a significant improvement in the health of asthma sufferers and general indoor air quality.



More Energy Saving Benefits

✓ Low Life-cycle Costs

With 5 year on-going warranties and superior long life filters the unit achieves the lowest life-cycle costings. All other component replacement is carried out simply and quickly by exchanging the consumable items. The worn out components are then taken back to the factory to be recycled thus reducing the impact on landfill and saving millions of pounds in replacement costs.



✓ Pre-Heater and Hours Run Meter

The integral pre-heater is designed to temper the incoming air during periods of low external temperatures. A sensor monitors incoming air and pulses the heater to ensure temperatures are held to pre-set minimums. Two independent safety cut-out devices shut down the heater in the event of fan failure. The heater facility is controlled independently from the fan by a conveniently positioned enable/disable switch. For monitoring of operational life and verification of usage, an integral Hours Run Meter is fitted.

Dimensions (mm)

Wall Unit

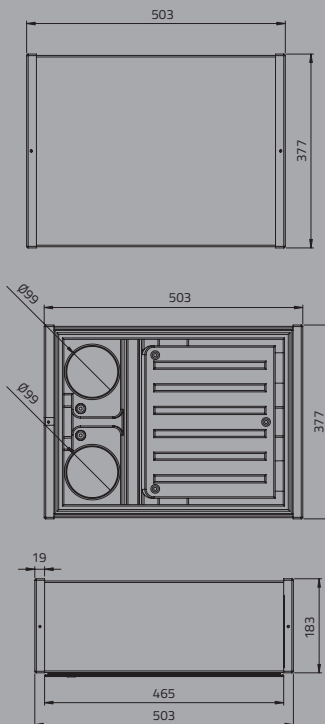

Technical Specification

Applications

Sited on a suitable wall, the EnviroVent Wall Mounted Unit delivers air to the central hallway to provide displacement ventilation in order to improve air quality and resolve condensation related problems.

Performance & Sound Levels (as installed)

Incoming Air Temp. (°C)	Fan Speed Setting	Specific Fan Power (SFP)	Airflow (l/s)	Power Usage (W)	Outlet Noise dB(A) @3m
<19 ⁽¹⁾	Trickle	0.39	9	3.4	<15
	Medium	0.33	11	3.8	<15
	Large	0.29	12	4.8	17
	Boost	0.30	20	6.1	20.3
>19 ⁽²⁾	Trickle	0.37	10	3.6	-
	Medium	0.33	14	4.4	-
	Large	0.29	19	5.4	-
	Boost	0.32	23	7.4	-

- The unit performs in 'condensation control mode' at air temperatures below 19°C
- At above 19°C the unit increases airflow rates per setting by 10%

Motor

Incorporates the Ultra Low Watt DC motor technology with sealed for life ball bearings designed to operate continuously at a pre-set 'background' rate.

Fan

Is a 140 x 220mm centre mounted forward curved centrifugal fan.

Filter

Is fitted with an integral insect filter.

Servicing/Maintenance

Achieved by removal/exchange/replacement of filters and consumable items. There should be a filter exchange after 24-36 months.

Integral 'Intelligent Low Temperature' Comfort Heater

Powered by a single supply and capable of holding incoming air temperatures accurately – around 10°C. The integral heater element is manufactured in a solid tubular sheath material and not in open wire format.

Accreditations

This product is in conformity with the European Low Voltage Directive 2006/95/EEC and the EMC Directive 2004/108/EC including amendments. Full compliance with the relevant parts of the standards listed below supports the conformity of the designated product with the provisions of the above mentioned EC Directives.

Low Voltage Directive

EN 60335-1:2002, +A1:2004, +A11:2004, + A2:2006, +A12:2006, +A13:2008, +A14:2010
EN 60335-2-80:2003, +A1:2004, +A2:2009

EMC Directive

EN55014-1:2006 (EMISSIONS)
EN55014-2:1997, +A1:2001 Cat IV (IMMUNITY)



Annual Running Costs

Annual running costs with heater DISABLED. All costs are based on an electricity cost of £0.15 per unit (kWh). The calculations must therefore be used as a guide only.

Settings

TRICKLE	MEDIUM
£4.47	£5.00

HOUSEHOLD APPLIANCE	TIME REQUIRED TO CONSUME £5.00 OF ELECTRICITY
FRIDGE FREEZER	17 DAYS
42" TV (VIEWING TIME)	17 DAYS
100W LIGHT BULB	12.5 DAYS
HOME PC	4 DAYS
GAMES CONSOLE	4 DAYS
IRON	41 HOURS
TUMBLE DRYER	17 HOURS
COLD FILL DISHWASHER	15 LOADS

Performance Curves

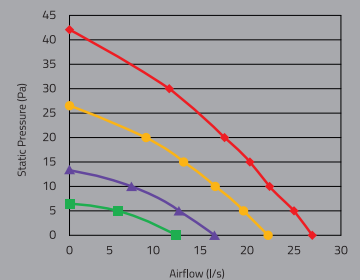

Performance curve results are based on the unit running below 19°C and exclude ancillaries

- Trickle
- Medium
- Large
- Boost



Find us on Facebook



Follow us on Twitter



Watch us on Youtube

envirovent®

Leaders in the manufacture of innovative and sustainable ventilation

EnviroVent Ltd	T / 01423 810 810
EnviroVent House	F / 01423 301 022
Hornbeam Business Park	E / info@envirovent.com
Harrogate	
HG2 8PA	W / www.envirovent.com

Due to our policy of continuous innovation and improvement, EnviroVent reserves the right to alter products specification and appearance without notice.

E&OE | MKT ENV203 - V11 - 22.07.21

Copyright © EnviroVent Ltd 2021

