



CAB

5113862300 - CAB-100 (230V 50/60) R8 - ACOUSTIC CABINET FANS



Centrifugal fan cabinet with manufactured from galvanised sheet steel, acoustic and fire retardant lining 50 mm thick. Forward curved centrifugal fan with closed single-phase motor and speed controllable. IP44, B Brand S&P model CAB-100 (230V 50/60) R8 for an airflow 192 m³/h and static pressure 1,44 Pa.

Theoretical Working Point

Airflow	194 m ³ /h
Static Pressure	1,47 Pa
Temperature	20 °C
Altitude	0 m
Density	1,2 kg/m ³
Frequency	50 Hz

Working Point

Airflow	192 m ³ /h
Static Pressure	1,44 Pa
Dynamic pressure	27,9 Pa
Total Pressure	29,3 Pa
Input power	0,042 kW
Outlet speed	6,8 m/s
Fan speed	1398 rpm
Specific Fan Power	0,79 W/l/s

Construction

Discharge diameter	100 mm
Fan size	140/059
Weight	16,00 kg

Motor Characteristics

Number of poles	4
Voltage	1-230V-50Hz
Maximum absorbed current	0,2 A
IP Rating	IP44
Motor insulation class	B

Drawing

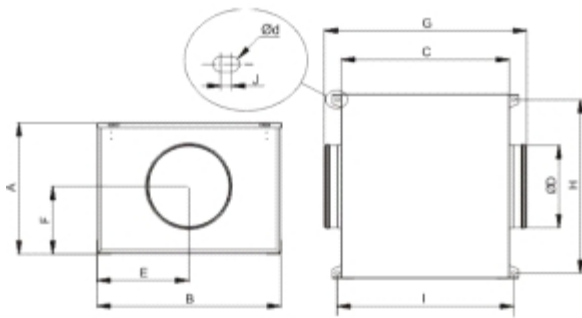

A	B	C	D	E	F	G	H	I
273	388	395	100	125	162	505	355	424
J	Ød							
6.5	4.5							

Performance Chart

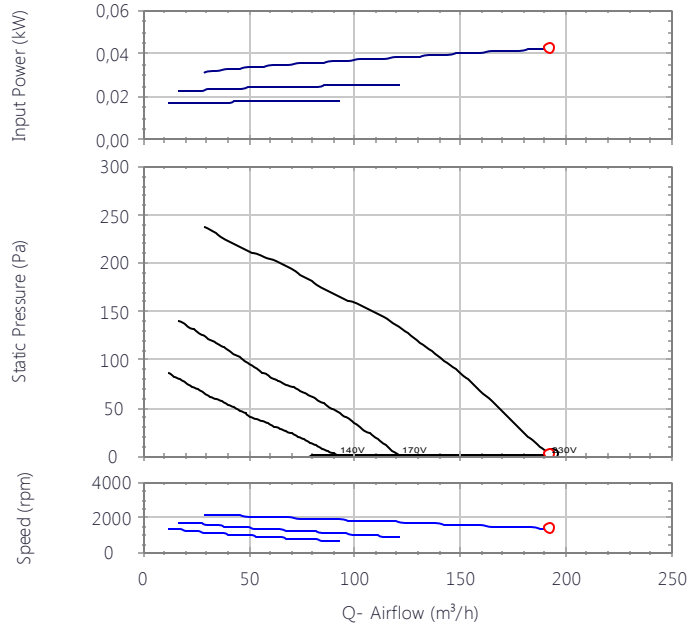

Sound Performance

	63	125	250	500	1k	2k	4k	8k	Overall
Inlet (LwA)	46	53	45	45	44	41	41	37	55
Inlet LpA @ 1m	35	42	34	34	33	30	30	26	45
Outlet (LwA)	40	56	56	59	65	63	59	57	69
Outlet LpA @ 1m	29	45	45	48	54	52	48	46	58
Breakout (LwA)	38	39	34	35	33	30	28	24	44
Breakout LpA @ 1m	27	28	23	24	22	19	17	13	33





CAB

5113862300 - CAB-100 (230V 50/60) R8 - ACOUSTIC CABINET FANS

Performance Chart

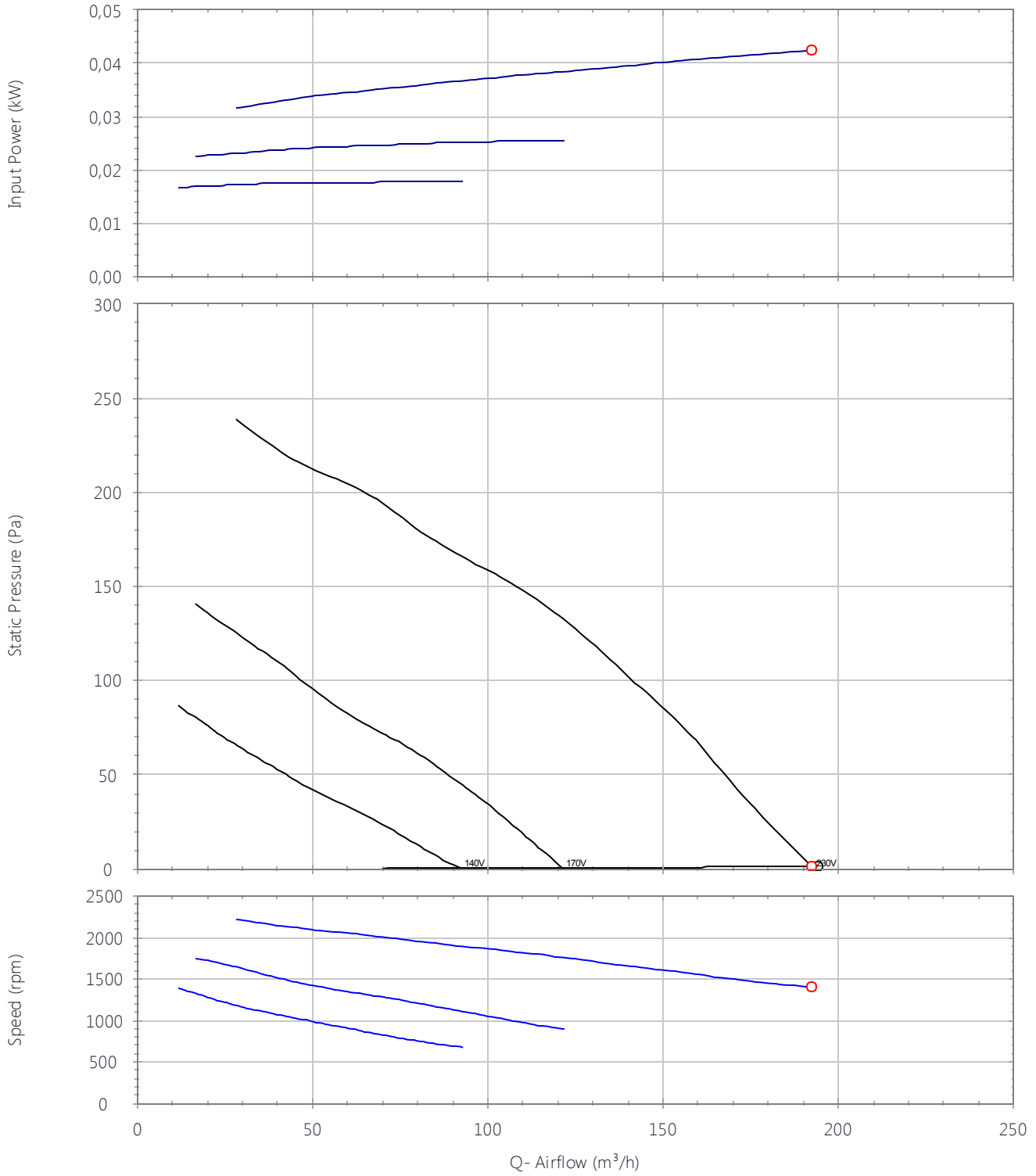



Sound Performance

	63	125	250	500	1k	2k	4k	8k	Overall
Inlet (LwA)	46	53	45	45	44	41	41	37	55
Inlet LpA @ 1m	35	42	34	34	33	30	30	26	45
Outlet (LwA)	40	56	56	59	65	63	59	57	69
Outlet LpA @ 1m	29	45	45	48	54	52	48	46	58
Breakout (LwA)	38	39	34	35	33	30	28	24	44
Breakout LpA @ 1m	27	28	23	24	22	19	17	13	33



Drawing

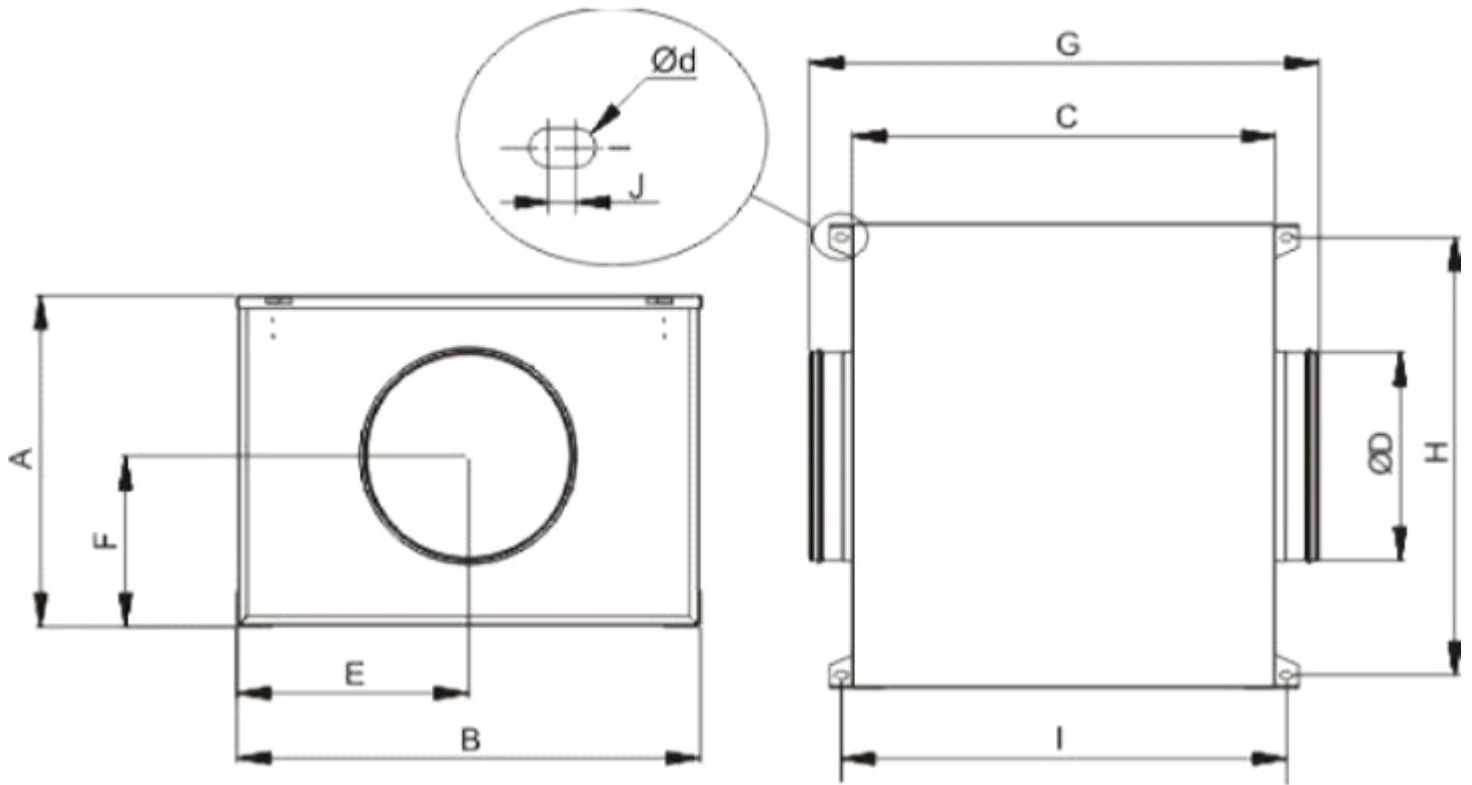

A	B	C	D	E	F	G	H	I	J	Ød
273	388	395	100	125	162	505	355	424	6.5	4.5

Accessories

L0111000000081 - REB-1 230V 50/60 ELECTRONIC SPEED CONTROLLER

Electronic single phase speed controller, 3-wire control, surface mounted, fuse protected with separate on/off switch.



Dimensions

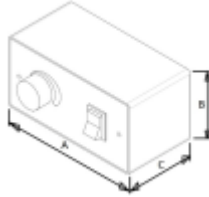

A	B	C
105	83	40

5401620900 - CONTROL ECOWATT AC/4A (230VAC 50HZ)



Control element for demand controlled ventilation systems in public, commercial residential building it automatically modifies the fan speed to adapt it to the needs defined in the system, measured with sensors. It has three basic modes of operation: 1. Integral proportional control at constant pressure. 2. Proportional control with maximum demand criteria with multiple sensor input: temperature, CO2 and relative humidity. 3. Minimum-maximum control with three-sensor input: CO2, temperature, relative humidity or presence detectors (PIR). DC signal output of 1 to 10 V or signal output for AC voltage variation for single phase motors at 230 V. ECOWATT C CONTROL: for single phase ventilation units. ECOWATT C CONTROL: for DC ventilation units. Power supply:- AC model: 1~230 V. - DC model: 1~230 V or 24 VDC..

Dimensions

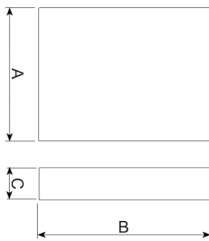

B	H	T
165	220	110

5401306500 - COM-3

Three-speed switch.Fan ON/OFF and speed selector.Maximum current rating 4A.



Dimensions

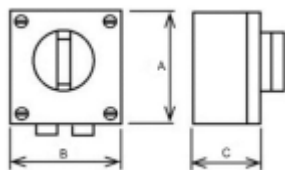

A	B	C
90	90	75



CAB

5113862300 - CAB-100 (230V 50/60) R8 - ACOUSTIC CABINET FANS

5401270300 - REB-1 N (230V 50)



Electronic speed controller

Dimensions

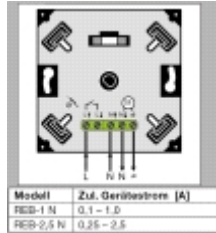

A	B	C
80	22	46

Modell	Zul. Gerätestrom [A]
REB-1 N	0,1 - 1,0
REB-2,5 N	0,25 - 2,5

5401271100 - REB-1 N E (230V 50)



Electronic speed controller

5401643000 - CONTROL ETT-6



Electronic step controller. Can control activation of up to six devices. Can be used to switch on and off heating systems (EC wall-mounted fan heaters or TERMOTECH radiant panels) or for ventilations systems with several units.

5401245500 - RMB-1,5 (220V 50Y60)

AUTOTRANSFORMER SPEED CONTROLLER



Dimensions

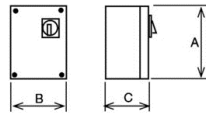

A	B	C
230	180	95

5401640600 - INTER 4P

Three speed switch.Fan ON/OFF and speed selector.Maximum current rating 4A.



Dimensions

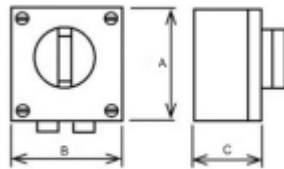

A	B	C
86	86	60.4

5211800700 - MBE-100/04B 1/230V

Electric Heater Battery



Dimensions

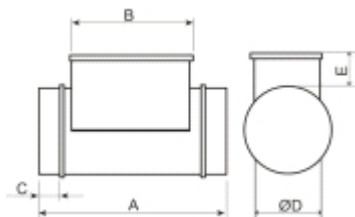

A	B	C	D	E
400	285	50	100	105



CAB

5113862300 - CAB-100 (230V 50/60) R8 - ACOUSTIC CABINET FANS

5132864000 - MBW-100

Hot-water coil



Dimensions

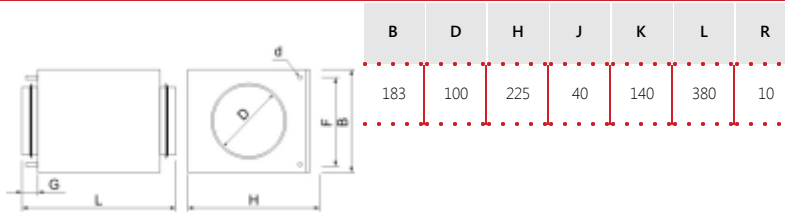

5416590700 - MFL-100 G4

IN-LINE FILTER BOX (G4 GRADE)



Dimensions

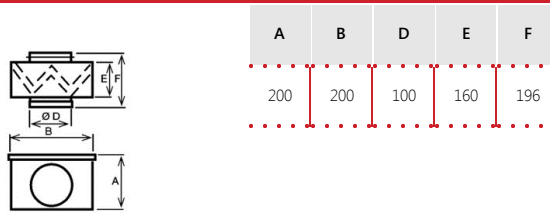

5130861700 - KSE-45

Rubber anti-vibration mounts that absorb vibration and attenuate the noise produced in the installation. (1 KSE = 4 supports in a bag)



Dimensions

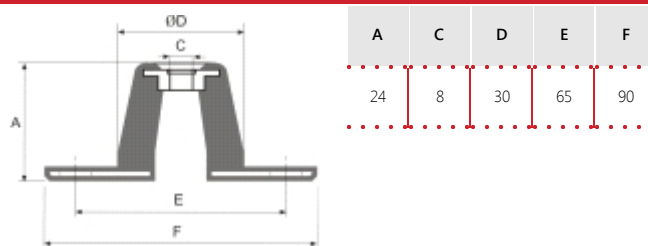

5137979000 - APC 100



Protection guards for direct connection to the inlet-outlet fan flange connector.

Dimensions

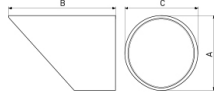

A	B
100	228

5209161900 - EC 22 N BLANCO RAL 9016

Self-regulating air vents, manufactured in white or brown polystyrene. Guaranteeing air renewal in a home through the main rooms (Living room, sitting room and bedrooms). Enabling an airflow of 22, 30 and 45 m³/h. Fitted either to carpentry elements (in openings measuring 354x12 mm) or connected to a wall feedthrough tube. The EC N air vent can have a cover that includes an insect grille, available in white or brown.



Dimensions

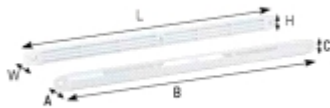

A	B	C	H	L	W
20	305	18	20	295	8

5209162000 - EC 30 N BLANCO RAL 9016

Self-regulating air vents, manufactured in white or brown polystyrene. Guaranteeing air renewal in a home through the main rooms (Living room, sitting room and bedrooms). Enabling an airflow of 22, 30 and 45 m³/h. Fitted either to carpentry elements (in openings measuring 354x12 mm) or connected to a wall feedthrough tube. The EC N air vent can have a cover that includes an insect grille, available in white or brown.



Dimensions

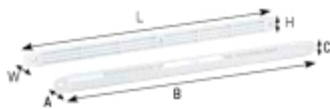

A	B	C	H	L	W
20	305	18	20	295	8

5209162100 - EC 45 N BLANCO RAL 9016

Self-regulating air vents, manufactured in white or brown polystyrene. Guaranteeing air renewal in a home through the main rooms (Living room, sitting room and bedrooms). Enabling an airflow of 22, 30 and 45 m³/h. Fitted either to carpentry elements (in openings measuring 354x12 mm) or connected to a wall feedthrough tube. The EC N air vent can have a cover that includes an insect grille, available in white or brown.



Dimensions



A	B	C	H	L	W
24	390	20	23	400	12

5209163400 - ECA 22 BLANCO RAL9016

Self-regulating air vents, manufactured from injection moulded polystyrene and available in three air volume range (22, 30, 36 and 45 m³/h). Fitted in openings measuring 354x12 mm. Suitable for installation on window joinery by crews. The air inlet acoustic element is placed on the indoor side while the cover is fitted on the external side of the joinery. An additional acoustic element can be slot into the air inlet (ECA+RA).



Dimensions



A	B	C	H	L	W
45	422	45	23	400	12

5209162500 - ECA 22 RA BLANCO RAL 9016

Self-regulating air vents, manufactured from injection moulded polystyrene. They allow air renewal in a house via main rooms (living room, dining room, bathroom). Airflow of 22, 30, 36 and 45 m³/h. It can be installed on carpentry elements or joined to a wall bypass sleeve.



Dimensions



A	B	C	H	L	W
69	422	45	23	400	12

5209163700 - ECA 30 BLANCO RAL9016

Self-regulating air vents, manufactured from injection moulded polystyrene and available in three air volume range (22, 30, 36 and 45 m³/h). Fitted in openings measuring 354x12 mm. Suitable for installation on window joinery by crews. The air inlet acoustic element is placed on the indoor side while the cover is fitted on the external side of the joinery. An additional acoustic element can be slot into the air inlet (ECA+RA).



Dimensions



A	B	C	H	L	W
45	422	45	23	400	12

5209162600 - ECA 30 RA BLANCO RAL 9016

Self-regulating air vents, manufactured from injection moulded polystyrene. They allow air renewal in a house via main rooms (living room, dining room, bathroom). Airflow of 22, 30, 36 and 45 m³/h. It can be installed on carpentry elements or joined to a wall bypass sleeve.

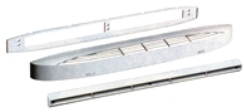

Dimensions



A	B	C	H	L	W
69	422	45	23	400	12

5209172100 - ECA 36 BLANCO RAL9016

Self-regulating air vents, manufactured from injection moulded polystyrene and available in three air volume range (22, 30, 36 and 45 m³/h). Fitted in openings measuring 354x12 mm. Suitable for installation on window joinery by crews. The air inlet acoustic element is placed on the indoor side while the cover is fitted on the external side of the joinery. An additional acoustic element can be slot into the air inlet (ECA+RA).



Dimensions



A	B	C	H	L	W
45	422	45	23	400	12

5209172200 - ECA 36 RA BLANCO RAL 9016

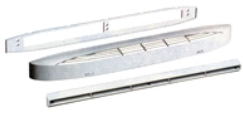

Self-regulating air vents, manufactured from injection moulded polystyrene. They allow air renewal in a house via main rooms (living room, dining room, bathroom). Airflow of 22,30, 36 and 45 m³/h. It can be installed on carpentry elements or joined to a wall bypass sleeve.

Dimensions



A	B	C	H	L	W
69	422	45	23	400	12

5209164000 - ECA 45 BLANCO RAL9016



Self-regulating air vents, manufactured from injection moulded polystyrene and available in three air volume range (22, 30, 36 and 45 m³/h). Fitted in openings measuring 354x12 mm. Suitable for installation on window joinery by crews. The air inlet acoustic element is placed on the indoor side while the cover is fitted on the external side of the joinery. An additional acoustic element can be slot into the air inlet (ECA+RA).

Dimensions



A	B	C	H	L	W
45	422	45	23	400	12

5209162700 - ECA 45 RA BLANCO RAL 9016

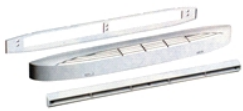

Self-regulating air vents, manufactured from injection moulded polystyrene. They allow air renewal in a house via main rooms (living room, dining room, bathroom). Airflow of 22,30, 36 and 45 m³/h. It can be installed on carpentry elements or joined to a wall bypass sleeve.

Dimensions



A	B	C	H	L	W
69	422	45	23	400	12

5209172400 - ECA HY 6/45 BLANCO RAL 9016



Humidity adjustable acoustic air vents for renewing air in the main rooms of flats and detached homes. They guarantee a variable flow of 6 to 45 m³/h according to the degree of humidity in the room, for a pressure difference of 20 Pa. It can be installed on carpentry elements or joined to a wall bypass sleeve.

Dimensions

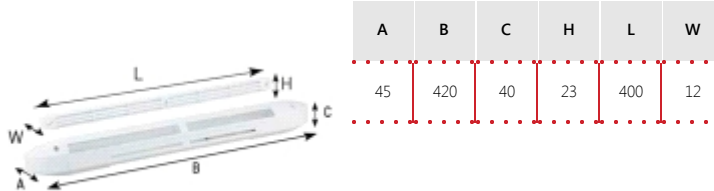

5209172500 - ECA HY 6/45 RA BLANCO RAL 9016



Humidity adjustable air vents with an acoustic frame for renewing air in the main rooms of flats and detached homes. The acoustic frame offers great noise attenuation. They guarantee a variable flow of 6 to 45 m³/h according to the degree of humidity in the room, for a pressure difference of 20 Pa. It can be installed on carpentry elements or joined to a wall bypass sleeve.

Dimensions

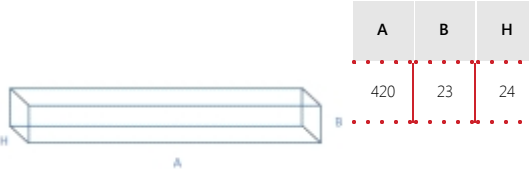

5209172300 - EC HY 6/45 BLANCO RAL 9016



Humidity adjustable air vents for renewing air in the main rooms of flats and detached homes. They guarantee a variable flow of 6 to 45 m³/h according to the degree of humidity in the room, for a pressure difference of 20 Pa. It can be installed on carpentry elements or joined to a wall bypass sleeve.

Dimensions

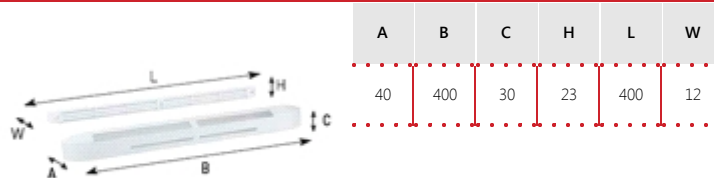



CAB

5113862300 - CAB-100 (230V 50/60) R8 - ACOUSTIC CABINET FANS

5209195800 - SILEM KIT 22



Humidity adjustable air vents with sound attenuator. SILEM KIT HY allows air renewal in a house via main rooms (living room, dining room, bathroom). Airflow of 22 and 30 m³/h They are fitted into the wall. With this purpose, it is included a sheet metal sleeve (Ø 125 mm and 300 mm length) and external facade grille.

Dimensions

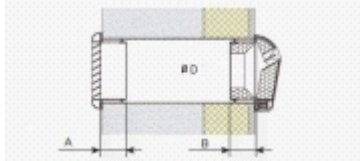

A	B	D
46	48	125

5209195900 - SILEM KIT 30



Humidity adjustable air vents with sound attenuator. SILEM KIT HY allows air renewal in a house via main rooms (living room, dining room, bathroom). Airflow of 22 and 30 m³/h They are fitted into the wall. With this purpose, it is included a sheet metal sleeve (Ø 125 mm and 300 mm length) and external facade grille.

Dimensions

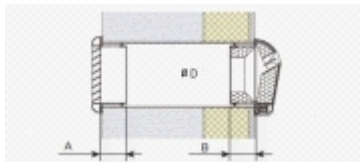

A	B	D
46	48	125

5209196100 - SILEM KIT HY 125



Humidity adjustable air vents with sound attenuator. SILEM KIT HY allows air renewal in a house via main rooms (living room, dining room, bathroom). Airflow of 22 and 30 m³/h They are fitted into the wall. With this purpose, it is included a sheet metal sleeve (Ø 125 mm and 300 mm length) and external facade grille.

Dimensions

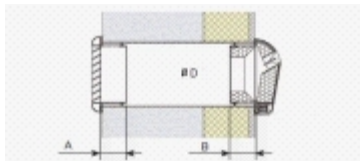

A	B	D
46	48	125



CAB

5113862300 - CAB-100 (230V 50/60) R8 - ACOUSTIC CABINET FANS

5401285100 - INTERRUPTOR PARO-MARCHA 5P



Rotatory switch. Maximum current rating 20 A. 5 wires for two speed motors. IP-66-IP-67 protection 3x380V, 440V.

Dimensions

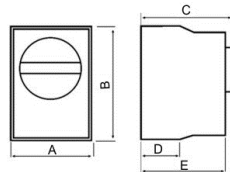

B	H	T
86	86	120

5416582400 - TG-K330 (STC)

Duct temperature sensor. Used in conjunction with electric heater and controller. NTC type with liner scale. Protection class IP20. - TG-K330: from 0 to 30°C.



5416578200 - TG-R530 (STA)

Used in conjunction with electric heaters and controllers. NTC type with liner scale. Range of temperature 0-30°C. Protection class IP30. - Room sensor without set point adjustment, 0-30°C (TG-R530).





5132868000 - TT-S1

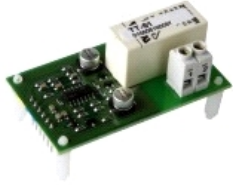

POWER AMPLIFIER

Dimensions

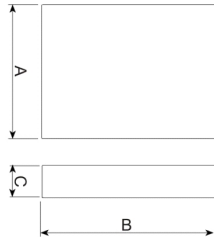

A	B	C
30	60	35

5416354800 - PULSER M



Single phase electric heater controller. Supplementary unit for slave control from another PULSER to control electric heaters with power ratings high to the PULSER capacity (3600W-230V).

Dimensions



A	B	C
83	153	40

5416365400 - PULSER-ADD



Single phase electric heater controller. Set point: 0-30°C, the sensor determines the scale range (for use with NTC-sensor). Output (load): 16 A (min. 1 A). Protection class: IP30. Input regulation maximum and minimum. Maximum absorbed power: 3.6 kW.

Dimensions



A	B	C
83	153	40



CAB

5113862300 - CAB-100 (230V 50/60) R8 - ACOUSTIC CABINET FANS

5138920100 - ACOPEL F400-120/160 N

FLEXIBLE CONNECTOR



Dimensions

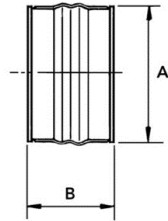

A	B
115	160

5145819800 - ACOP-VENT-100 (V977501)

FLEXIBLE CONNECTOR



5132867200 - TTC-2000 (REG-16)

ELECTRICAL HEATER BATTERY CONTROLLER



Dimensions

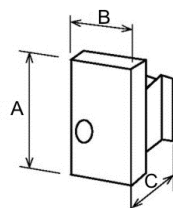

A	B	C
280	160	140

854001C09 - BEHC 10-40/90

Hygroreglable and timed extraction valves. System updated by the RT 2012, installation on horizontal or vertical walls, removable central grid for ease of maintenance, battery operated control: wireless installation. Kitchen and WC: manual, electric or ba



Dimensions



L0111000000276 - OVER RUN TIMER

Remote (wired) run-on timer, adjustable run-on time 30 seconds to 25 minutes.



Dimensions

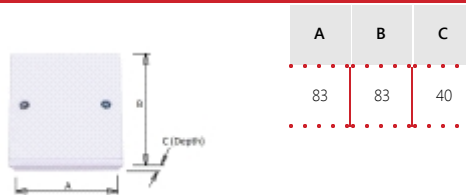

L0111000000388 - 7-DAY PROGRAMMABLE TIMECLOCK

Surface-mount digital 7-day timer.



Dimensions

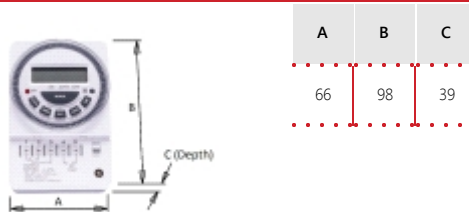



CAB

5113862300 - CAB-100 (230V 50/60) R8 - ACOUSTIC CABINET FANS

L0111000000414 - CONTACTOR INTERFACE STATION - 9A-2 x N/C AND 2 x N/O CONTACTS

9A 2 x N/O / 2 x N/C relay in IP65 enclosure for switching of fans from an external source.



Dimensions



A	B	C
110	234	149

L0111000000199 - CONTACTOR INTERFACE STATION - 9A - 4 x N/O CONTACTS

9A N/O relay in IP65 enclosure for switching of fans from an external source, particularly useful for the on/off control of 3-phase units.



Dimensions

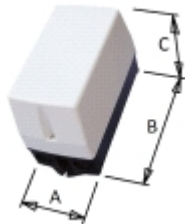

A	B	C
110	234	149

L0111000000541 - RELAY 230V COIL DPDT C/W ENCLOSURE IP65

Double-Pole, Double-throw relay in IP65 enclosure for switching of fans from an external source.



Dimensions

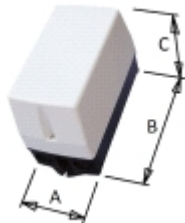

A	B	C
110	234	149

L0111000000275 - PIR SENSOR



PIR SENSOR with Volt-Free contacts and adjustable timer.

Dimensions

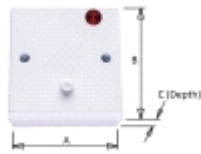

A	B	C
83	83	55

L0111000000389 - THERMOSTAT 230V INPUT



Thermostat for switching of fans by temperature, adjustable temperature range 10-30 degrees C.

Dimensions

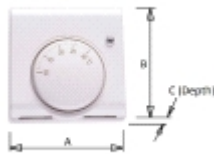

A	B	C
83	83	40

L0111000000390 - THERMOSTAT 24V INPUT



Thermostat for switching of fans by temperature, adjustable temperature range 10-30 degrees C.

Dimensions

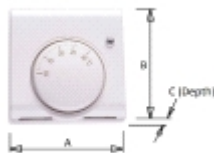

A	B	C
83	83	40



CAB

5113862300 - CAB-100 (230V 50/60) R8 - ACOUSTIC CABINET FANS

L0111000000589 - CO2 SENSOR WITH VFC (MAX 3A AT 250V) 230V



CO2 Sensor for switching of fans by Carbon Dioxide, adjustable switching points: 800ppm, 1000ppm, 1200ppm, 1400ppm.

Dimensions

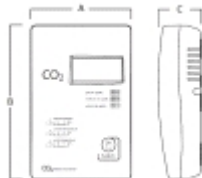

A	B	C
85	130	38.5

**CAB**

5113862300 - CAB-100 (230V 50/60) R8 - ACOUSTIC CABINET FANS



ErP Data

Ecodesign	
Commission regulation (EU) N°1253/2014 of July 2014	
Information requirements (Annex V)	
Product Name	CAB-100 (230V 50/60) R8
Identifier	5113862300
SEC average climate (kWh/(m2.an))	-24,71
SEC class	C
SEC cold climate (kWh/(m2.an))	-52
SEC warm climate (kWh/(m2.an))	-9
Typology	RVU unidirectional
Type of drive	Variable speed drive
Type of HRC	None
Thermal efficiency (%)	0
Maximum flow rate (m3/h)	141
Electrical power input at maximum flow rate (W)	39,62
Sound power level (LWA)	37
Reference flow rate (m3/s)	0,0278
Reference pressure difference (Pa)	50
SPI (W/m3/h)	0,2717
Control factor	0,65
Control typology	Local demand
Maximum internal leakage for BVU (%)	Not applicable
Maximum external leakage for BVU and UVU (%)	5
Mixing rate for BVU without duct connection (%)	Not applicable
Position of visual filter warning	Not applicable
description of visual filter warning	Not applicable
Instructions to install supply grilles	F&W Leaflet
Instructions to install exhaust grilles	F&W Leaflet
https://www.solerpalau.com/	
Airflow sensitivity to pressure variation	Not applicable
Indoor/outdoor air tightness (m3/h)	Not applicable
Annual electricity consumption - Average climate (kWh/a)	143,78
Annual electricity consumption - Warm climate (kWh/a)	143,78
Annual electricity consumption - Cold climate (kWh/a)	143,78
Annual heating saved - Average climate (kWh/a)	2830
Annual heating saved - Warm climate (kWh/a)	1279,69
Annual heating saved - Cold climate (kWh/a)	5536,23

Warnings

This dimensional drawing may not match with the selected product, especially in the discharge orientation