



CAB-ECOWATT

5113862800 - CAB-125 ECOWATT 230V50/60HZ N8 - ACOUSTIC CABINET FANS



Low profile acoustic cabinet fans, manufactured from galvanised sheet steel and internally lined with 50mm thickness of fireproof acoustic insulation (M0), with sound-absorbent insulation at the inlet. All models incorporate inlet and discharge circular duct connection flanges with integrated rubber air seal. Direct drive backward curved centrifugal fan. Brushless EC motor, IP44, class B, with thermal overload protection, suitable for single phase supply 230V +/- 15%-50/60Hz. Fan supply with external ON-OFF electrical isolation switch, and potentiometer to adjust the fan speed. Also possible to control the fan speed with external potentiometer type REB-ECOWATT or analogue input signal 0-10V. This cabinet fan has been designed for indoor use, with inlet air temperatures between -20°C up to +40°C and suitable for mounting in any orientation. Brand S&P model CAB-125 ECOWATT 230V50/60HZ N8.

Theoretical Working Point

Airflow	-
Static Pressure	0,000 Pa
Temperature	20 °C
Altitude	0 m
Density	1,2 kg/m ³
Frequency	50/60 Hz

Construction

Discharge diameter	125 mm
Fan size	125
Weight	13,00 kg

Motor Characteristics

Voltage	1-230V-50Hz
Maximum absorbed current	0,5 A
IP Rating	IP44
Motor insulation class	B



CAB-ECOWATT

5113862800 - CAB-125 ECOWATT 230V50/60HZ N8 - ACOUSTIC CABINET FANS



Performance Chart

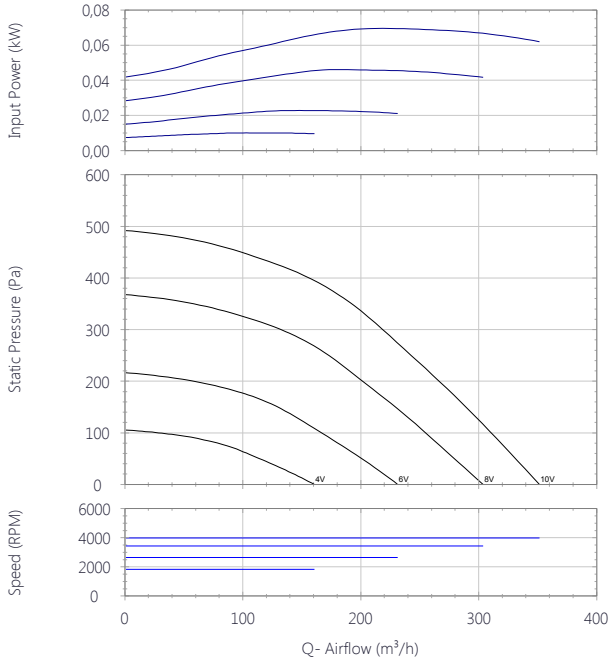

Drawing

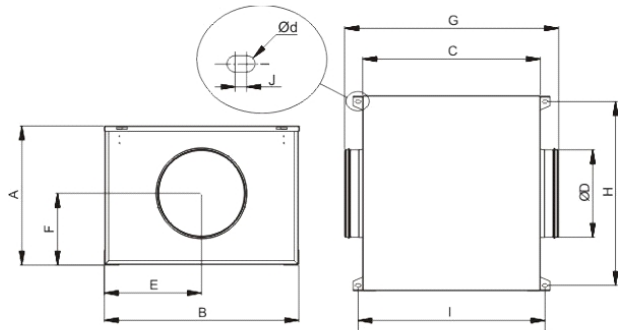

A	B	C	D	E	F	G	H	I
316	420	386	125	210	163	433	389	412

J	d
6.5	4.5

Sound Performance

	63	125	250	500	1k	2k	4k	8k	Overall
Inlet (LwA)	39	47	52	60	61	60	55	57	66
Inlet LpA @ 1m	28	36	41	49	50	49	44	46	55
Outlet (LwA)	40	49	50	51	56	57	55	48	62
Outlet LpA @ 1m	29	38	39	40	45	46	44	37	51
Breakout (LwA)	40	47	46	43	41	44	42	40	53
Breakout LpA @ 1m	29	36	35	32	30	33	31	29	42



Q=1



CAB-ECOWATT

5113862800 - CAB-125 ECOWATT 230V50/60HZ N8 - ACOUSTIC CABINET FANS

Performance Chart

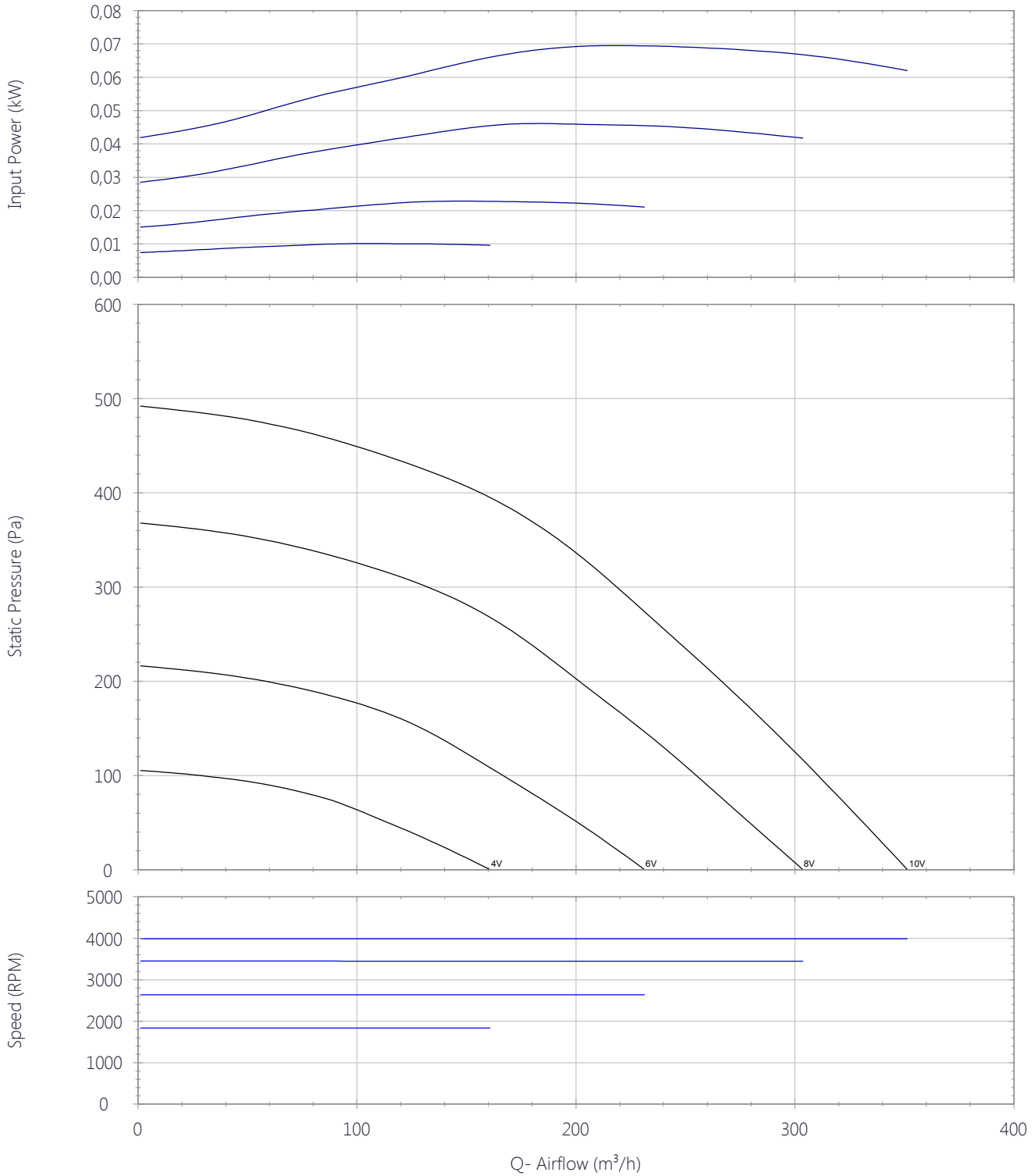



CAB-ECOWATT

5113862800 - CAB-125 ECOWATT 230V50/60HZ N8 - ACOUSTIC CABINET FANS

Sound Performance

	63	125	250	500	1k	2k	4k	8k	Overall
Inlet (LwA)	39	47	52	60	61	60	55	57	66
Inlet LpA @ 1m	28	36	41	49	50	49	44	46	55
Outlet (LwA)	40	49	50	51	56	57	55	48	62
Outlet LpA @ 1m	29	38	39	40	45	46	44	37	51
Breakout (LwA)	40	47	46	43	41	44	42	40	53
Breakout LpA @ 1m	29	36	35	32	30	33	31	29	42





CAB-ECOWATT

5113862800 - CAB-125 ECOWATT 230V50/60HZ N8 - ACOUSTIC CABINET FANS

Drawing

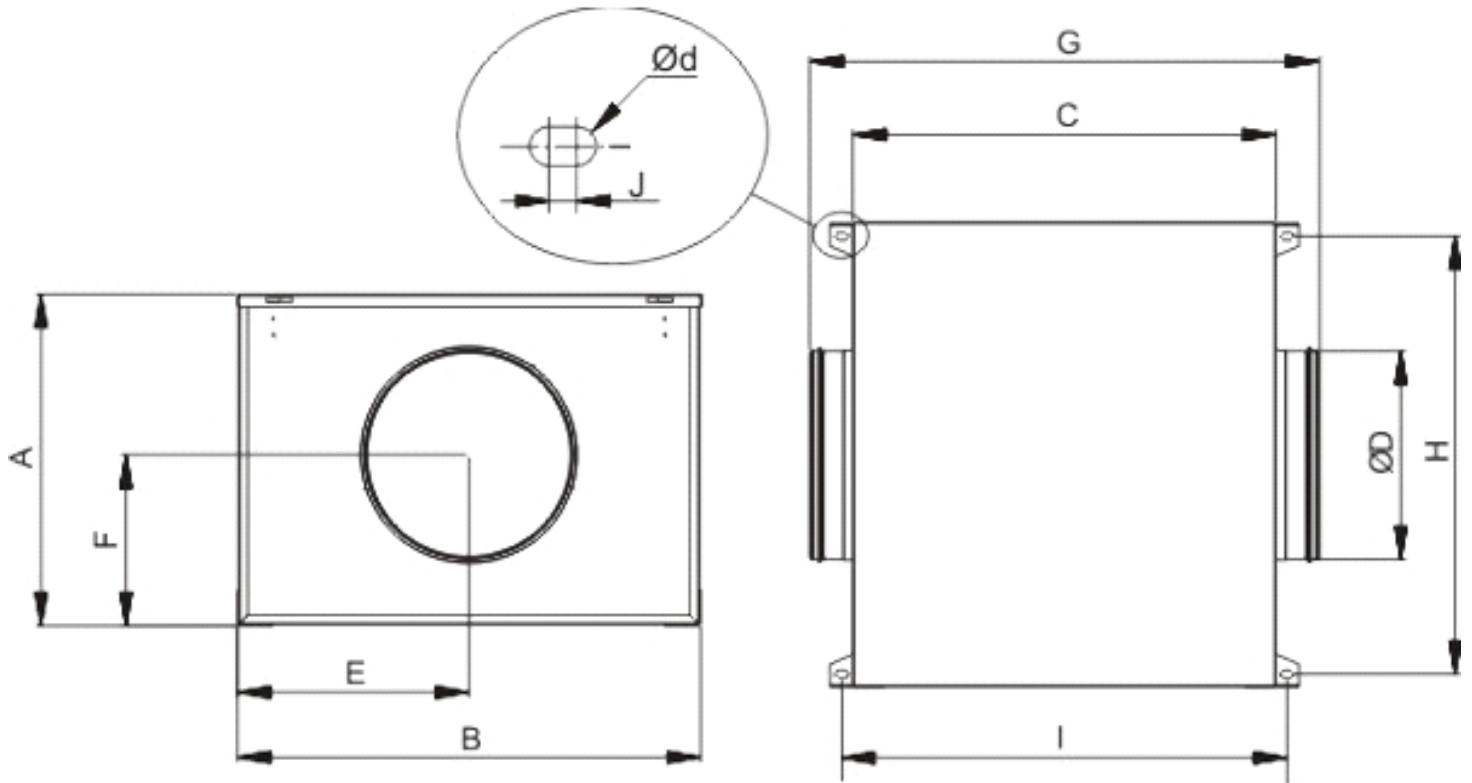

A	B	C	D	E	F	G	H	I	J	d
316	420	386	125	210	163	433	389	412	6.5	4.5

Accessories

5211808400 - MBE-125/04B 1/230V



Electric Heater Battery

Dimensions

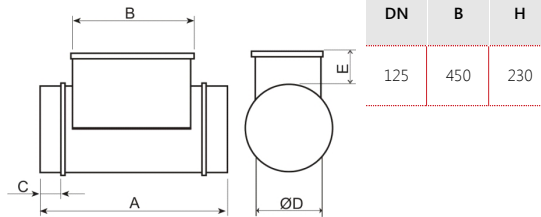

5416591500 - MFL-125 G4



MFL filtration boxes are of G4 grade filtration and are designed for direct connection with standard circular ducting. The MFL-G4 filtration boxes are supplied with a cover easily removable to replace the filter.

Dimensions

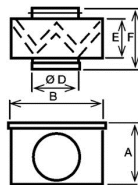

A	B	D	E	d
206	229	125	154	218

5130861700 - KSE-45

Rubber anti-vibration mounts that absorb vibration and attenuate the noise produced in the installation. (1 KSE = 4 supports in a bag)



Dimensions

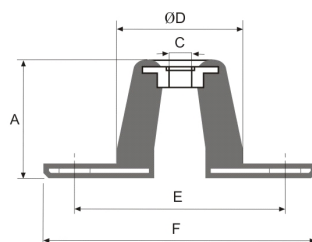

A	C	D	E	F
24	8	30	65	90



CAB-ECOWATT

5113862800 - CAB-125 ECOWATT 230V50/60HZ N8 - ACOUSTIC CABINET FANS

5137914700 - APC 125

Protection guards for direct connection to the inlet-outlet fan flange connector.



Dimensions

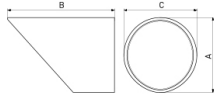

A	B
125	232

5416731100 - SCHAT-AD

SCHAT-AD: Ambient CO2 sensor, temperature and relative humidity with display.



Dimensions

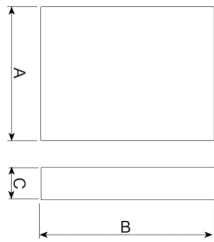

A	B	C
85	26	100

5211809800 - SIL-125

Silencer to be installed either at the inlet or outlet of the fan.



Corrections

63	125	250	500	1k	2k	4k	8k
-4	-6	-10	-19	-28	-33	-25	-18

Dimensions

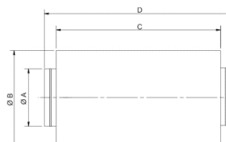

A	B	C	D
125	225	600	700



CAB-ECOWATT

5113862800 - CAB-125 ECOWATT 230V50/60HZ N8 - ACOUSTIC CABINET FANS

5416844700 - TDP-PI



TDP-D: Pressure sensor, with display. Enables you to control the pressure in the fan inlet.

Dimensions

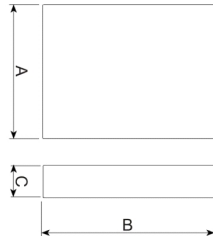

B	H	T
11	130	65

L011100000276 - OVER RUN TIMER



Remote (wired) run-on timer, adjustable run-on time 30 seconds to 25 minutes.

Dimensions

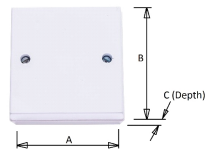

A	B	C
83	83	40

L011100000388 - 7-DAY PROGRAMMABLE TIMECLOCK



Surface-mount digital 7-day timer.

Dimensions

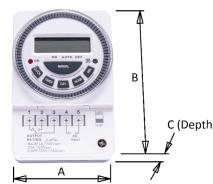

A	B	C
66	98	39



CAB-ECOWATT

5113862800 - CAB-125 ECOWATT 230V50/60HZ N8 - ACOUSTIC CABINET FANS

L011100000414 - CONTACTOR INTERFACE STATION - 9A-2 x N/C AND 2 x N/O CONTACTS

9A 2 x N/O / 2 x N/C relay in IP65 enclosure for switching of fans from an external source.



Dimensions

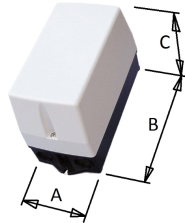

A	B	C
110	234	149

L011100000199 - CONTACTOR INTERFACE STATION - 9A - 4 x N/O CONTACTS

9A N/O relay in IP65 enclosure for switching of fans from an external source, particularly useful for the on/off control of 3-phase units.



Dimensions

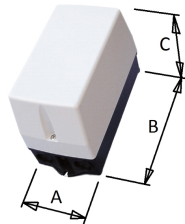

A	B	C
110	234	149

L011100000541 - RELAY 230V COIL DPDT C/W ENCLOSURE IP65

Double-Pole, Double-throw relay in IP65 enclosure for switching of fans from an external source.



Dimensions

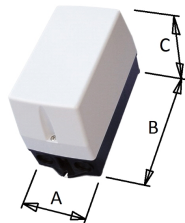

A	B	C
110	234	149



CAB-ECOWATT

5113862800 - CAB-125 ECOWATT 230V50/60HZ N8 - ACOUSTIC CABINET FANS

L011100000275 - PIR SENSOR



PIR SENSOR with Volt-Free contacts and adjustable timer.

Dimensions

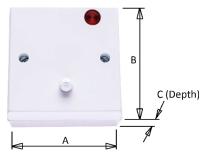

A	B	C
83	83	55

L011100000957 - S&P MULTI-REG EC FAN CONTROLLER / INTERFACE



Fan controller to provide demand ventilation speed control for dedicated control of the S&P ECOWATT EC ranges and full BMS compatibility.

Dimensions

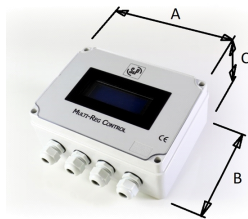

A	B	C
196	145	82

L011100000389 - THERMOSTAT 230V INPUT



Thermostat for switching of fans by temperature, adjustable temperature range 10-30 degrees C.

Dimensions

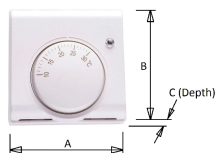

A	B	C
83	83	40



CAB-ECOWATT

5113862800 - CAB-125 ECOWATT 230V50/60HZ N8 - ACOUSTIC CABINET FANS

L0111000000390 - THERMOSTAT 24V INPUT



Thermostat for switching of fans by temperature, adjustable temperature range 10-30 degrees C.

Dimensions

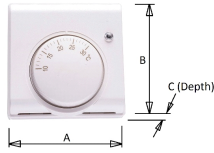

A	B	C
83	83	40



CAB-ECOWATT

5113862800 - CAB-125 ECOWATT 230V50/60HZ N8 - ACOUSTIC CABINET FANS

ErP Data

Ecodesign	
Commission regulation (EU) N°1253/2014 of July 2014	
Information requirements (Annex V)	
Product description	CAB-125 ECOWATT 230V50/60HZ N8
Manufacturer's Info	S&P
Identifier	-
Typology	NRVU unidirectional
Drive	VSD
Type of HRC	None
Thermal efficiency (%)	NA
Qnom (m3/s)	0,06
Pelec (kW)	0,05
SFPint (W/m3/s)	NA
Face velocity (m/s)	0,66
$\Delta p_{s,ext}$ (Pa)	217,1
$\Delta p_{s,int}$ (Pa)	NA
$\Delta p_{s,add}$ (Pa)	NA
Static efficiency fans (%)	39,2
External leakage rate (%)	3
Internal leakage rate (%)	NA
Filter performance	NA
Filter warning	NA
LWA dB(A)	54
https://www.solerpalau.com/	