



# CAB-ECOWATT

5113863300 - CAB-315 ECOWATT 230V50/60HZ N8 - ACOUSTIC CABINET FANS



Low profile acoustic cabinet fans, manufactured from galvanised sheet steel and internally lined with 50mm thickness of fireproof acoustic insulation (M0), with sound-absorbent insulation at the inlet. All models incorporate inlet and discharge circular duct connection flanges with integrated rubber air seal. Direct drive backward curved centrifugal fan. Brushless EC motor, IP44, class B, with thermal overload protection, suitable for single phase supply 230V +/- 15%-50/60Hz. Fan supply with external ON-OFF electrical isolation switch, and potentiometer to adjust the fan speed. Also possible to control the fan speed with external potentiometer type REB-ECOWATT or analogue input signal 0-10V. This cabinet fan has been designed for indoor use, with inlet air temperatures between -20°C up to +40°C and suitable for mounting in any orientation. Brand S&P model CAB-315 ECOWATT 230V50/60HZ N8.

## Theoretical Working Point

Airflow	-
Static Pressure	0,000 Pa
Temperature	20 °C
Altitude	0 m
Density	1,2 kg/m <sup>3</sup>
Frequency	50/60 Hz

## Construction

Discharge diameter	315 mm
Fan size	315
Weight	28,50 kg

## Motor Characteristics

Voltage	1-230V-50Hz
Maximum absorbed current	1,0 A
IP Rating	IP44
Motor insulation class	B



# CAB-ECOWATT

5113863300 - CAB-315 ECOWATT 230V50/60HZ N8 - ACOUSTIC CABINET FANS



## Performance Chart

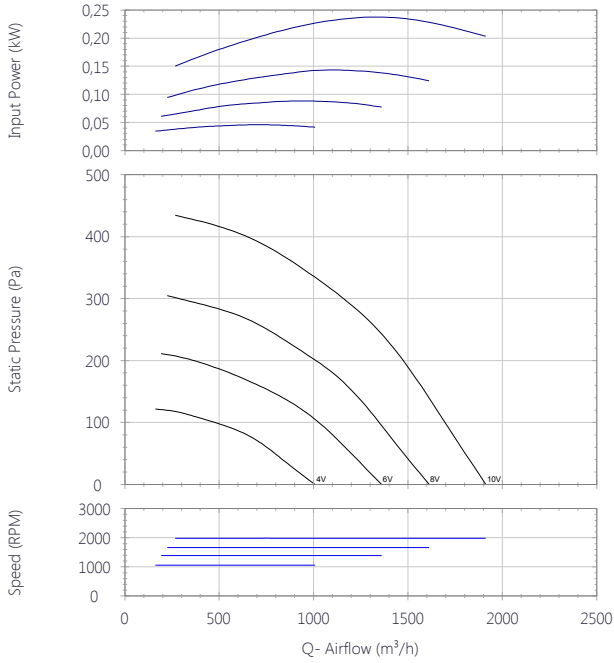

## Drawing

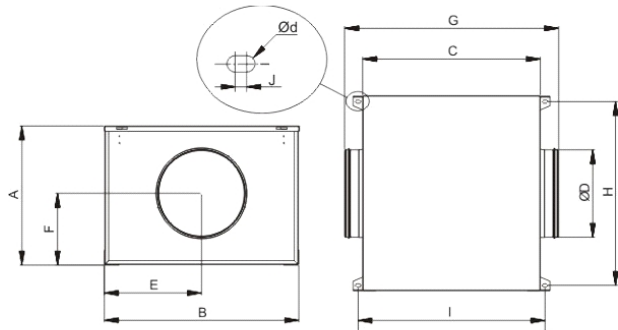

A	B	C	D	E	F	G	H	I
441	609	555	315	305	221	659	585	580

J	d
6.5	4.5

## Sound Performance

	63	125	250	500	1k	2k	4k	8k	Overall
<b>Inlet (LwA)</b>	41	54	67	67	66	63	59	57	72
<b>Inlet LpA @ 1m</b>	30	43	56	56	55	52	48	46	61
<b>Outlet (LwA)</b>	47	57	66	59	64	60	53	46	70
<b>Outlet LpA @ 1m</b>	36	46	55	48	53	49	42	35	59
<b>Breakout (LwA)</b>	42	48	65	54	57	54	49	46	66
<b>Breakout LpA @ 1m</b>	31	37	54	43	46	43	38	35	55



Q=1



# CAB-ECOWATT

5113863300 - CAB-315 ECOWATT 230V50/60HZ N8 - ACOUSTIC CABINET FANS

## Performance Chart

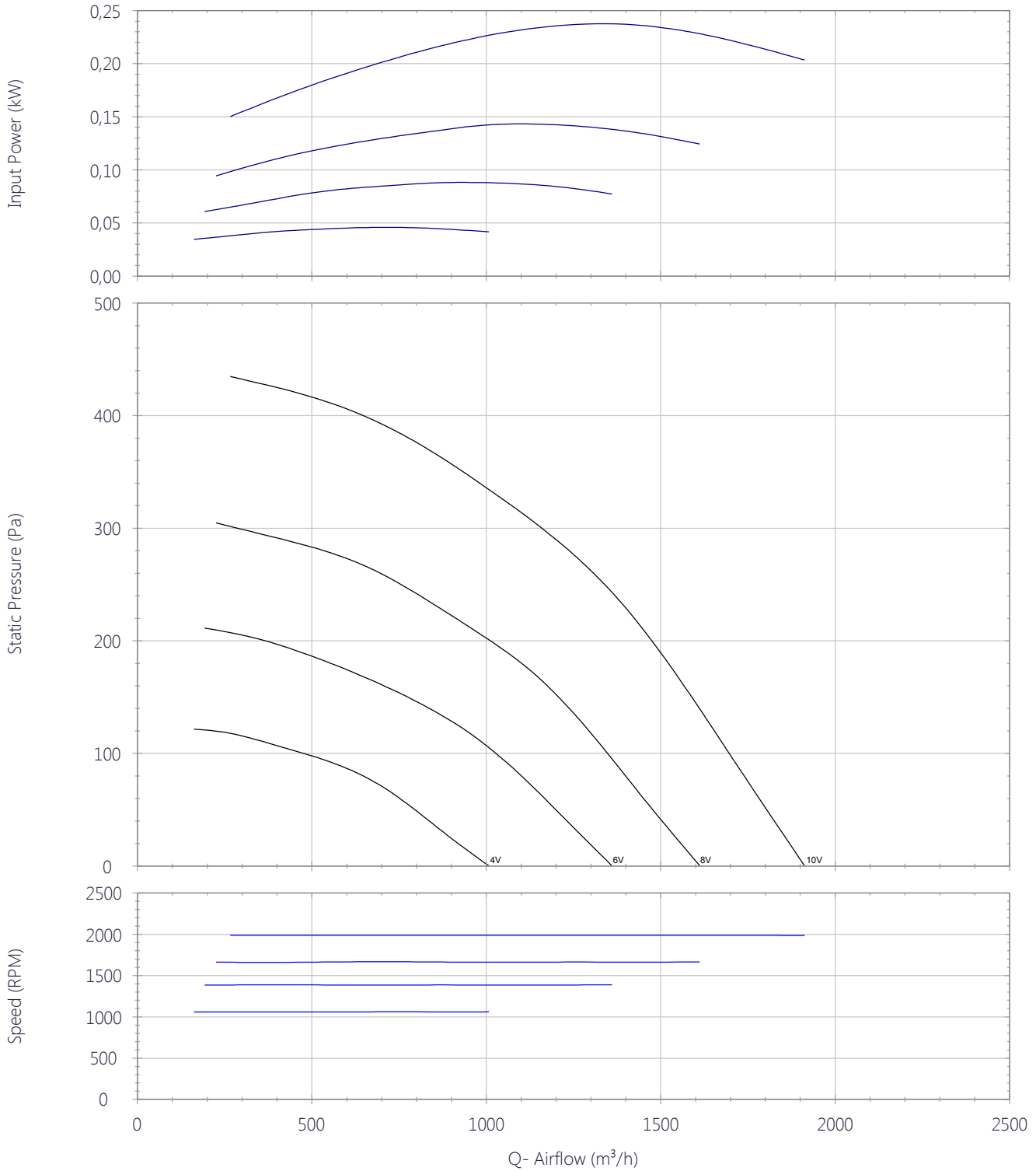



# CAB-ECOWATT

5113863300 - CAB-315 ECOWATT 230V50/60HZ N8 - ACOUSTIC CABINET FANS

## Sound Performance

	63	125	250	500	1k	2k	4k	8k	Overall
<b>Inlet (LwA)</b>	41	54	67	67	66	63	59	57	72
<b>Inlet LpA @ 1m</b>	30	43	56	56	55	52	48	46	61
<b>Outlet (LwA)</b>	47	57	66	59	64	60	53	46	70
<b>Outlet LpA @ 1m</b>	36	46	55	48	53	49	42	35	59
<b>Breakout (LwA)</b>	42	48	65	54	57	54	49	46	66
<b>Breakout LpA @ 1m</b>	31	37	54	43	46	43	38	35	55





# CAB-ECOWATT

5113863300 - CAB-315 ECOWATT 230V50/60HZ N8 - ACOUSTIC CABINET FANS

## Drawing

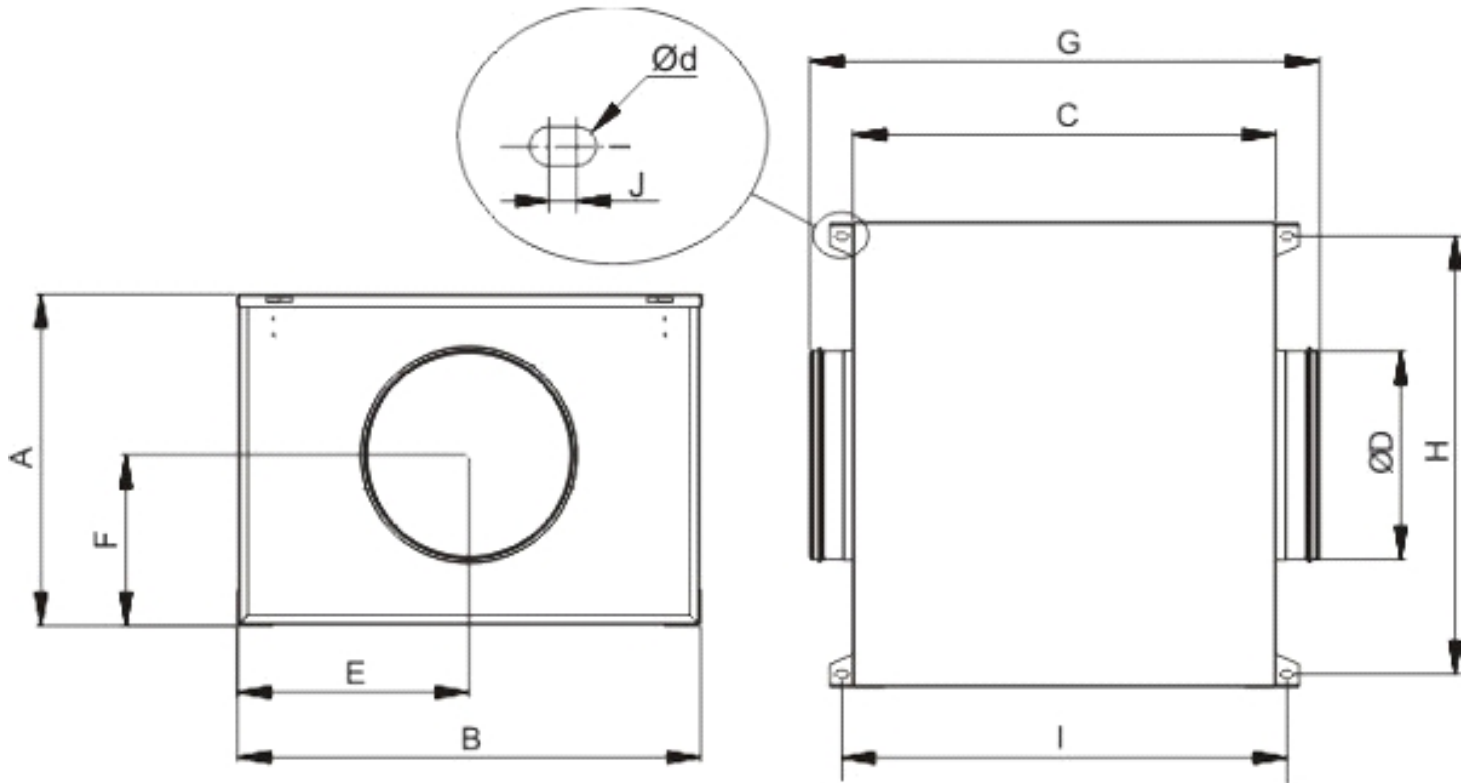

A	B	C	D	E	F	G	H	I	J	d
441	609	555	315	305	221	659	585	580	6.5	4.5

## Accessories

5211799100 - MBE-315/30T 2/400V



Electric Heater Battery

### Dimensions

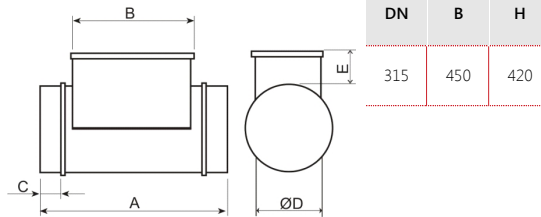

5416581600 - MFL-315 G4



MFL filtration boxes are of G4 grade filtration and are designed for direct connection with standard circular ducting. The MFL-G4 filtration boxes are supplied with a cover easily removable to replace the filter.

### Dimensions

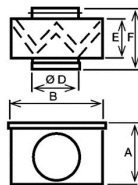

A	B	D	E	F
346	369	315	154	248

5130861700 - KSE-45

Rubber anti-vibration mounts that absorb vibration and attenuate the noise produced in the installation. (1 KSE = 4 supports in a bag)



### Dimensions

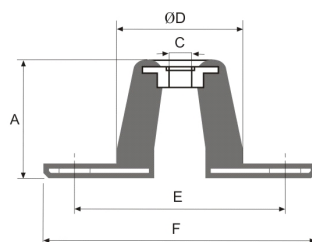

A	C	D	E	F
24	8	30	65	90



# CAB-ECOWATT

5113863300 - CAB-315 ECOWATT 230V50/60HZ N8 - ACOUSTIC CABINET FANS

5416731100 - SCHAT-AD



SCHAT-AD: Ambient CO2 sensor, temperature and relative humidity with display.

### Dimensions

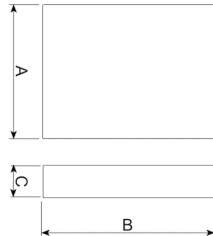

A	B	C
85	26	100

5211813000 - SIL-315

Silencer to be installed either at the inlet or outlet of the fan.



### Corrections

63	125	250	500	1k	2k	4k	8k
-0	-1	-4	-10	-12	-7	-4	-4

### Dimensions

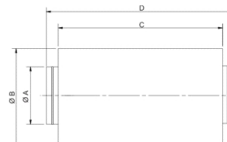

A	B	C	D
315	415	600	700

5416730200 - REMP-315

Motorized shutter



### Dimensions

D	axle	L	MH
315	12	300	80



# CAB-ECOWATT

5113863300 - CAB-315 ECOWATT 230V50/60HZ N8 - ACOUSTIC CABINET FANS



5138920900 - ACOPEL F400-315/160 N

FLEXIBLE CONNECTOR



### Dimensions

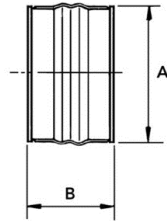

A	B
323	160

5416844700 - TDP-PI

TDP-D: Pressure sensor, with display. Enables you to control the pressure in the fan inlet.



### Dimensions

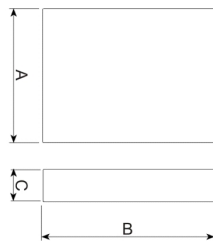

B	H	T
11	130	65

L011100000276 - OVER RUN TIMER

Remote (wired) run-on timer, adjustable run-on time 30 seconds to 25 minutes.



### Dimensions

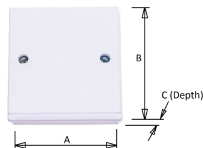

A	B	C
83	83	40



## L011100000388 - 7-DAY PROGRAMMABLE TIMECLOCK



Surface-mount digital 7-day timer.

### Dimensions

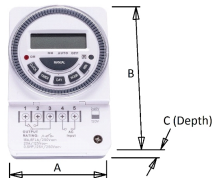

A	B	C
66	98	39

## L011100000414 - CONTACTOR INTERFACE STATION -9A-2 x N/C AND 2 x N/O CONTACTS



9A 2 x N/O / 2 x N/C relay in IP65 enclosure for switching of fans from an external source.

### Dimensions

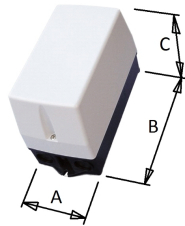

A	B	C
110	234	149

## L011100000199 - CONTACTOR INTERFACE STATION - 9A - 4 x N/O CONTACTS



9A N/O relay in IP65 enclosure for switching of fans from an external source, particularly useful for the on/off control of 3-phase units.

### Dimensions

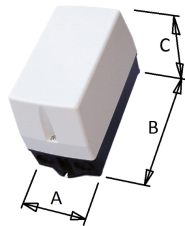

A	B	C
110	234	149



# CAB-ECOWATT

5113863300 - CAB-315 ECOWATT 230V50/60HZ N8 - ACOUSTIC CABINET FANS

## L0111000000541 - RELAY 230V COIL DPDT C/W ENCLOSURE IP65

Double-Pole, Double-throw relay in IP65 enclosure for switching of fans from an external source.



### Dimensions

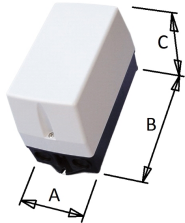

A	B	C
110	234	149

## L0111000000275 - PIR SENSOR

PIR SENSOR with Volt-Free contacts and adjustable timer.



### Dimensions

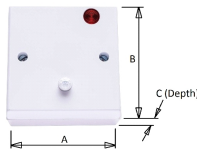

A	B	C
83	83	55

## L0111000000957 - S&P MULTI-REG EC FAN CONTROLLER / INTERFACE

Fan controller to provide demand ventilation speed control for dedicated control of the S&P ECOWATT EC ranges and full BMS compatibility.



### Dimensions

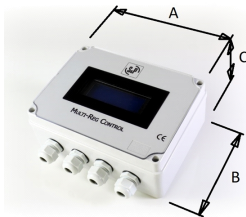

A	B	C
196	145	82



# CAB-ECOWATT

5113863300 - CAB-315 ECOWATT 230V50/60HZ N8 - ACOUSTIC CABINET FANS

## L0111000000389 - THERMOSTAT 230V INPUT



Thermostat for switching of fans by temperature, adjustable temperature range 10-30 degrees C.

### Dimensions

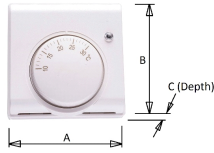

A	B	C
83	83	40

## L0111000000390 - THERMOSTAT 24V INPUT



Thermostat for switching of fans by temperature, adjustable temperature range 10-30 degrees C.

### Dimensions

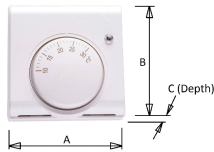

A	B	C
83	83	40



# CAB-ECOWATT

5113863300 - CAB-315 ECOWATT 230V50/60HZ N8 - ACOUSTIC CABINET FANS

## ErP Data

Ecodesign	
Commission regulation (EU) N°1253/2014 of July 2014	
Information requirements (Annex V)	
Product description	CAB-315 ECOWATT 230V50/60HZ N8
Manufacturer's Info	S&P
Identifier	-
Typology	NRVU unidirectional
Drive	VSD
Type of HRC	None
Thermal efficiency (%)	NA
Qnom (m3/s)	0,3
Pelec (kW)	0,23
SFPint (W/m3/s)	NA
Face velocity (m/s)	1,46
$\Delta p_{s,ext}$ (Pa)	317,9
$\Delta p_{s,int}$ (Pa)	NA
$\Delta p_{s,add}$ (Pa)	NA
Static efficiency fans (%)	64,2
External leakage rate (%)	3
Internal leakage rate (%)	NA
Filter performance	NA
Filter warning	NA
LWA dB(A)	66
<a href="https://www.solerpalau.com/">https://www.solerpalau.com/</a>	