



Low profile acoustic cabinet fans, manufactured from galvanised sheet steel and internally lined with 50mm thickness of fireproof acoustic fiberglass insulation (M0), with sound-absorbent insulation at the inlet and fitted with inlet and discharge circular duct connection flanges with integrated rubber air seal. All model include an enclosed type, single-phase external rotor motor with factory matched backward curved nonstalling impeller. Impellers are manufactured from injection moulded plastic.

Motors

From CAB-125B to 160B, all motors are IP44, Class B, with ball bearings and thermal protection.

CAB-200B and 250B, motors are IP44, Class F, with ball bearings and thermal protection.

Electrical supply:

Single phase 230V-50/60Hz.
 Speed controllable using voltage regulation.



IP55 terminal box
 To ease installation and connection to external controls.



Low noise level
 Acoustic insulation of 50 mm thickness fireproof fibreglass (M0) with a high resistance coating reducing the noise level significantly.



Sound-absorbent insulation at the inlet.

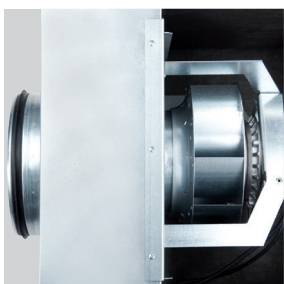

Direct drive backward centrifugal impeller
 The impeller is factory matched to the external rotor motor.

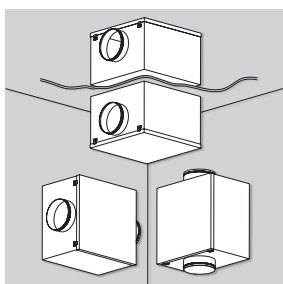

Installation in any orientation
 Possibility to be installed upright, horizontal or inverted.

TECHNICAL CHARACTERISTICS

Before installation check that the product electrical characteristics listed on the data plate label (voltage, power, frequency, etc.) match those of the intended electrical supply.

Model	Speed (RPM)	Maximum absorbed power (W)	Maximum absorbed current (A)	Maximum airflow (m³/h)	Sound pressure level** (dB(A))			Min-Max air temperature (°C)	Weight (kg)	Speed controller	Wiring diagram (n°)
					Inlet	Outlet	Radiated*				
CAB-125B	2550	65	0,3	390	45	40	35	-20/+50	13	REB-1N	50
CAB-150B	2590	63	0,3	420	45	40	36	-20/+50	15	REB-1N	50
CAB-160B	2620	64	0,3	430	45	40	36	-20/+50	15	REB-1N	50
CAB-200B	2620	157	0,8	920	53	47	40	-20/+70	22	REB-1N	50
CAB-250B	2620	225	1,2	1220	56	49	42	-20/+70	25	REB-2,5N	50

* Fan ducted on both inlet and outlet sides.

** Sound pressure levels measured at 1,5m in free field condition at a medium working point of the performance curve

DIMENSIONS (mm)

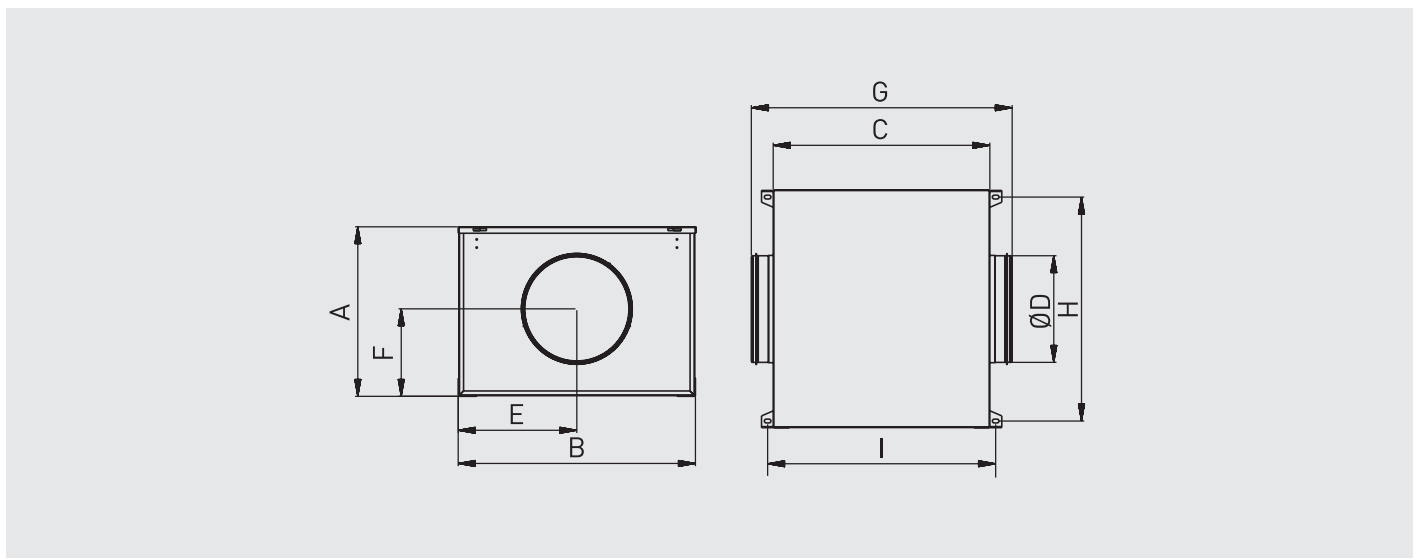

Model	A	B	C	D	E	F	G	H	I
CAB-125B	316	420	386	125	210	163	433	389	412
CAB-150B	334	447	415	150	224	174	517	416	441
CAB-160B	334	447	415	160	224	174	517	416	441
CAB-200B	375	510	468	200	255	193	570	479	494
CAB-250B	395	553	505	250	277	204	608	522	535

PERFORMANCE CURVES

- q_v : Airflow in m^3/h .
- p_{sf} : Static pressure in Pa.
- SFP: Specific fan power in $W/m^3/s$ (blue curves).
- Dry air at $20^\circ C$ and 760 mmHg .
- Performance data in accordance with ISO 5801 and AMCA 210-99 Standards.

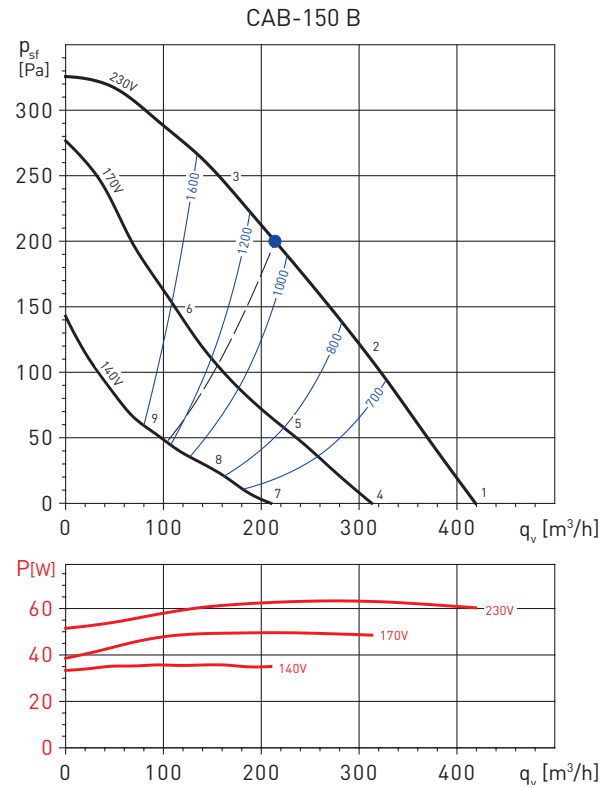
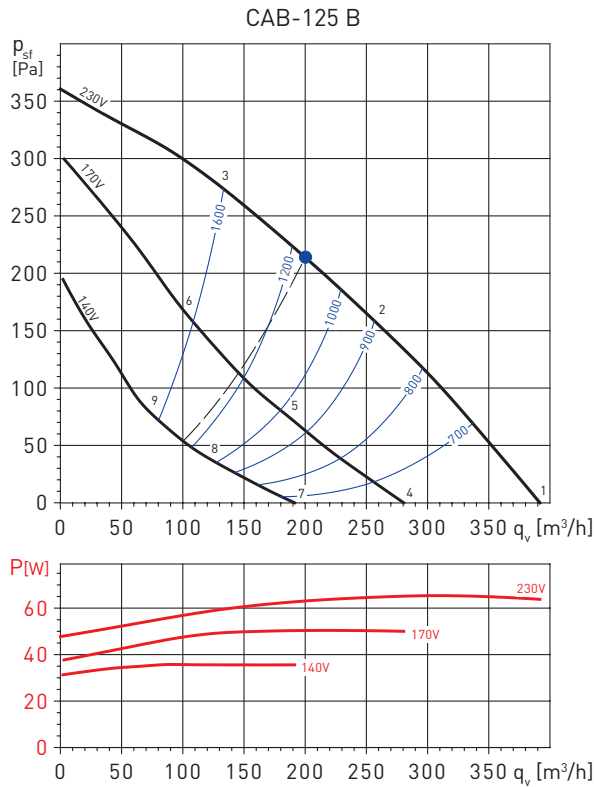

Sound power level spectrums in dB(A)

Working point	63	125	250	500	1.000	2.000	4.000	8.000	LwA	
1	Inlet	36	41	53	54	55	54	53	46	61
	Outlet	35	45	51	46	51	49	46	38	57
	Break-Out	36	38	46	40	42	44	44	38	51
2	Inlet	34	40	54	53	54	52	49	44	60
	Outlet	31	41	51	43	48	47	43	36	55
	Break-Out	34	36	46	38	40	41	39	34	49
3	Inlet	31	41	55	55	56	52	49	43	61
	Outlet	31	42	49	43	48	47	43	37	54
	Break-Out	30	37	46	40	42	40	38	33	50
4	Inlet	32	40	49	49	52	50	48	40	57
	Outlet	30	41	46	42	47	44	40	31	52
	Break-Out	32	37	41	36	39	41	39	35	47
5	Inlet	30	39	49	49	50	49	46	39	56
	Outlet	27	40	47	40	45	42	37	30	51
	Break-Out	30	37	41	36	38	39	37	34	46
6	Inlet	27	38	49	48	50	47	43	36	55
	Outlet	25	38	46	39	44	42	37	30	50
	Break-Out	27	35	40	34	37	36	34	30	45
7	Inlet	29	37	43	45	46	46	41	33	52
	Outlet	27	38	43	39	42	39	33	26	48
	Break-Out	29	34	38	32	35	37	32	28	43
8	Inlet	25	36	42	44	45	43	37	30	50
	Outlet	23	37	42	38	39	36	30	25	46
	Break-Out	26	33	38	32	35	35	30	26	42
9	Inlet	25	36	43	44	45	42	35	28	50
	Outlet	23	38	42	37	39	35	29	25	46
	Break-Out	24	33	38	31	34	33	27	23	42

Sound power level spectrums in dB(A)

Working point	63	125	250	500	1.000	2.000	4.000	8.000	LwA	
1	Inlet	36	42	54	55	56	55	54	47	62
	Outlet	36	46	52	47	52	50	47	39	58
	Break-Out	36	38	46	40	42	44	43	38	51
2	Inlet	34	40	54	53	54	52	49	44	60
	Outlet	31	41	51	43	48	47	43	36	55
	Break-Out	35	37	47	39	41	42	40	35	50
3	Inlet	31	41	55	55	56	52	49	43	61
	Outlet	31	42	48	43	48	47	43	37	54
	Break-Out	31	38	47	41	43	41	39	34	51
4	Inlet	33	41	51	52	54	52	49	43	59
	Outlet	31	42	47	43	48	45	41	33	53
	Break-Out	33	38	42	37	40	41	40	36	48
5	Inlet	31	40	50	50	51	50	47	40	57
	Outlet	28	41	48	41	46	44	38	31	52
	Break-Out	30	37	41	36	38	39	37	34	46
6	Inlet	28	39	50	49	51	48	44	38	56
	Outlet	26	39	46	40	45	43	38	32	51
	Break-Out	28	36	41	35	37	37	35	31	45
7	Inlet	29	38	44	46	48	46	42	34	53
	Outlet	28	39	44	40	43	40	34	27	49
	Break-Out	30	35	39	34	36	38	33	29	44
8	Inlet	25	37	43	45	46	44	38	31	51
	Outlet	24	38	42	39	40	37	31	26	47
	Break-Out	26	34	38	32	34	35	30	26	42
9	Inlet	25	37	44	45	46	42	36	29	51
	Outlet	24	39	43	38	40	37	30	26	47
	Break-Out	25	34	39	32	34	33	28	24	42

PERFORMANCE CURVES

- q_v : Airflow in m^3/h .
- p_{sf} : Static pressure in Pa.
- SFP: Specific fan power in $W/m^3/s$ (blue curves).
- Dry air at 20°C and 760 mmHg.
- Performance data in accordance with ISO 5801 and AMCA 210-99 Standards.

CAB-160 B

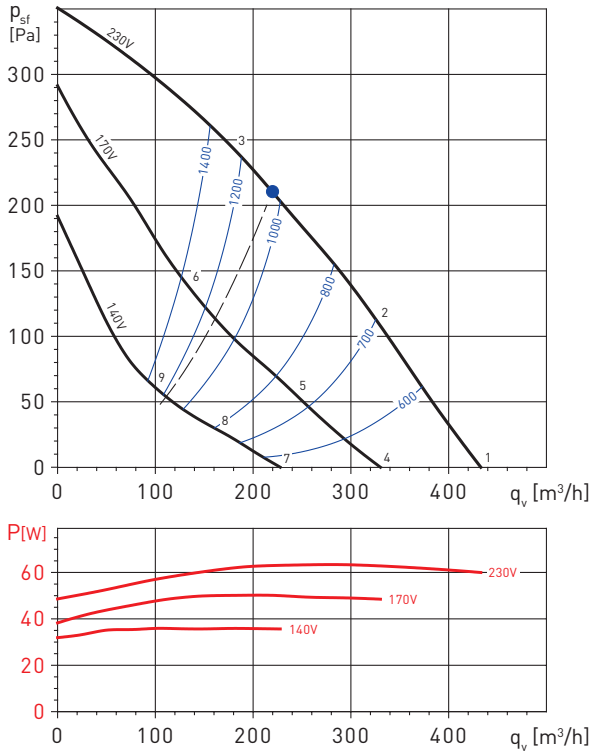

CAB-200 B

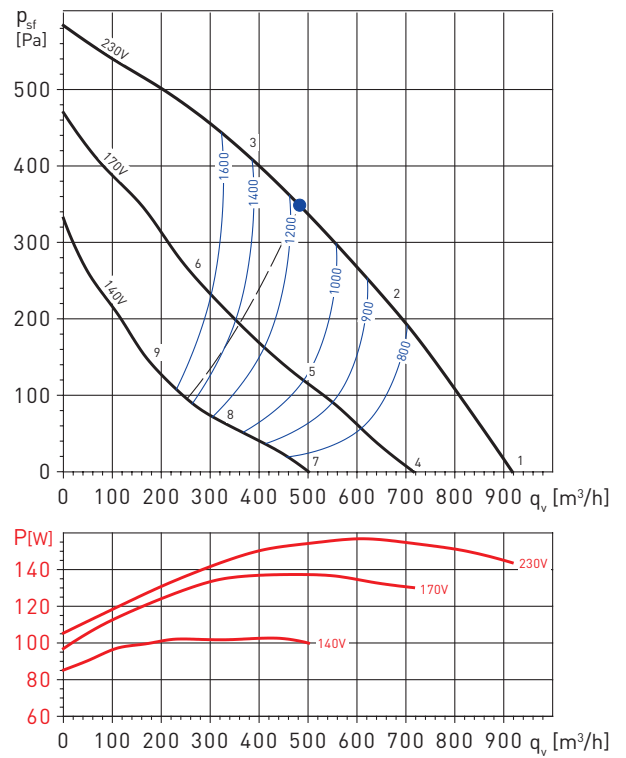

Sound power level spectrums in dB(A)

Working point		63	125	250	500	1.000	2.000	4.000	8.000	LwA
1	Inlet	36	42	54	55	56	55	54	47	62
	Outlet	36	46	52	47	52	50	47	39	58
	Break-Out	36	38	46	40	42	44	43	38	51
2	Inlet	34	40	54	53	54	52	49	44	60
	Outlet	31	41	51	43	48	47	43	36	55
	Break-Out	35	37	47	39	41	42	40	35	50
3	Inlet	31	41	55	55	56	52	49	43	61
	Outlet	31	42	48	43	48	47	43	37	54
	Break-Out	31	38	47	41	43	41	39	34	51
4	Inlet	33	41	51	52	54	52	49	43	59
	Outlet	31	42	47	43	48	45	41	33	53
	Break-Out	33	38	42	37	40	41	40	36	48
5	Inlet	31	40	50	50	51	50	47	40	57
	Outlet	28	41	48	41	46	44	38	31	52
	Break-Out	30	37	41	36	38	39	37	34	46
6	Inlet	28	39	50	49	51	48	44	38	56
	Outlet	26	39	46	40	45	43	38	32	51
	Break-Out	28	36	41	35	37	37	35	31	45
7	Inlet	29	38	44	46	48	46	42	34	53
	Outlet	28	39	44	40	43	40	34	27	49
	Break-Out	30	35	39	34	36	38	33	29	44
8	Inlet	25	37	43	45	46	44	38	31	51
	Outlet	24	38	42	39	40	37	31	26	47
	Break-Out	26	34	38	32	34	35	30	26	42
9	Inlet	25	37	44	45	46	42	36	29	51
	Outlet	24	39	43	38	40	37	30	26	47
	Break-Out	25	34	39	32	34	33	28	24	42

Sound power level spectrums in dB(A)

Working point		63	125	250	500	1.000	2.000	4.000	8.000	LwA
1	Inlet	42	48	63	65	67	60	60	56	71
	Outlet	46	52	56	53	58	58	55	48	64
	Break-Out	41	42	53	45	46	43	44	41	55
2	Inlet	37	47	62	62	62	56	58	54	68
	Outlet	39	48	54	50	56	56	53	48	62
	Break-Out	38	42	53	43	43	41	43	40	55
3	Inlet	34	48	63	63	63	58	59	54	69
	Outlet	38	47	54	50	54	57	54	49	62
	Break-Out	33	41	52	42	42	40	42	39	54
4	Inlet	37	48	59	61	63	56	56	51	67
	Outlet	42	51	53	50	55	55	51	44	61
	Break-Out	37	42	47	41	43	40	40	39	51
5	Inlet	34	47	58	58	59	53	53	48	64
	Outlet	34	49	51	46	52	51	48	41	58
	Break-Out	33	41	46	38	39	36	37	36	49
6	Inlet	31	47	57	57	57	52	53	48	63
	Outlet	33	48	51	46	51	52	48	42	58
	Break-Out	32	42	46	38	38	37	38	35	49
7	Inlet	33	45	54	56	57	52	50	44	62
	Outlet	37	48	49	46	50	51	46	38	57
	Break-Out	33	40	44	39	40	37	37	32	48
8	Inlet	29	44	52	54	54	48	47	40	59
	Outlet	32	47	46	43	47	47	42	34	54
	Break-Out	29	38	42	36	36	33	33	28	45
9	Inlet	26	44	50	51	51	46	44	38	57
	Outlet	31	46	46	43	46	46	39	33	53
	Break-Out	26	38	41	34	34	31	30	26	44

PERFORMANCE CURVES

- q_v : Airflow in m^3/h .
- p_{sf} : Static pressure in Pa.
- SFP: Specific fan power in $W/m^3/s$ (blue curves).
- Dry air at $20^\circ C$ and 760 mmHg.
- Performance data in accordance with ISO 5801 and AMCA 210-99 Standards.

CAB-250 B

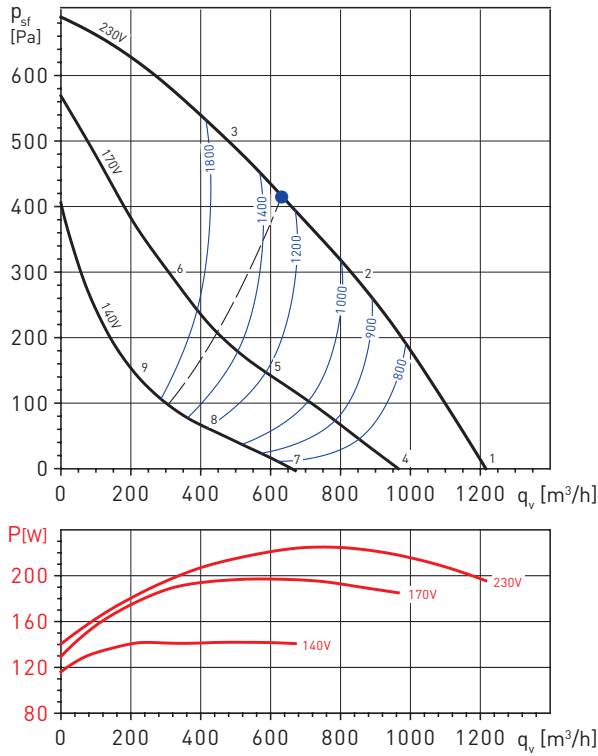

Sound power level spectrums in dB(A)

Working point		63	125	250	500	1.000	2.000	4.000	8.000	LwA
1	Inlet	43	51	66	68	70	62	62	58	74
	Outlet	51	55	58	56	60	62	59	52	67
	Break-Out	43	44	55	47	48	44	45	43	58
2	Inlet	38	50	65	65	65	58	61	57	71
	Outlet	42	51	55	52	58	59	56	51	64
	Break-Out	39	44	55	46	44	41	44	43	57
3	Inlet	36	51	67	66	66	60	63	58	72
	Outlet	41	49	57	53	57	61	58	53	65
	Break-Out	35	43	54	44	42	41	44	41	56
4	Inlet	40	51	63	65	67	59	59	56	71
	Outlet	46	54	55	52	57	59	55	48	64
	Break-Out	40	44	50	44	45	41	41	41	54
5	Inlet	34	49	60	60	61	53	55	51	66
	Outlet	38	53	52	49	54	55	52	45	61
	Break-Out	34	42	48	39	39	35	37	36	50
6	Inlet	33	51	60	60	60	54	56	52	66
	Outlet	36	52	53	48	54	55	52	47	61
	Break-Out	33	43	47	38	38	36	39	37	50
7	Inlet	34	48	57	60	61	53	53	48	65
	Outlet	39	51	50	47	52	54	50	41	59
	Break-Out	34	41	46	41	41	37	38	33	50
8	Inlet	30	46	54	56	56	49	49	43	61
	Outlet	35	50	48	45	49	51	47	38	57
	Break-Out	30	39	43	37	36	33	34	28	46
9	Inlet	26	47	53	53	53	47	47	41	59
	Outlet	34	50	48	45	48	50	43	36	56
	Break-Out	26	39	41	34	33	30	31	26	44

MOUNTING ACCESSORIES



MBE
 Electric heaters.



MFL-G4
 Filtration boxes.



ACOPEL F400 N
 Circular flexible connector.



KSE-45
 Flexible supports
 Rubber anti-vibration
 mounts to reduce
 vibration and noise
 transmission to the
 installation.
 [1KSE = set of 4
 supports per bag].

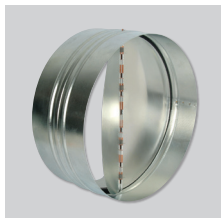

CAR
 Circular back
 draft shutters.



APC
 Discharge protection
 guards for direct
 connection to the
 inlet-outlet flange.
 (please see
 pages Mounting
 Accessories).

ELECTRICAL ACCESSORIES



REB
 Electronic single
 phase speed
 controllers.



RMB
 Autotransformer
 single phase speed
 controllers.



**PARO/MARCA 5P
 and 8P**
 ON/OFF electrical
 isolation switch.



PULSER
 Electric heater
 controllers for
 1Ph models up
 to 3600W and
 3Ph models up to
 6400W.



TTC 2000
 Electric heater
 controllers for
 3 phase models.



TG-K
 Duct temperature
 sensor.



TG-R
 Room wall mounted
 temperature sensor.

For more information see Electrical accessories.