



Range of direct drive backward curved centrifugal cabinet fans designed for ventilation of commercial kitchens and industrial applications. Cabinet fan manufactured from aluminium profiles and double thickness side panels internally lined with 25 mm thickness of fireproof fiberglass acoustic insulation. Circular duct connection flange on the inlet and outlet. CVAB-N/CVAT-N incorporates direct drive backward curved centrifugal impeller, manufactured from aluminium (CVAB-N) or steel (CVAT-N) sheet, with motor fitted inside the air stream.

Motors

CVAB-N
Single-phase external rotor motors 230V 50Hz, IP55, class F, with thermal protection, speed controllable by tension. Working temperature from -40°C to 60°C.

CVAT-N
Three-phase 4 and 6 pole motors 230/400V 50Hz, IP55, class F, with thermal protection (PTC), speed controllable by inverter. Working temperature from -20°C to 40°C.

ATEX versions

On request, explosion proof versions in accordance to ATEX Directive, for three phase models. Working temperature from -20°C to +40°C.

- ATEX Flameproof - Gas

In standard ATEX version flameproof motors are without thermal protection.

If used with frequency inverter, flameproof motors with a PTC-type thermal protection must be specified at order.

⊕ II 2G Exd IIB T4

⊕ II 2G Exd IIB+H2 T4 (with motor Exd IIC T4)

- ATEX Increased safety - Gas

⊕ II 2G Exe IIC T3

To select CVAT-N ATEX refer to performance curves, or Easyvent. Note electrical data may vary for ATEX motors.

Specific applications



Versions



Backward curved centrifugal impellers

To prevent accumulation of dirtiness. Dynamically balanced.

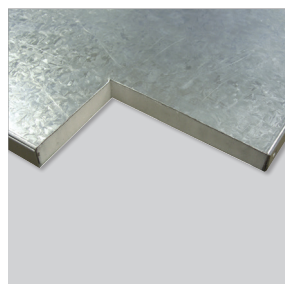

Low noise level

Double thickness side panels lined with 25 mm thickness of fireproof fiberglass acoustic insulation.



Robustness

Quality finished aluminium profiles and plastic corners providing a great robustness.



IP55 external terminal box

To ease electrical connection. Only available for CVAB single-phase models. For three-phase models, connection to the motor terminal box.

Alternative fitting

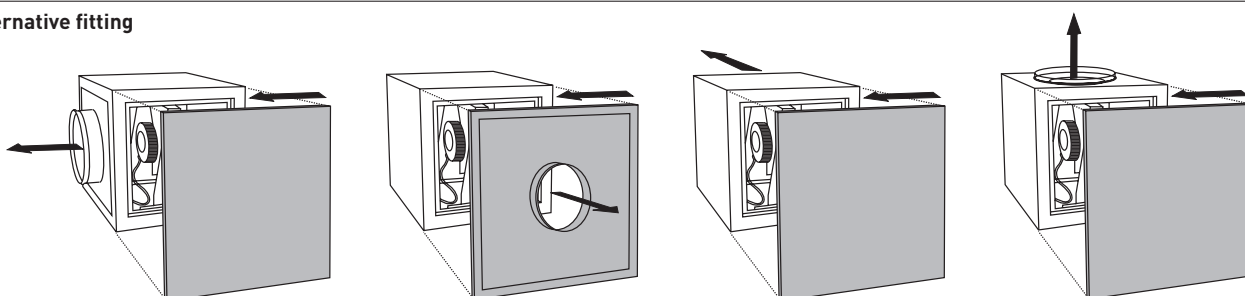

TECHNICAL CHARACTERISTICS

Before installation check that the product electrical characteristics listed on the data plate label (voltage, power, frequency, etc.) match those of the intended electrical supply.

Model	Speed (rpm)	Maximum absorbed power (W)	Maximum absorbed current (A)	Maximum airflow (m³/h)	Sound pressure level* (dB(A))			Weight (kg)	Speed control	
					Inlet	Radiated	Outlet		REB	RMB
SINGLE-PHASE 4 POLES										
CVAB/4-1400/250N D	1300	107	0,5	1280	49	44	50	13,0	REB-1	RMB-1,5
CVAB/4-2000/315N D	1390	169	0,7	1820	53	47	54	13,0	REB-1	RMB-1,5
CVAB/4-3000/355N D	1370	312	1,3	2800	58	51	58	30,0	REB-2,5	RMB-1,5
CVAB/4-4000/400N D	1390	557	2,3	4210	62	54	60	32,0	REB-2,5	RMB-3,5
CVAB/4-6000/450N D	1380	930	4,0	6140	64	57	63	46,0	REB-5	RMB-5
CVAB/4-9000/500N D	1390	1289	5,5	7580	68	61	66	58,0	REB-10	RMB-8

Model	Speed (rpm)	Maximum absorbed power (W)	Maximum absorbed current (A)		Maximum airflow (m³/h)	Sound pressure level* (dB(A))			Weight (kg)	
			230V	400V		Inlet	Radiated	Outlet		
THREE-PHASE 4 POLES										
CVAT/4-1400/250N D 0,18	1480	116	0,9	0,5	1.230	50	37	48	13,0	
CVAT/4-2000/315N D 0,18	1460	169	0,9	0,5	1.830	54	41	53	13,0	
CVAT/4-3000/355N D 0,18	1430	251	0,9	0,5	2.660	56	43	56	30,0	
CVAT/4-4000/400N D 0,37	1445	438	1,6	0,9	3.850	60	47	60	32,0	
CVAT/4-6000/450N D 0,75	1465	747	3,0	1,7	5.620	63	50	64	46,0	
CVAT/4-9000/500N D 1,1	1480	1347	4,4	2,5	7.900	67	53	68	58,0	
CVAT/4-12000/560N D 2,2	1470	2093	7,3	4,2	11.100	69	56	71	82,0	
CVAT/4-16000/630N D 3	1460	3234	10,3	5,9	14.640	72	60	75	113,0	

THREE-PHASE 6 POLES										
CVAT/6-15000/710N D 1,5	970	1828	6,3	3,6	14.320	72	60	74	149,0	

* Sound pressure level measured in free field condition at 1.5m, at the medium working point on the performance curve, shown 2, 5, 8 and 11.

Model	VFTM		VFKB	
	1-PHASE SUPPLY	3-PHASE SUPPLY	1-PHASE SUPPLY	3-PHASE SUPPLY
CVAT/4-1400/250N D 0,18	VFTM MONO 0,18	VFTM TRI 0,37	VFKB-24	VFKB-45
CVAT/4-2000/315N D 0,18	VFTM MONO 0,18	VFTM TRI 0,37	VFKB-24	VFKB-45
CVAT/4-3000/355N D 0,18	VFTM MONO 0,18	VFTM TRI 0,37	VFKB-24	VFKB-45
CVAT/4-4000/400N D 0,37	VFTM MONO 0,37	VFTM TRI 0,37	VFKB-24	VFKB-45
CVAT/4-6000/450N D 0,75	VFTM MONO 0,37	VFTM TRI 0,75	VFKB-24	VFKB-45
CVAT/4-9000/500N D 1,1	VFTM MONO 0,75	VFTM TRI 1,1	VFKB-24	VFKB-45
CVAT/4-12000/560N D 2,2	VFTM MONO 1,5	VFTM TRI 2,2	VFKB-27	VFKB-48
CVAT/4-16000/630N D 3	VFTM MONO 2,2	VFTM TRI 3	VFKB-27	VFKB-48
CVAT/6-15000/710N D 1,5	VFTM MONO 1,1	VFTM TRI 1,5	VFKB-27	VFKB-48

DIMENSIONS (mm)

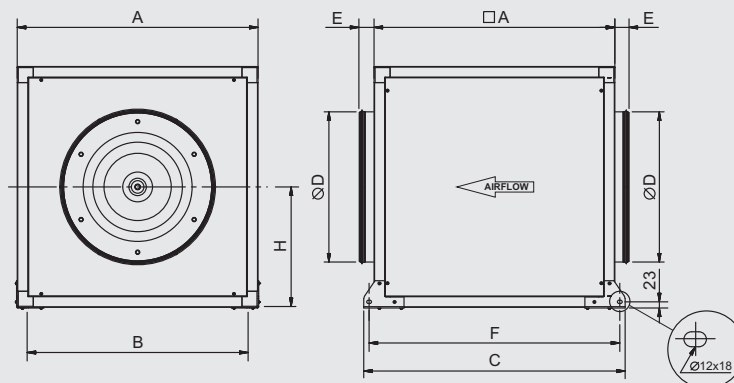

Model CVAB - CVAT	A	B	C	D	E	F	H
1400/250N D	500	457	574	250	58	534	250
2000/315N D	500	457	574	315	58	534	250
3000/355N D	650	607	724	355	58	684	325
4000/400N D	650	607	724	400	58	684	325
6000/450N D	750	707	824	450	58	784	375
9000/500N D	800	757	874	500	58	834	400
12000/560N D	900	826	977	560	58	937	450
16000/630N D	1000	959	1077	630	58	1037	500
15000/710N D	1100	1059	1177	710	58	1137	550

PERFORMANCE CURVES - ACOUSTIC CHARACTERISTICS

- q_v : Airflow in m^3/h .
- p_{sf} : Static pressure in Pa.
- P: Input power in W.
- SFP: Specific fan power in $W/m^3/s$ (blue curves).
- Performance data in accordance with ISO 5801 and AMCA 210-99 Standards.

CVAB/4-1400/250N D

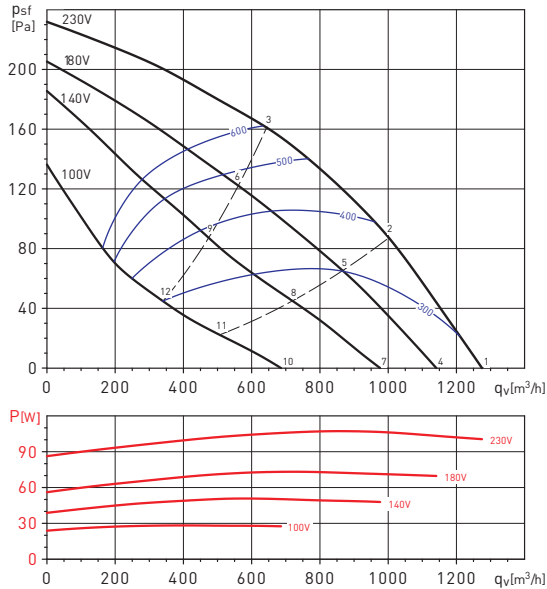

CVAB/4-2000/315N D

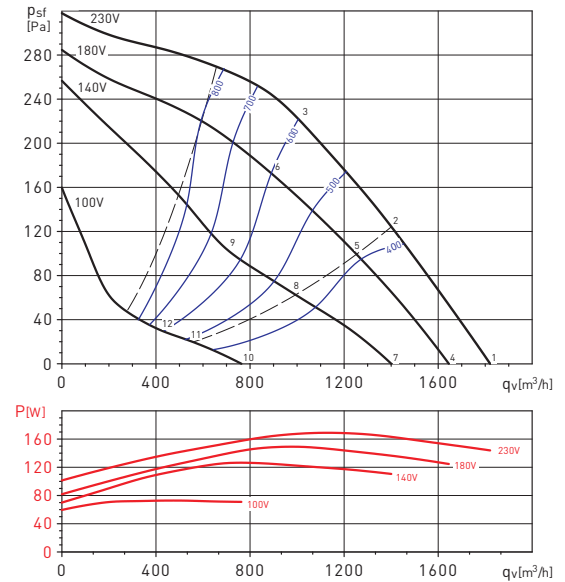

Working point	63	125	250	500	1000	2000	4000	8000	LwA	
1	Inlet	32	50	58	59	61	57	56	37	66
	Outlet	35	49	57	59	60	56	49	35	65
	Break-Out	26	43	46	49	55	56	51	28	60
2	Inlet	28	48	56	57	59	57	53	36	64
	Outlet	29	47	55	57	61	58	47	35	64
3	Inlet	26	47	53	56	60	58	44	52	64
	Outlet	27	44	52	57	62	61	51	41	66
4	Inlet	21	41	42	47	54	57	47	35	60
	Outlet	32	32	57	57	59	57	56	35	64
5	Inlet	33	31	55	57	55	58	48	32	63
	Break-Out	26	28	42	47	54	56	51	27	60
6	Inlet	26	30	54	55	57	56	49	33	62
	Outlet	27	30	52	55	55	58	44	31	62
7	Inlet	21	25	39	46	53	55	45	25	58
	Break-Out	26	29	53	55	58	56	48	38	62
8	Inlet	26	31	50	55	60	60	46	38	64
	Break-Out	20	25	38	46	54	55	44	31	58
9	Inlet	30	44	55	55	56	56	48	31	62
	Outlet	30	44	53	54	56	53	43	31	61
10	Inlet	23	38	40	45	51	54	42	22	56
	Break-Out	25	41	54	53	55	55	39	31	60
11	Inlet	25	40	50	53	57	52	36	29	60
	Break-Out	18	35	39	43	50	53	33	21	55
12	Inlet	23	37	49	51	54	50	41	33	58
	Outlet	24	39	48	52	58	54	41	32	60
13	Inlet	17	31	34	41	49	48	35	24	52
	Break-Out	27	35	48	49	52	49	33	26	56
14	Inlet	28	39	47	50	51	48	32	26	55
	Break-Out	22	30	34	50	47	42	26	17	52
15	Inlet	23	34	45	48	50	41	30	26	53
	Outlet	26	36	43	47	49	39	28	25	52
16	Inlet	18	29	31	41	48	38	23	17	49
	Break-Out	23	34	43	47	47	36	28	32	51
17	Inlet	23	35	40	45	50	38	30	27	52
	Break-Out	17	29	30	40	45	34	25	19	47

Working point	63	125	250	500	1000	2000	4000	8000	LwA	
1	Inlet	37	55	63	64	65	62	60	45	70
	Outlet	40	55	61	64	65	60	54	42	69
	Break-Out	32	50	52	55	58	58	53	35	63
2	Inlet	32	53	60	62	63	60	56	42	68
	Outlet	35	52	59	61	65	61	51	40	68
3	Inlet	27	48	50	53	57	57	49	33	61
	Break-Out	32	52	58	61	63	61	47	55	67
4	Inlet	26	46	47	51	57	57	49	38	61
	Outlet	37	37	62	63	63	62	59	43	69
5	Inlet	39	35	60	62	59	64	53	40	68
	Break-Out	32	31	49	53	58	58	53	34	62
6	Inlet	31	34	59	60	61	59	53	40	66
	Outlet	33	33	57	59	58	62	48	37	66
7	Inlet	26	29	46	51	55	56	47	31	60
	Break-Out	31	33	56	58	60	58	52	42	65
8	Inlet	31	33	54	58	60	62	49	41	66
	Break-Out	25	27	43	49	55	55	46	35	59
9	Inlet	35	50	59	60	60	60	53	39	66
	Outlet	36	50	57	59	60	57	48	37	65
10	Inlet	30	45	46	50	55	56	47	29	60
	Break-Out	29	46	56	56	57	56	44	35	63
11	Inlet	30	45	53	55	59	54	41	32	62
	Outlet	24	41	43	47	52	53	38	25	56
12	Inlet	27	41	51	53	55	52	44	36	59
	Break-Out	28	44	49	53	58	54	42	34	61
13	Inlet	22	36	38	43	50	48	37	27	53
	Outlet	29	40	49	51	53	51	36	29	57
14	Inlet	30	42	47	50	52	48	34	28	56
	Break-Out	26	35	38	50	48	45	30	21	53
15	Inlet	24	38	46	48	49	43	32	27	53
	Outlet	27	39	44	47	50	41	31	26	53
16	Inlet	21	34	35	42	47	40	26	20	49
	Break-Out	22	36	43	45	46	38	28	33	50
17	Inlet	24	37	41	45	50	40	31	27	52
	Break-Out	19	31	31	39	43	35	26	20	45

PERFORMANCE CURVES - ACOUSTIC CHARACTERISTICS

- q_v : Airflow in m^3/h .
- p_{st} : Static pressure in Pa.
- P: Input power in W.
- SFP: Specific fan power in $W/m^3/s$ (blue curves).
- Performance data in accordance with ISO 5801 and AMCA 210-99 Standards.

CVAB/4-3000/355N D

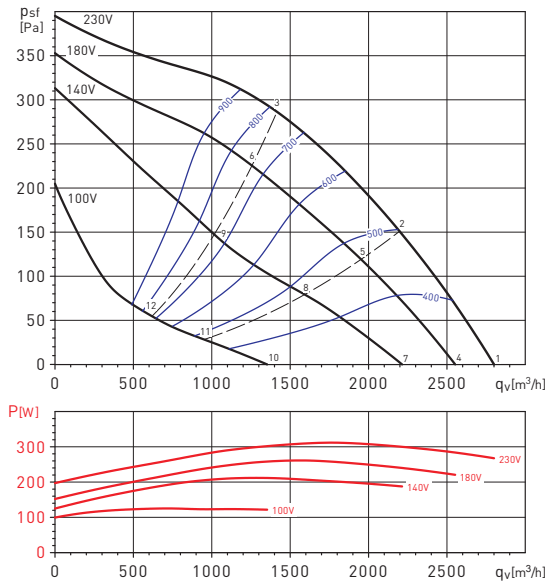

CVAB/4-4000/400N D

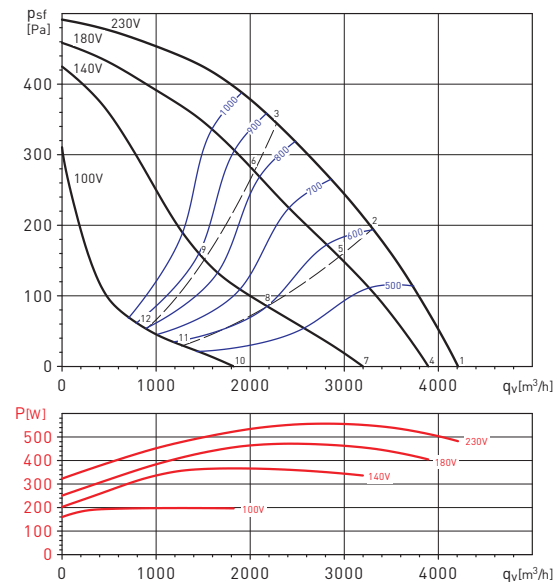

Working point		63	125	250	500	1000	2000	4000	8000	LwA
1	Inlet	32	50	58	59	61	57	56	37	66
	Outlet	35	49	57	59	60	56	49	35	65
	Break-Out	26	43	46	49	55	56	51	28	60
2	Inlet	28	48	56	57	59	57	53	36	64
	Outlet	29	47	55	57	61	58	47	35	64
	Break-Out	22	41	44	48	54	56	48	27	59
3	Inlet	26	47	53	56	60	58	44	52	64
	Outlet	27	44	52	57	62	61	51	41	66
	Break-Out	21	41	42	47	54	57	47	35	60
4	Inlet	32	32	57	57	59	57	56	35	64
	Outlet	33	31	55	57	55	58	48	32	63
	Break-Out	26	28	42	47	54	56	51	27	60
5	Inlet	26	30	54	55	57	56	49	33	62
	Outlet	27	30	52	55	55	58	44	31	62
	Break-Out	21	25	39	46	53	55	45	25	58
6	Inlet	26	29	53	55	58	56	48	38	62
	Outlet	26	31	50	55	60	60	46	38	64
	Break-Out	20	25	38	46	54	55	44	31	58
7	Inlet	30	44	55	55	56	56	48	31	62
	Outlet	30	44	53	54	56	53	43	31	61
	Break-Out	23	38	40	45	51	54	42	22	56
8	Inlet	25	41	54	53	55	55	39	31	60
	Outlet	25	40	50	53	57	52	36	29	60
	Break-Out	18	35	39	43	50	53	33	21	55
9	Inlet	23	37	49	51	54	50	41	33	58
	Outlet	24	39	48	52	58	54	41	32	60
	Break-Out	17	31	34	41	49	48	35	24	52
10	Inlet	27	35	48	49	52	49	33	26	56
	Outlet	28	39	47	50	51	48	32	26	55
	Break-Out	22	30	34	50	47	42	26	17	52
11	Inlet	23	34	45	48	50	41	30	26	53
	Outlet	26	36	43	47	49	39	28	25	52
	Break-Out	18	29	31	41	48	38	23	17	49
12	Inlet	23	34	43	47	47	36	28	32	51
	Outlet	23	35	40	45	50	38	30	27	52
	Break-Out	17	29	30	40	45	34	25	19	47

Working point		63	125	250	500	1000	2000	4000	8000	LwA
1	Inlet	37	55	63	64	65	62	60	45	70
	Outlet	40	55	61	64	65	60	54	42	69
	Break-Out	32	50	52	55	58	58	53	35	63
2	Inlet	32	53	60	62	63	60	56	42	68
	Outlet	35	52	59	61	65	61	51	40	68
	Break-Out	27	48	50	53	57	57	49	33	61
3	Inlet	32	52	58	61	63	61	47	55	67
	Outlet	32	49	56	60	64	62	53	44	68
	Break-Out	26	46	47	51	57	57	49	38	61
4	Inlet	37	37	62	63	63	62	59	43	69
	Outlet	39	35	60	62	59	64	53	40	68
	Break-Out	32	31	49	53	58	58	53	34	62
5	Inlet	31	34	59	60	61	59	53	40	66
	Outlet	33	33	57	59	58	62	48	37	66
	Break-Out	26	29	46	51	55	56	47	31	60
6	Inlet	31	33	56	58	60	58	52	42	65
	Outlet	31	33	54	58	60	62	49	41	66
	Break-Out	25	27	43	49	55	55	46	35	59
7	Inlet	35	50	59	60	60	60	53	39	66
	Outlet	36	50	57	59	60	57	48	37	65
	Break-Out	30	45	46	50	55	56	47	29	60
8	Inlet	29	46	56	56	57	56	44	35	63
	Outlet	30	45	53	55	59	54	41	32	62
	Break-Out	24	41	43	47	52	53	38	25	56
9	Inlet	27	41	51	53	55	52	44	36	59
	Outlet	28	44	49	53	58	54	42	34	61
	Break-Out	22	36	38	43	50	48	37	27	53
10	Inlet	29	40	49	51	53	51	36	29	57
	Outlet	30	42	47	50	52	48	34	28	56
	Break-Out	26	35	38	50	48	45	30	21	53
11	Inlet	24	38	46	48	49	43	32	27	53
	Outlet	27	39	44	47	50	41	31	26	53
	Break-Out	21	34	35	42	47	40	26	20	49
12	Inlet	22	36	43	45	46	38	28	33	50
	Outlet	24	37	41	45	50	40	31	27	52
	Break-Out	19	31	31	39	43	35	26	20	45

PERFORMANCE CURVES - ACOUSTIC CHARACTERISTICS

- q_v : Airflow in m^3/h .
- p_{sf} : Static pressure in Pa.
- P: Input power in W.
- SFP: Specific fan power in $W/m^3/s$ (blue curves).
- Performance data in accordance with ISO 5801 and AMCA 210-99 Standards.

CVAB/4-6000/450N D

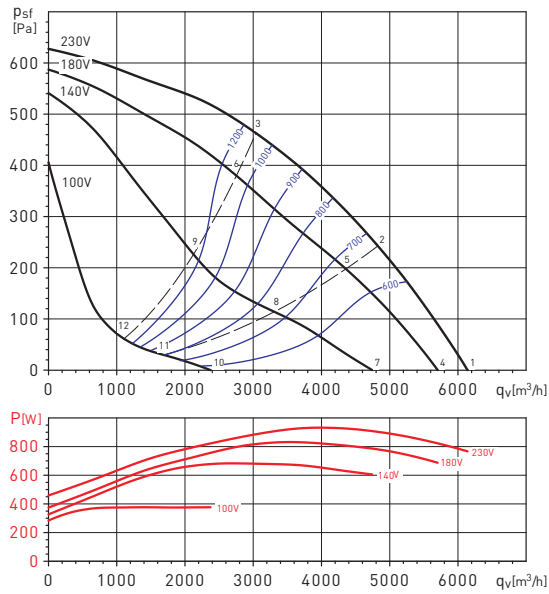

CVAB/4-9000/500N D

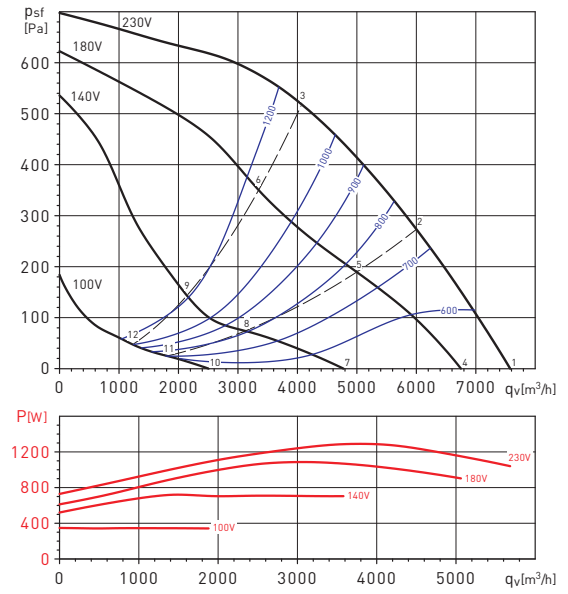

Working point	63	125	250	500	1000	2000	4000	8000	LwA
1	Inlet	41	60	66	68	67	65	62	73
	Outlet	45	59	65	67	68	63	57	73
	Break-Out	36	55	57	59	61	59	54	66
2	Inlet	38	60	66	67	67	64	59	73
	Outlet	40	58	63	66	69	64	55	72
	Break-Out	33	55	57	58	60	58	52	65
3	Inlet	38	58	63	66	67	64	52	72
	Outlet	38	54	60	64	67	64	56	71
	Break-Out	33	53	54	56	60	58	51	64
4	Inlet	40	40	65	67	66	64	61	72
	Outlet	43	38	63	65	62	67	56	71
	Break-Out	35	34	55	57	59	58	53	64
5	Inlet	37	38	63	65	65	63	57	70
	Outlet	39	37	61	63	61	66	52	69
	Break-Out	32	32	53	55	58	56	49	62
6	Inlet	36	36	60	62	63	61	55	68
	Outlet	36	36	58	61	61	64	53	68
	Break-Out	31	30	49	53	57	55	48	61
7	Inlet	38	55	62	63	62	61	57	69
	Outlet	41	54	60	61	63	59	52	68
	Break-Out	35	49	52	54	57	56	50	62
8	Inlet	33	52	58	59	59	58	50	65
	Outlet	35	51	56	58	61	56	46	64
	Break-Out	30	46	48	50	53	52	43	58
9	Inlet	31	47	53	55	57	54	48	62
	Outlet	32	49	51	55	59	55	45	62
	Break-Out	27	41	43	47	51	48	41	55
10	Inlet	31	45	51	53	53	53	40	59
	Outlet	33	46	48	50	54	48	37	57
	Break-Out	29	40	41	49	47	46	32	53
11	Inlet	26	43	48	50	50	47	36	56
	Outlet	29	44	46	48	52	44	35	55
	Break-Out	24	38	38	43	45	41	28	49
12	Inlet	24	41	45	47	47	43	31	52
	Outlet	26	42	44	47	51	44	34	54
	Break-Out	23	36	35	40	43	37	28	46

Working point	63	125	250	500	1000	2000	4000	8000	LwA
1	Inlet	46	65	71	73	71	69	66	78
	Outlet	50	65	69	71	73	68	62	77
	Break-Out	42	61	63	64	64	61	57	70
2	Inlet	42	65	69	71	70	67	61	76
	Outlet	45	62	66	69	71	65	58	75
	Break-Out	37	60	62	62	63	58	52	68
3	Inlet	43	63	68	70	70	67	56	76
	Outlet	43	59	64	67	70	65	59	73
	Break-Out	39	58	60	61	63	59	53	68
4	Inlet	45	45	71	73	70	69	65	77
	Outlet	50	44	69	70	67	73	61	76
	Break-Out	41	38	62	63	63	60	56	68
5	Inlet	41	41	67	69	67	65	60	74
	Outlet	43	40	64	66	63	69	55	72
	Break-Out	36	34	58	59	59	56	50	65
6	Inlet	41	39	64	66	66	64	59	72
	Outlet	42	39	61	63	62	67	56	70
	Break-Out	36	32	55	56	59	54	49	63
7	Inlet	43	61	66	68	66	65	62	73
	Outlet	47	60	63	65	67	62	57	72
	Break-Out	41	55	58	60	60	57	54	66
8	Inlet	36	55	59	61	59	58	54	66
	Outlet	38	55	57	59	61	56	48	65
	Break-Out	34	50	51	52	53	50	46	59
9	Inlet	34	51	55	57	58	56	51	63
	Outlet	36	53	52	56	59	55	47	63
	Break-Out	32	46	48	49	52	48	44	56
10	Inlet	33	50	53	56	54	56	44	61
	Outlet	36	50	50	51	56	49	40	59
	Break-Out	33	45	45	49	48	49	36	54
11	Inlet	26	46	48	50	49	49	38	56
	Outlet	30	47	47	48	52	45	36	55
	Break-Out	25	41	40	43	43	41	30	49
12	Inlet	25	45	45	47	47	47	33	53
	Outlet	28	45	45	48	52	46	37	55
	Break-Out	25	40	37	40	41	39	30	47

PERFORMANCE CURVES - ACOUSTIC CHARACTERISTICS

- q_v : Airflow in m^3/h .
- p_{st} : Static pressure in Pa.
- P: Input power in W.
- SFP: Specific fan power in $W/m^3/s$ (blue curves).
- Performance data in accordance with ISO 5801 and AMCA 210-99 Standards.

CVAT/4-1400/250N D 0,18kW

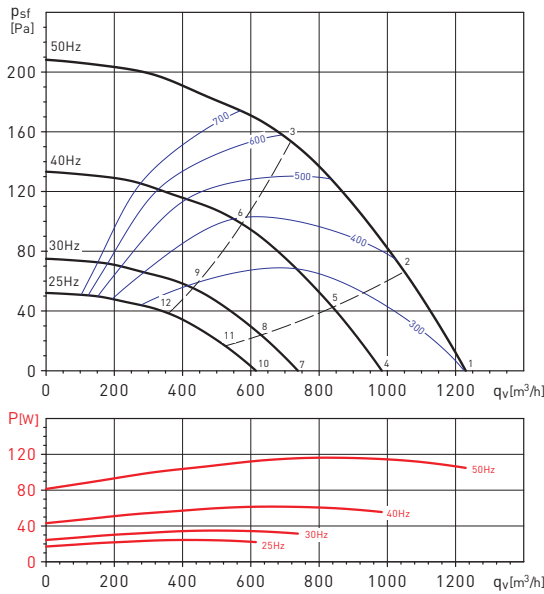

CVAT/4-2000/315N D 0,18kW

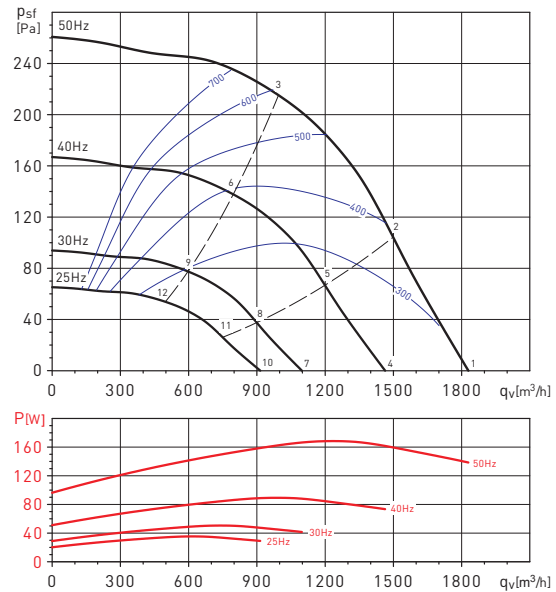

Working point	63	125	250	500	1000	2000	4000	8000	LwA	
1	Inlet	32	55	59	62	58	57	54	51	66
	Outlet	34	50	56	56	59	57	47	42	64
	Break-Out	28	44	45	48	47	45	36	30	53
2	Inlet	34	54	57	61	58	54	52	47	65
	Outlet	34	49	55	55	60	54	46	37	63
	Break-Out	29	42	43	47	47	42	34	24	52
3	Inlet	37	53	58	62	59	54	52	46	65
	Outlet	39	49	56	57	56	54	49	40	63
	Break-Out	31	41	43	48	48	44	35	25	53
4	Inlet	27	50	54	57	53	52	49	46	61
	Outlet	29	46	51	51	54	52	42	38	59
	Break-Out	23	39	40	43	43	40	31	25	48
5	Inlet	29	49	52	56	53	49	47	42	60
	Outlet	29	44	50	50	55	49	41	32	58
	Break-Out	24	38	38	42	42	37	30	19	47
6	Inlet	32	49	53	57	54	49	47	41	61
	Outlet	34	44	51	53	51	50	45	36	58
	Break-Out	26	37	38	43	43	39	30	20	48
7	Inlet	21	44	48	51	47	46	43	40	55
	Outlet	23	39	45	45	48	46	36	31	52
	Break-Out	17	33	33	37	36	34	25	18	42
8	Inlet	23	43	46	50	47	43	41	36	54
	Outlet	23	38	44	44	49	43	35	26	52
	Break-Out	18	31	32	36	35	31	23	13	41
9	Inlet	26	42	46	51	48	43	41	35	54
	Outlet	27	38	45	46	45	43	38	29	51
	Break-Out	20	30	31	37	37	33	24	14	41
10	Inlet	17	40	44	47	43	42	39	36	51
	Outlet	19	35	41	41	44	42	32	27	48
	Break-Out	13	29	30	33	32	30	21	15	38
11	Inlet	19	39	42	46	43	39	37	32	50
	Outlet	19	34	40	40	45	39	31	22	48
	Break-Out	14	27	28	32	32	27	19	9	37
12	Inlet	22	38	42	47	44	39	37	31	50
	Outlet	23	34	41	42	41	39	34	25	47
	Break-Out	16	26	27	33	33	29	20	10	38

Working point	63	125	250	500	1000	2000	4000	8000	LwA	
1	Inlet	37	60	63	66	63	62	58	54	71
	Outlet	40	56	61	61	64	62	52	47	69
	Break-Out	33	48	49	52	51	49	40	33	57
2	Inlet	38	59	62	64	62	58	56	51	69
	Outlet	39	54	60	59	64	58	50	41	67
	Break-Out	33	47	48	50	50	45	38	28	55
3	Inlet	40	57	61	64	61	57	55	49	68
	Outlet	42	53	59	61	59	57	52	43	66
	Break-Out	35	45	46	50	50	46	37	28	55
4	Inlet	32	55	58	61	58	58	53	50	66
	Outlet	35	51	56	56	59	57	47	42	64
	Break-Out	28	43	45	47	46	44	35	29	52
5	Inlet	33	54	57	60	57	53	51	46	64
	Outlet	34	49	55	54	59	53	46	37	63
	Break-Out	28	42	43	45	45	40	33	23	51
6	Inlet	35	52	56	59	57	52	50	44	63
	Outlet	37	49	54	56	54	52	47	39	61
	Break-Out	30	40	42	45	45	41	32	23	50
7	Inlet	26	49	52	55	51	51	47	43	59
	Outlet	29	45	50	50	53	50	41	36	57
	Break-Out	22	37	38	41	40	38	29	22	46
8	Inlet	27	48	51	53	50	47	45	40	58
	Outlet	28	43	49	48	53	47	39	30	56
	Break-Out	22	36	37	39	39	34	27	17	44
9	Inlet	29	46	50	53	50	46	44	38	57
	Outlet	31	42	48	50	48	46	41	32	55
	Break-Out	24	34	35	39	39	35	26	17	44
10	Inlet	22	45	48	51	47	47	43	39	56
	Outlet	25	41	46	46	49	47	37	32	54
	Break-Out	18	33	34	37	36	34	25	18	42
11	Inlet	23	44	47	49	47	43	41	36	54
	Outlet	24	39	45	44	49	43	35	26	52
	Break-Out	18	32	33	35	35	30	23	13	40
12	Inlet	25	42	46	49	46	42	40	34	53
	Outlet	27	38	44	46	44	42	37	28	51
	Break-Out	20	30	31	35	35	31	22	13	40

PERFORMANCE CURVES - ACOUSTIC CHARACTERISTICS

- q_v : Airflow in m^3/h .
- p_{st} : Static pressure in Pa.
- P: Input power in W.
- SFP: Specific fan power in $W/m^3/s$ (blue curves).
- Performance data in accordance with ISO 5801 and AMCA 210-99 Standards.

CVAT/4-3000/355N D 0,18kW

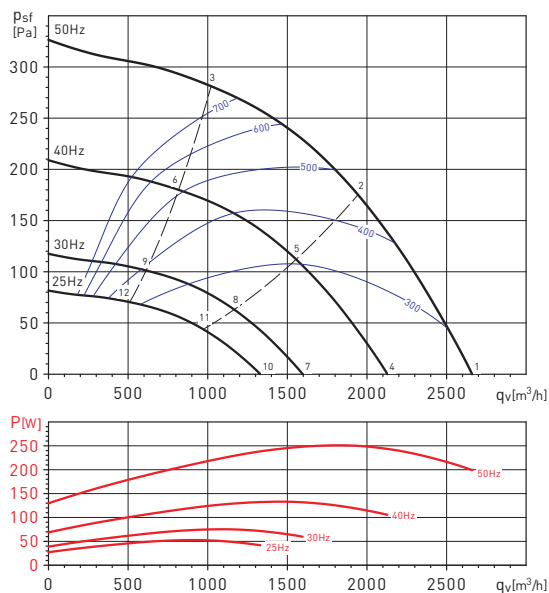

CVAT/4-4000/400N D 0,37kW

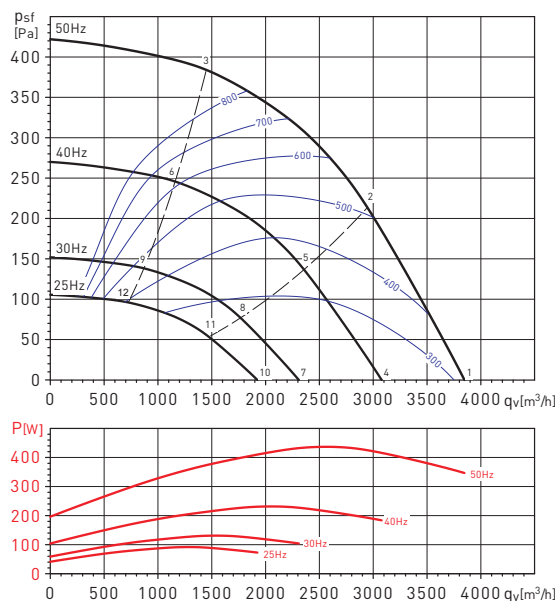

Working point		63	125	250	500	1000	2000	4000	8000	LwA
1	Inlet	41	64	67	69	66	67	61	57	74
	Outlet	45	61	65	66	68	66	57	50	73
	Break-Out	37	52	54	55	54	53	43	37	61
2	Inlet	40	61	64	66	64	61	57	52	71
	Outlet	42	58	63	62	67	60	53	44	70
	Break-Out	35	50	51	52	52	47	40	31	58
3	Inlet	41	58	61	63	61	57	55	49	68
	Outlet	43	55	59	61	59	57	51	44	66
	Break-Out	36	47	48	50	50	46	38	29	56
4	Inlet	37	59	62	64	61	62	56	53	69
	Outlet	40	56	61	61	63	61	52	45	68
	Break-Out	32	47	49	50	49	48	39	32	56
5	Inlet	35	57	59	61	59	56	53	48	66
	Outlet	38	53	58	57	62	55	48	39	65
	Break-Out	30	45	46	47	47	42	35	26	53
6	Inlet	36	53	56	58	56	53	50	44	63
	Outlet	38	50	54	56	54	52	47	39	61
	Break-Out	31	42	43	45	45	41	33	24	51
7	Inlet	30	53	56	58	55	56	50	46	63
	Outlet	34	50	54	55	57	55	46	39	62
	Break-Out	26	41	43	44	43	42	32	25	50
8	Inlet	29	50	53	55	53	50	46	41	60
	Outlet	31	47	52	51	56	49	42	33	59
	Break-Out	24	39	40	41	40	36	29	20	47
9	Inlet	30	47	50	52	50	46	43	38	57
	Outlet	32	44	48	50	48	46	40	32	55
	Break-Out	25	36	37	39	39	35	27	18	45
10	Inlet	26	49	52	54	51	52	46	42	59
	Outlet	30	46	50	51	53	51	42	35	58
	Break-Out	22	37	39	40	39	38	28	22	46
11	Inlet	25	46	49	51	49	46	42	37	56
	Outlet	27	43	48	47	52	45	38	29	55
	Break-Out	20	35	36	37	37	32	25	16	43
12	Inlet	26	43	46	48	46	42	39	34	53
	Outlet	28	40	44	46	44	42	36	28	51
	Break-Out	21	32	33	35	35	31	23	14	41

Working point		63	125	250	500	1000	2000	4000	8000	LwA
1	Inlet	45	67	70	71	68	70	64	59	77
	Outlet	50	65	68	69	71	69	60	52	76
	Break-Out	40	55	57	57	56	55	46	39	63
2	Inlet	43	65	68	69	67	65	61	56	74
	Outlet	47	63	68	66	71	64	57	49	74
	Break-Out	38	54	55	55	54	50	43	34	61
3	Inlet	44	62	65	66	64	61	57	52	71
	Outlet	47	59	62	65	62	60	54	47	69
	Break-Out	40	51	52	52	52	48	40	32	59
4	Inlet	40	62	65	66	64	65	59	55	72
	Outlet	45	61	64	65	66	64	55	48	71
	Break-Out	35	50	52	52	51	50	41	34	58
5	Inlet	38	61	63	64	62	60	56	51	70
	Outlet	42	58	63	61	66	59	52	44	69
	Break-Out	33	49	51	50	49	45	38	29	56
6	Inlet	39	57	60	61	59	56	52	47	66
	Outlet	42	54	57	60	57	55	49	42	64
	Break-Out	35	46	48	48	47	43	36	28	54
7	Inlet	33	56	59	60	57	59	53	48	66
	Outlet	39	54	57	58	60	58	49	41	65
	Break-Out	29	44	46	46	45	44	35	28	52
8	Inlet	32	54	57	58	56	54	49	44	63
	Outlet	36	52	57	55	60	53	46	37	63
	Break-Out	27	43	44	44	43	39	32	23	50
9	Inlet	33	51	53	55	53	50	46	41	60
	Outlet	36	48	51	54	51	49	43	36	58
	Break-Out	28	40	41	41	41	37	29	21	48
10	Inlet	29	52	55	56	53	55	49	44	62
	Outlet	35	50	53	54	56	54	45	37	61
	Break-Out	25	40	42	42	41	40	31	24	48
11	Inlet	28	50	53	54	52	50	46	41	59
	Outlet	32	48	53	51	56	49	42	34	59
	Break-Out	23	39	40	40	39	35	28	19	46
12	Inlet	29	47	50	51	49	46	42	37	56
	Outlet	32	44	47	50	47	45	39	32	54
	Break-Out	25	36	37	37	37	33	25	17	44

PERFORMANCE CURVES - ACOUSTIC CHARACTERISTICS

- q_v : Airflow in m^3/h .
- p_{st} : Static pressure in Pa.
- P: Input power in W.
- SFP: Specific fan power in $W/m^3/s$ (blue curves).
- Performance data in accordance with ISO 5801 and AMCA 210-99 Standards.

CVAT/4-6000/450N D 0,75kW

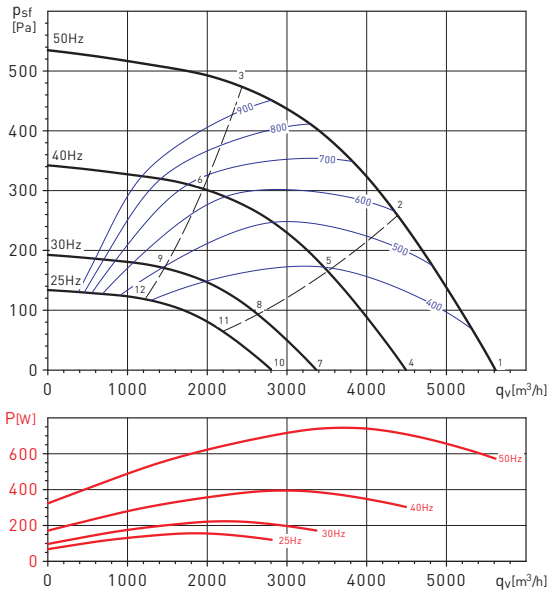

CVAT/4-9000/500N D 1,1kW

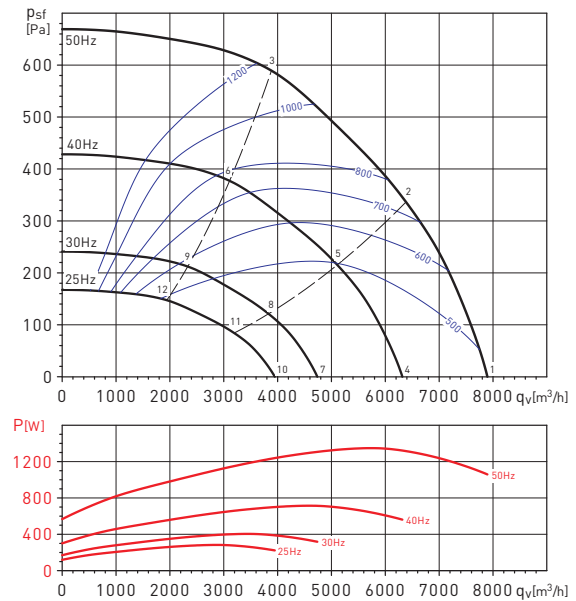

Working point	63	125	250	500	1000	2000	4000	8000	LwA	
1	Inlet	48	71	73	74	71	74	67	62	80
	Outlet	55	70	72	74	75	72	64	55	80
	Break-Out	43	59	61	59	58	58	49	41	66
2	Inlet	46	69	72	72	70	69	64	59	78
	Outlet	52	68	72	70	75	67	60	53	78
	Break-Out	41	58	60	58	57	53	46	38	65
3	Inlet	49	68	69	70	68	66	61	57	75
	Outlet	52	65	67	70	67	64	59	52	75
	Break-Out	44	57	58	56	55	51	44	37	63
4	Inlet	43	66	69	69	67	69	62	57	75
	Outlet	50	65	67	69	70	68	59	51	75
	Break-Out	38	54	56	55	54	54	44	37	62
5	Inlet	41	64	67	67	65	64	59	54	73
	Outlet	47	63	67	65	70	62	56	48	74
	Break-Out	36	53	55	53	52	48	41	33	60
6	Inlet	44	63	65	65	63	61	57	52	71
	Outlet	48	61	62	66	62	60	54	47	70
	Break-Out	40	52	53	51	51	46	39	32	58
7	Inlet	37	60	62	63	60	63	56	51	69
	Outlet	44	59	61	62	64	61	53	44	69
	Break-Out	32	48	50	48	47	47	38	30	55
8	Inlet	35	58	61	61	59	57	52	47	67
	Outlet	41	57	61	59	64	56	49	42	67
	Break-Out	30	46	49	47	46	42	35	27	53
9	Inlet	38	57	58	58	57	54	50	46	64
	Outlet	41	54	56	59	56	53	47	41	64
	Break-Out	33	46	47	45	44	40	33	26	52
10	Inlet	33	56	58	59	56	59	52	47	65
	Outlet	40	55	57	58	60	57	49	40	65
	Break-Out	28	44	46	44	43	43	34	26	51
11	Inlet	31	54	57	57	55	54	48	43	63
	Outlet	37	53	57	55	60	52	45	38	63
	Break-Out	26	43	45	43	42	38	31	23	50
12	Inlet	34	53	54	54	53	50	46	42	60
	Outlet	37	50	52	55	52	49	43	37	60
	Break-Out	29	42	43	41	40	36	29	22	48

Working point	63	125	250	500	1000	2000	4000	8000	LwA	
1	Inlet	51	73	75	75	73	77	68	63	82
	Outlet	58	73	74	76	77	75	67	57	83
	Break-out	46	61	63	61	60	60	50	43	68
2	Inlet	48	73	75	75	73	72	66	61	81
	Outlet	56	72	77	74	78	71	64	57	82
	Break-out	43	61	64	61	59	56	49	41	68
3	Inlet	54	73	74	73	72	70	65	61	80
	Outlet	58	71	72	75	72	69	62	56	79
	Break-out	49	62	63	59	58	54	48	41	67
4	Inlet	46	68	71	70	68	72	64	58	77
	Outlet	53	68	70	71	72	70	62	52	78
	Break-out	41	56	59	56	55	55	45	38	63
5	Inlet	44	68	71	70	68	67	61	56	76
	Outlet	52	67	72	69	74	66	59	52	77
	Break-out	39	56	59	56	55	51	44	36	63
6	Inlet	49	68	69	68	67	65	60	56	75
	Outlet	53	66	67	70	67	64	58	51	74
	Break-out	44	57	58	54	54	49	43	36	62
7	Inlet	40	62	64	64	62	66	57	52	71
	Outlet	47	62	63	65	66	64	56	46	71
	Break-out	35	50	52	50	49	49	39	32	57
8	Inlet	37	62	64	64	62	61	55	50	70
	Outlet	45	61	65	63	67	60	53	46	71
	Break-out	32	50	53	50	48	44	37	30	57
9	Inlet	42	61	63	62	60	59	54	50	68
	Outlet	46	60	61	64	61	57	51	45	68
	Break-out	38	50	52	48	47	43	37	30	56
10	Inlet	36	58	60	60	58	62	53	48	67
	Outlet	43	58	59	61	62	60	52	42	68
	Break-out	31	46	48	46	45	45	35	28	53
11	Inlet	33	58	60	60	58	57	51	46	66
	Outlet	41	57	62	59	63	56	49	42	67
	Break-out	28	46	49	46	44	40	33	26	53
12	Inlet	39	57	59	58	56	55	50	46	64
	Outlet	42	56	57	60	57	53	47	41	64
	Break-out	34	47	48	44	43	39	33	26	52

PERFORMANCE CURVES - ACOUSTIC CHARACTERISTICS

- q_v : Airflow in m^3/h .
- p_{st} : Static pressure in Pa.
- P: Input power in W.
- SFP: Specific fan power in $W/m^3/s$ (blue curves).
- Performance data in accordance with ISO 5801 and AMCA 210-99 Standards.

CVAT/4-12000/560N D 2,2kW

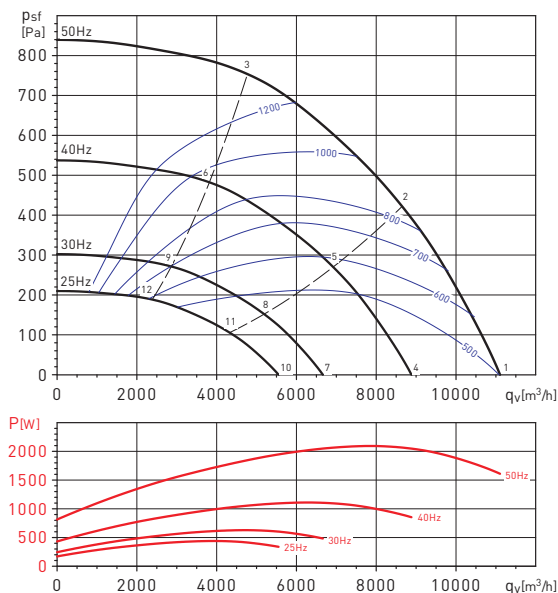

CVAT/4-16000/630N D 3kW

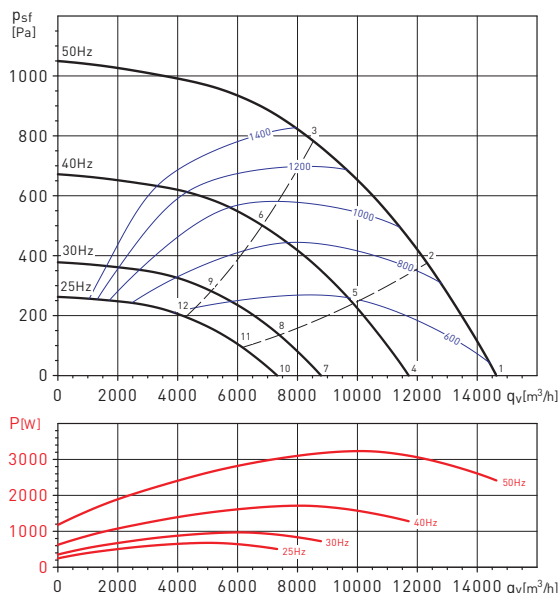

Working point		63	125	250	500	1000	2000	4000	8000	LwA
1	Inlet	55	77	79	78	76	81	72	66	86
	Outlet	63	78	78	81	81	78	71	60	87
	Break-Out	49	64	67	64	62	63	53	46	72
2	Inlet	51	76	78	77	76	75	69	64	84
	Outlet	60	76	80	77	81	73	67	60	85
	Break-Out	46	64	67	63	61	58	51	44	71
3	Inlet	56	75	76	74	73	72	67	63	81
	Outlet	60	74	74	78	74	70	64	58	81
	Break-Out	51	65	66	61	60	55	49	43	70
4	Inlet	50	72	74	73	71	76	67	61	81
	Outlet	58	73	73	76	76	74	66	55	82
	Break-Out	44	60	63	59	58	59	49	41	67
5	Inlet	46	71	73	72	71	70	64	59	79
	Outlet	55	71	75	72	76	68	62	55	81
	Break-Out	41	59	62	58	57	53	46	39	66
6	Inlet	51	70	71	69	68	67	62	58	77
	Outlet	55	69	69	73	69	65	59	53	77
	Break-Out	46	60	61	56	55	50	45	39	65
7	Inlet	44	66	68	67	65	70	61	55	75
	Outlet	52	67	67	69	70	67	60	49	76
	Break-Out	38	53	56	52	51	52	42	35	61
8	Inlet	39	65	67	66	64	64	57	52	73
	Outlet	49	65	69	66	70	62	56	49	74
	Break-Out	34	53	56	52	50	47	40	33	60
9	Inlet	45	64	65	63	62	61	56	52	70
	Outlet	49	63	62	66	62	59	53	47	70
	Break-Out	40	53	55	49	49	44	38	32	59
10	Inlet	40	62	64	63	61	66	57	51	71
	Outlet	48	63	63	65	66	63	56	45	72
	Break-Out	34	49	52	49	47	48	38	31	57
11	Inlet	36	61	63	62	61	60	53	48	69
	Outlet	45	61	65	62	66	58	52	45	70
	Break-Out	31	49	52	48	46	43	36	29	56
12	Inlet	41	60	61	59	58	57	52	48	66
	Outlet	45	59	59	62	59	55	49	43	66
	Break-Out	36	49	51	45	45	40	34	28	55

Working point		63	125	250	500	1000	2000	4000	8000	LwA
1	Inlet	57	79	81	80	78	84	74	68	88
	Outlet	67	82	81	84	84	81	74	62	90
	Break-Out	52	67	70	65	64	66	56	48	74
2	Inlet	53	79	82	80	78	78	71	66	87
	Outlet	64	81	84	81	85	76	70	64	89
	Break-Out	48	68	71	66	64	60	53	47	74
3	Inlet	61	81	81	78	78	77	71	68	87
	Outlet	66	81	79	84	79	75	69	64	88
	Break-Out	56	70	71	65	64	59	54	48	75
4	Inlet	53	75	77	75	74	79	69	63	83
	Outlet	62	77	76	79	79	76	69	57	85
	Break-Out	47	62	66	61	59	61	51	43	69
5	Inlet	48	75	77	75	74	74	66	61	82
	Outlet	60	76	79	76	80	72	65	59	84
	Break-Out	43	63	66	61	59	55	48	42	69
6	Inlet	56	76	77	74	73	72	67	63	82
	Outlet	61	76	74	79	74	71	64	59	83
	Break-Out	52	65	67	60	59	54	49	44	70
7	Inlet	46	68	70	69	67	73	63	57	77
	Outlet	56	70	70	73	73	70	63	51	78
	Break-Out	41	56	59	54	53	55	45	37	63
8	Inlet	42	68	71	69	67	67	60	55	76
	Outlet	53	69	73	69	74	65	59	53	78
	Break-Out	37	57	60	54	53	49	42	36	63
9	Inlet	50	70	70	67	67	66	60	57	76
	Outlet	55	70	68	72	68	64	58	53	76
	Break-Out	45	59	60	53	53	48	43	37	64
10	Inlet	42	64	66	65	63	69	59	53	73
	Outlet	52	67	66	69	69	66	59	47	74
	Break-Out	37	52	55	50	49	51	41	33	59
11	Inlet	38	64	67	65	63	63	56	51	72
	Outlet	49	65	69	65	70	61	55	49	74
	Break-Out	33	53	56	50	49	45	38	32	59
12	Inlet	46	66	66	63	63	62	56	53	72
	Outlet	51	66	64	69	64	60	54	49	72
	Break-Out	41	55	56	49	49	44	39	33	60

PERFORMANCE CURVES - ACOUSTIC CHARACTERISTICS

- q_v : Airflow in m^3/h .
- p_{st} : Static pressure in Pa.
- P: Input power in W.
- SFP: Specific fan power in $W/m^3/s$ (blue curves).
- Performance data in accordance with ISO 5801 and AMCA 210-99 Standards.

CVAT/6-15000/710N D 1,5kW

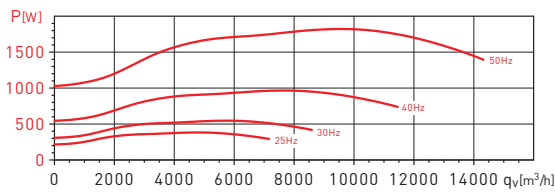
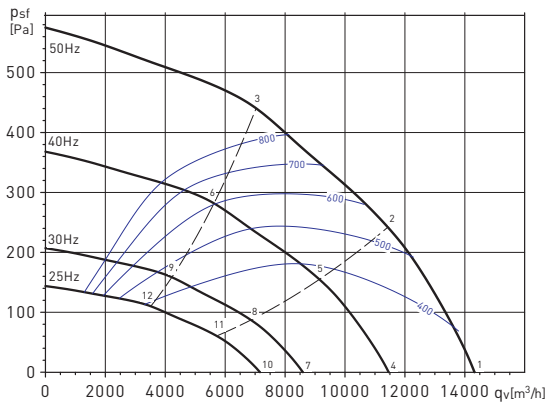

Working point	63	125	250	500	1000	2000	4000	8000	LwA	
1	Inlet	58	80	82	80	78	85	74	67	89
	Outlet	68	83	81	84	84	81	74	62	90
	Break-Out	53	69	72	66	65	67	56	48	75
2	Inlet	52	79	81	79	78	78	70	65	86
	Outlet	64	81	84	80	84	75	69	63	89
	Break-Out	48	68	72	65	63	60	53	47	75
3	Inlet	60	80	80	76	76	76	70	67	85
	Outlet	65	80	77	82	77	73	66	62	86
	Break-Out	56	71	72	63	62	57	53	48	75
4	Inlet	53	75	77	75	74	80	69	63	84
	Outlet	64	78	76	79	79	76	69	57	85
	Break-Out	48	64	67	61	60	62	51	43	71
5	Inlet	47	74	76	74	73	73	65	60	81
	Outlet	59	76	79	75	79	70	64	58	84
	Break-Out	43	63	67	60	58	55	48	43	70
6	Inlet	55	76	75	71	71	71	65	62	80
	Outlet	60	75	72	77	72	68	61	57	81
	Break-Out	51	66	67	58	57	52	48	43	70
7	Inlet	47	69	71	69	67	74	63	56	78
	Outlet	57	72	70	73	73	70	63	50	79
	Break-Out	42	57	61	55	53	56	45	37	64
8	Inlet	41	68	70	67	67	67	59	54	75
	Outlet	53	69	73	69	73	64	58	52	78
	Break-Out	37	57	61	54	52	49	42	36	64
9	Inlet	49	69	69	65	64	65	58	56	74
	Outlet	54	69	66	71	66	62	55	51	75
	Break-Out	45	60	61	52	51	46	42	37	64
10	Inlet	43	65	67	65	63	70	59	52	74
	Outlet	53	68	66	69	69	66	59	47	75
	Break-Out	38	53	57	51	50	52	41	33	60
11	Inlet	37	64	66	64	63	63	55	50	71
	Outlet	49	66	69	65	69	60	54	48	74
	Break-Out	33	53	57	50	48	45	38	32	60
12	Inlet	45	65	65	61	61	61	54	52	70
	Outlet	50	65	62	67	62	58	51	47	71
	Break-Out	41	56	57	48	47	42	38	33	60

MOUNTING ACCESSORIES



MBE
Electric heaters.

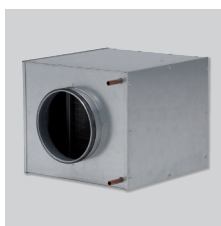

MBW
Hot water coil.



MFL-G4
Filtration boxes.



SIL
Sound attenuators.



ACOPEL F400 N
Circular flexible connector.



CRC
Circular reducers.



CTI CVA-N
Outdoor cover
For outdoor installations.



APC
Discharge protection guards for direct connection to the inlet-outlet flange (for more information see Mounting accessories).



KSE
Anti-vibration mounts.

CVAB-N / CVAT-N model	APC model	CTI CVA-N model
1400/250N D	APC-250	CTI CVA-N 250/315
2000/315N D	APC-315	CTI CVA-N 250/315
3000/355N D	APC-355	CTI CVA-N 355/400 CHAT-400/450
4000/400N D	APC-400	CTI CVA-N 355/400 CHAT-400/450
6000/450N D	APC-450	CTI CVA-N 450
9000/500N D	APC-500	CTI CVA-N 500 CHAT-500
12000/560N D	APC-560	CTI CVA-N 560
16000/630N D	APC-630	CTI CVA-N 630
15000/710N D	APC-710	CTI CVA-N 710

ELECTRICAL ACCESSORIES



REB
Single-phase electronic speed controller



RMB
Single-phase auto-transformer speed controller



AJUSTABLE FREQUENCY DRIVE VFKB
Die cast aluminium IP65 case. Simple to operate. Speed selection with potentiometer.



AJUSTABLE FREQUENCY DRIVE VFTM
IP21 o IP54 models. External display to adjust parameters.



SC02-A
CO₂ and temperature sensor.
SC02-AD
CO₂ and temperature sensor, with display.
SCHT-AD
CO₂, temperature and relative humidity sensor with display.



CPFL-S / CPFL-E
Presence detector.



TDP-S/TDP-D/TDP-PI
Pressure sensor.



REMP
Motorised damper.