

Range of direct-driven low pressure double inlet forward curve centrifugal fans. Casing and impeller manufactured from galvanized sheet steel. All models incorporate speed controllable external rotor motor, fitted with thermal protection and ball bearings.

Motors

IP44, Class F (models 7/7 and 7/9).
IP55, Class F (models 9/7 to 12/12).
IP54, Class F (models 12/12 1100W and 15/15 2200W).

4 or 6 pole depending on version.

Electrical supply:

Single phase 230V-50Hz, suitable for speed control by voltage.

Three phase 230/400V-50Hz, suitable for speed control by tension and frequency inverter.

[See characteristics chart].

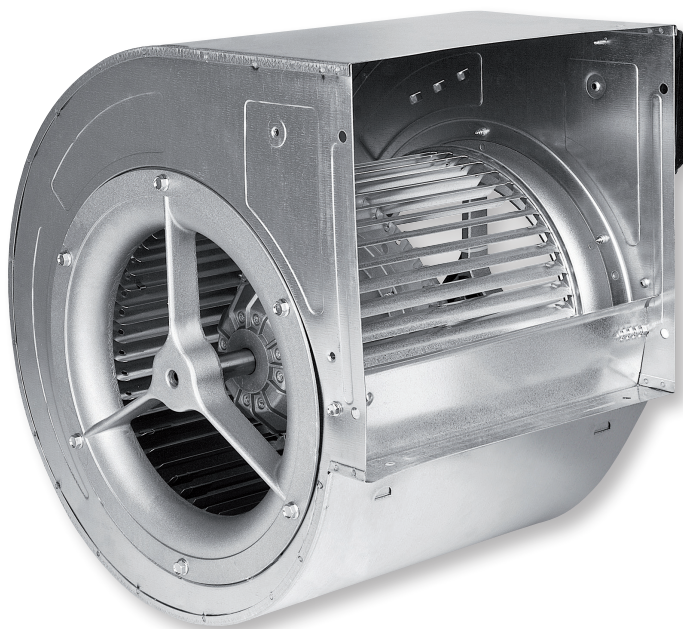

Impeller dynamically balanced

Impeller dynamically balanced, according to ISO 1940 standard, providing vibration free operation.



Anti-vibration mounts

All motors are fitted with support including rubber antivibration mounts reducing the noise transmitted to the installation.



CBM-7/7 72W and CBM-7/7 147W

Constructive configuration of models CBM-7/7 72W and CBM-7/7 147W.

TECHNICAL CHARACTERISTICS

Before installation check that the product electrical characteristics listed on the data plate label (voltage, power, frequency, etc.) match those of the intended electrical supply.

Model	Motor power (W)	Speed (r.p.m)	Equivalence (mm)	Capacitor (µF/V)	Maximum absorbed current (A)	Maximum airflow (m³/h)	Maximum temperature air (°C)	Sound pressure level * (dB(A))	Weight (kg)	Speed controller	
										REB	RMB
SINGLE PHASE MOTORS											
CBM-7/7 72W 6P RE VR	72	900	180/180	2,5/450	0,6	1.440	+70	56	6,5	1	1,5
CBM-7/7 147W 4P RE VR	147	1400	180/180	7/450	1,2	1.470	+40	63	6,9	2,5	1,5
CBM-7/7 300W 4P RE VR	300	1400	180/180	6/450	2,0	2.200	+60	64	7,2	2,5	3,5
CBM-7/9 72W 6P RE VR	72	900	180/240	2/450	0,9	1.850	+70	60	6,5	1	1,5
CBM-7/9 300W 4P RE VR	300	1400	180/240	6/450	2,2	2.530	+40	67	9,8	2,5	3,5
CBM-9/7 200W 6P RE VR	200	900	240/180	4/450	1,5	1.900	+40	59	13,5	2,5	1,5
CBM-9/7 245W 6P RE VR	245	900	240/180	13/450	2,0	2.650	+50	64	14	2,5	3,5
CBM-9/7 420W 4P RE VR	420	1400	240/180	15/450	3,2	2.600	+40	68	14,5	5	3,5
CBM-9/9 200W 6P RE VR	200	900	240/240	5/450	1,8	2.760	+40	63	14	2,5	3,5
CBM-9/9 245W 6P RE VR	245	900	240/240	13/450	2,2	2.870	+40	64	14,1	2,5	3,5
CBM-9/9 300W 4P RE VR	300	1400	240/240	20/450	2,8	2.500	+40	64	16,7	5	3,5
CBM-9/9 550W 4P RE VR	550	1400	240/240	20/450	4,3	3.470	+40	71	17,7	5	8
CBM-10/8 245W 6P RE VR	245	900	270/200	9/450	2,8	3.490	+40	67	14,9	5	3,5
CBM-10/8 515W 6P RE VR	515	900	270/200	10/450	3,3	3.750	+40	71	19,5	5	8
CBM-10/8 550W 4P RE VR	550	1400	270/200	20/450	4,2	2.900	+40	68	18,6	5	8
CBM-10/10 245W 6P RE VR	245	900	270/270	9/450	2,8	3.370	+40	64	16	5	3,5
CBM-10/10 515W 6P RE VR	515	900	270/270	10/450	3,4	4.090	+40	67	17,5	5	8
CBM-10/10 600W 4P RE VR	600	1400	270/270	20/450	4,6	3.300	+40	68	20,8	5	8
CBM-12/9 515W 6P RE VR	515	900	320/320	18/450	4,1	4.195	+40	65	21,5	5	8
CBM-12/9 750W 6P RE VR	750	900	320/240	20/450	5,5	4.990	+40	67	23,5	10	8
CBM-12/12 515W 6P RE VR	515	1400	320/320	18/450	4,2	4.540	+40	66	22	5	8
CBM-12/12 750W 6P RE VR	750	900	320/320	20/450	5,3	5240	+40	68	24	10	8

Model	Motor power (W)	Speed (r.p.m)	Equivalence (mm)	Maximum absorbed current (m³/h)		Max. airflow (m³/h)	Maximum temperature air (°C)	Sound pressure level * (dB(A))	Weight (kg)	Speed controller RMT	Inverter controller VFTM	
				230V	400V						Power supply	
											1/230V	3/400V

THREE PHASE MOTORS

CBM-7/7 250W 4P T RE VR	250	1400	180/180	1,2	0,7	2.320	+65	65	7,1	1,5	VFTM MONO 0,18	VFTM TRI 0,37
CBM-9/7 550W 4P T RE VR	550	1400	240/180	3,1	1,8	3.350	+40	70	14	2,5	VFTM MONO 0,37	VFTM TRI 0,55
CBM-9/9 245W 6P T RE VR	245	900	240/240	1,6	0,9	3.330	+40	67	14,1	1,5	VFTM MONO 0,37	VFTM TRI 0,37
CBM-9/9 550W 4P T RE VR	550	1400	240/240	5,5	3,2	4.830	+40	75	14,1	5	VFTM MONO 1,1	VFTM TRI 1,1
CBM-10/8 245W 6P T RE VR	245	900	270/200	1,9	1,1	3.470	+40	68	14,9	1,5	VFTM MONO 0,37	VFTM TRI 0,37
CBM-10/8 350W 6P T RE VR	350	900	270/200	2,8	1,6	4.330	+40	73	14,9	2,5	VFTM MONO 0,37	VFTM TRI 0,55
CBM-10/8 550W 4P T RE VR	550	1400	270/200	5,4	3,1	4.230	+40	72	18,9	5	VFTM MONO 1,1	VFTM TRI 1,1
CBM-10/10 245W 6P T RE VR	245	900	270/270	1,9	1,1	3.920	+40	67	16	1,5	VFTM MONO 0,37	VFTM TRI 0,37
CBM-10/10 350W 6P T RE VR	350	900	270/270	2,9	1,7	5.000	+40	72	20	2,5	VFTM MONO 0,37	VFTM TRI 0,55
CBM-10/10 550W 4P T RE VR	550	1400	270/270	5,0	2,9	4.010	+40	70	20	5	VFTM MONO 1,1	VFTM TRI 1,1
CBM-10/10 750W 4P T RE VR	750	1400	270/270	7,6	4,4	5.880	+40	76	20	5	VFTM MONO 1,5	VFTM TRI 1,5
CBM-12/12 550W 6P T RE VR	550	900	320/320	5,0	2,9	6.490	+40	73	22	5	VFTM MONO 1,1	VFTM TRI 1,1
CBM-12/12 750W 6P T RE VR	750	900	320/320	5,9	3,4	7.480	+40	75	22	5	VFTM MONO 1,1	VFTM TRI 1,5
CBM-12/12 1100W 6P T RE VR	1100	900	320/320	5,7	3,3	7.410	+40	75	25	5	VFTM MONO 1,1	VFTM TRI 1,5
CBM-15/15 2200W 6P T RE VR K	2200	900	380/380	12,2	7	11.650	+40	75	43	8	-	VFTM TRI 3

* Sound pressure levels in dB(A), measured at 1,5 meters at the fan inlet side in free field.

DIMENSIONS (mm)

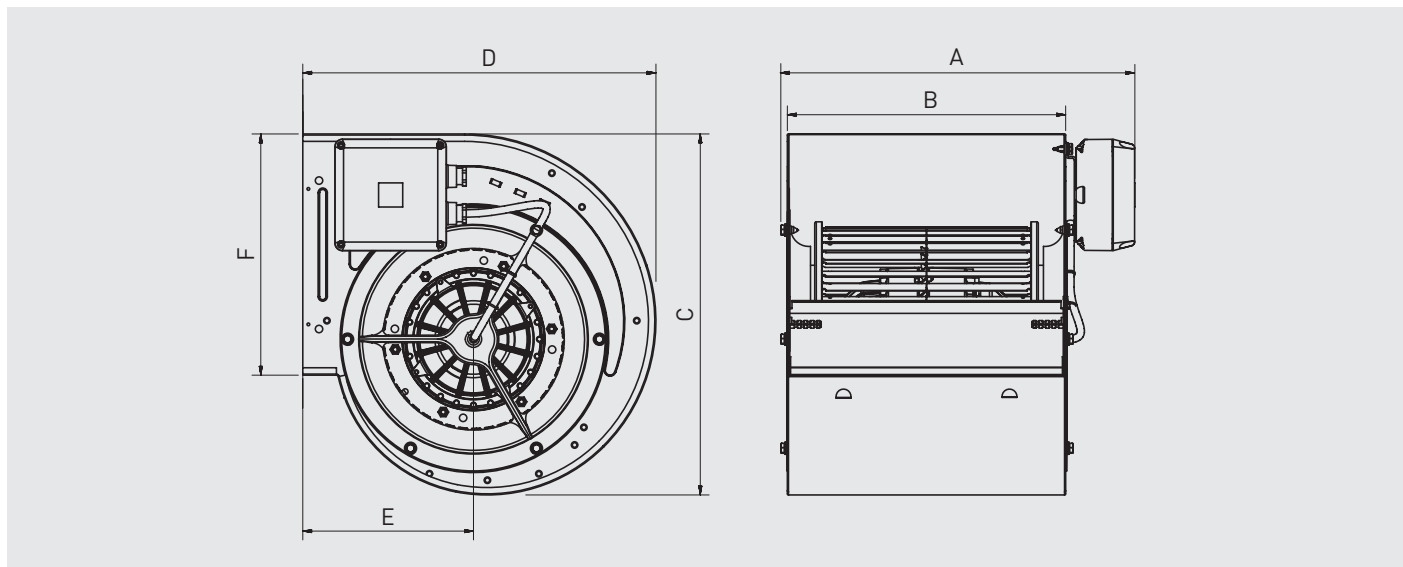

Model	A	B	C	D	E	F
CBM-7/7	296	233	328	309	145	207
CBM-7/9	363	300	328	309	145	207
CBM-9/7	316	233	390	381	184	260
CBM-9/9	382	300	390	381	184	260
CBM-10/8	340	267	443	423	200	288
CBM-10/10	407	333	443	423	200	288
CBM-12/9	382	311	521	490	229	341
CBM-12/12	466	396	521	490	229	341

DIMENSIONS MODEL CBM-15/15 2200 6PT RE VR K (mm)

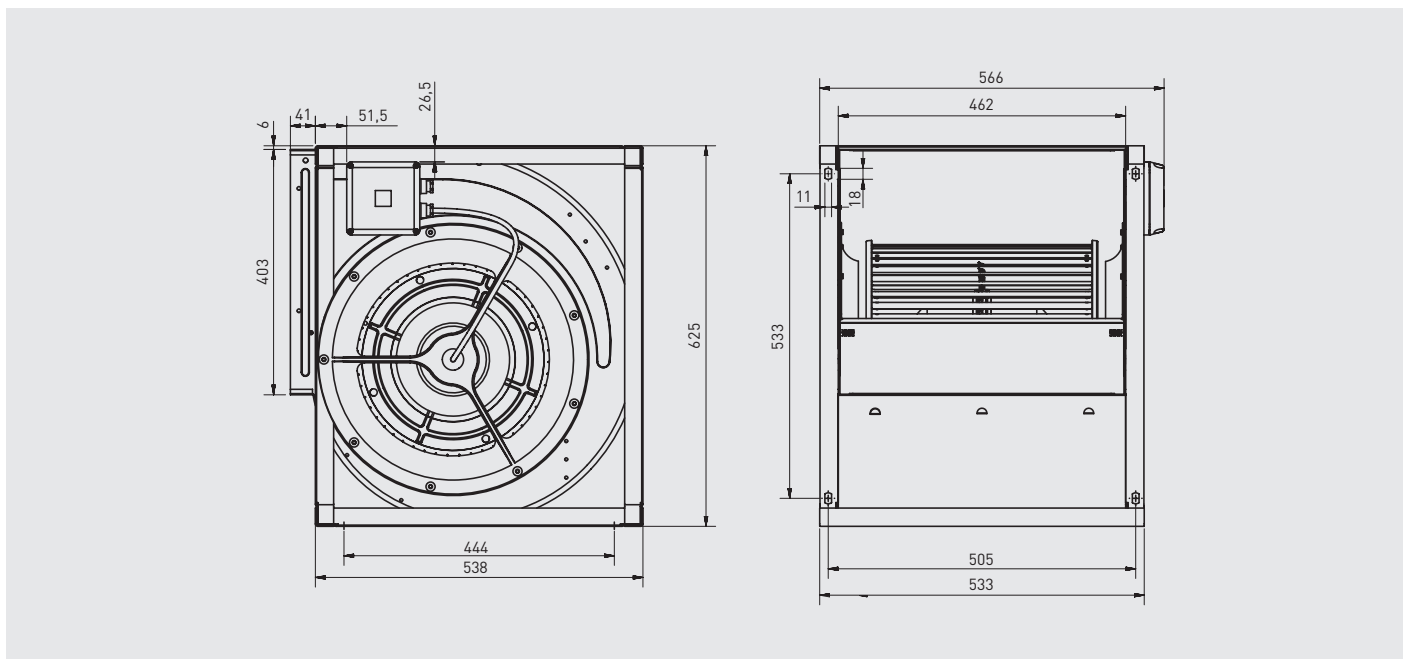

MOUNTING ACCESSORIES

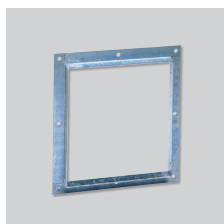

Outlet flange CBM



Mounting feet

Model	Outlet flange CBM	Mounting feet	Inlet guard
CBM-7/7	BRIDA DESCARGA CBM-7/7	PIE SOPORTE CBM-RE-7	DEF-CBM-RE-7
CBM-7/9	BRIDA DESCARGA CBM-7/9	PIE SOPORTE CBM-RE-7	DEF-CBM-RE-7
CBM-9/7	BRIDA DESCARGA CBM-9/7	PIE SOPORTE CBM-RE-9	DEF-CBM-RE-9
CBM-9/9	BRIDA DESCARGA CBM-9/9	PIE SOPORTE CBM-RE-9	DEF-CBM-RE-9
CBM-10/8	BRIDA DESCARGA CBM-10/8	PIE SOPORTE CBM-RE-10	DEF-CBM-RE-10
CBM-10/10	BRIDA DESCARGA CBM-10/10	PIE SOPORTE CBM-RE-10	DEF-CBM-RE-10
CBM-12/9	BRIDA DESCARGA CBM-12/9	PIE SOPORTE CBM-RE-12	DEF-CBM-RE-12
CBM-12/12	BRIDA DESCARGA CBM-12/12	PIE SOPORTE CBM-RE-12	DEF-CBM-RE-12

ACCESSORIES DIMENSIONS (mm)

Outlet flange CBM

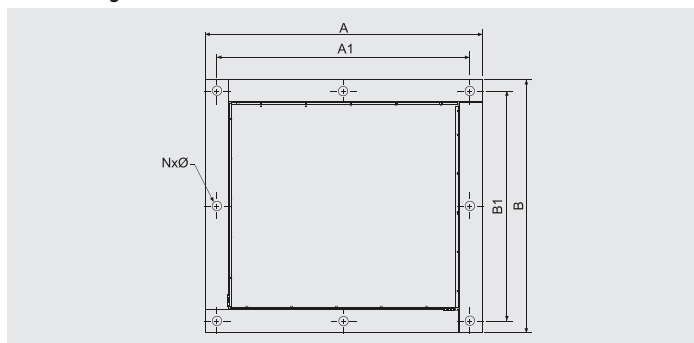

Model	A	A1	B	B1	NxØ (mm)
BRIDA DESCARGA CBM-7/7	289	264	265	240	8x9
BRIDA DESCARGA CBM-7/9	314	297	253	231	8x9
BRIDA DESCARGA CBM-9/7	273	253	302	280	8x9
BRIDA DESCARGA CBM-9/9	360	328	315	285	8x10
BRIDA DESCARGA CBM-10/8	314	293	339	316	8x9
BRIDA DESCARGA CBM-10/10	380,5	359	339	316	8x9
BRIDA DESCARGA CBM-12/9	362	341	394,5	374	8x9
BRIDA DESCARGA CBM-12/12	447	426	394,5	374	8x9

Mounting feet

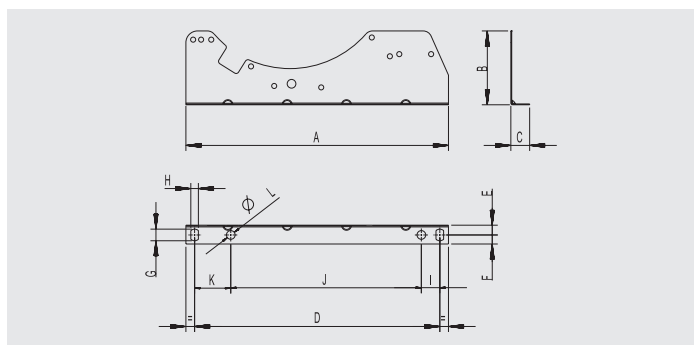

Model	A	B	C	D	E	F	G	H	I	J	K	L
7/	246	39	26	225	14	12	16	11	15	195	15	12
9/	320	89	26	307	13	13	16	11	-	-	35,7	10,5
10/	363	80	26	339	13,5	12,5	16	10,5	25,5	263,5	50	12
12/	430	115	26	407	13,5	12,5	16	10,5	48	333,5	25,5	12



PERFORMANCE CURVES

- q_v : Airflow in m^3/h .
- p_{sf} : Static pressure in Pa.
- SFP: Specific fan power in $W/m^3/s$.
- I: Absorbed power A.
- LW: Sound power levels, at inlet, in dB(A).
- Measurement category: B.
- Efficiency category: total.
- Fan efficiency without speed control.
- Airflow data in accordance with ISO 5801.

- MC** Measurement category
- EC** Efficiency category
- VSD** Speed control: supplied with the fan
- SR** Specific ratio
- η [%] Efficiency
- N** Efficiency grade
- [kW]** Absorbed power
- [m³/h]** Airflow
- [Pa]** Static pressure
- [RPM]** Speed

EXAMPLE CURVE

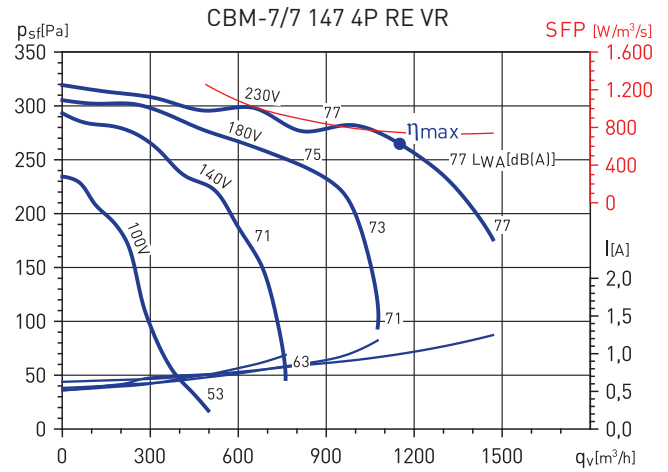

MC*	EC*	VSD*	SR*	η [%]*	N*	[kW]	[m ³ /h]	[Pa]	[RPM]
B	Total	No	1	39,0	49,3	0,239	1.150	292	1346

PERFORMANCE CURVES - Single phase motor

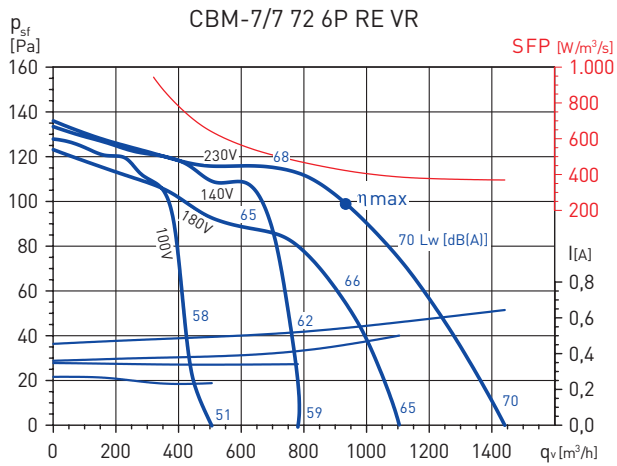

MC*	EC*	VSD*	SR*	η[%]*	N*	[kW]	[m³/h]	[Pa]	[RPM]
B	Total	No	1	27,7	40,1	0,110	933	117	883

* See example curve.

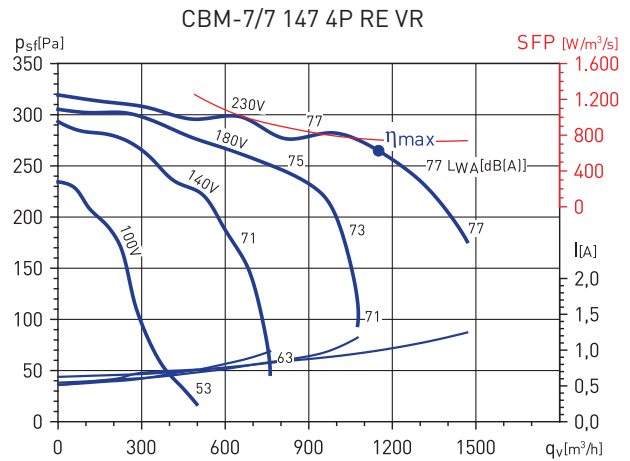

MC*	EC*	VSD*	SR*	η[%]*	N*	[kW]	[m³/h]	[Pa]	[RPM]
B	Total	No	1	39,0	49,3	0,239	1.150	292	1346

* See example curve.

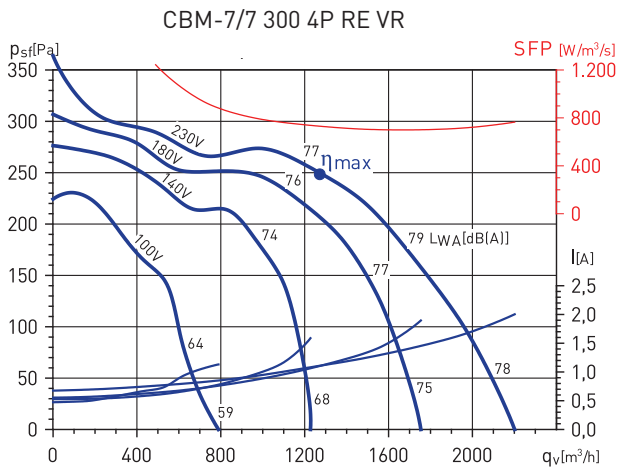

MC*	EC*	VSD*	SR*	η[%]*	N*	[kW]	[m³/h]	[Pa]	[RPM]
B	Total	No	1	39,1	49,1	0,258	1.270	286	1370

* See example curve.

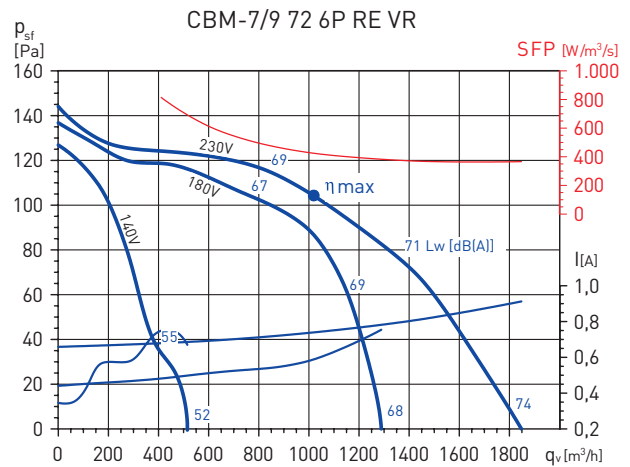

MC*	EC*	VSD*	SR*	η[%]*	N*	[kW]	[m³/h]	[Pa]	[RPM]
B	Total	No	1	27,4	39,5	0,120	1.020	116	920

* See example curve.

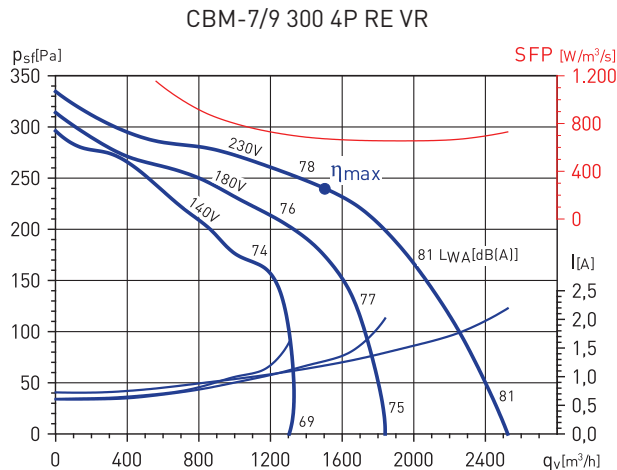

MC*	EC*	VSD*	SR*	η[%]*	N*	[kW]	[m³/h]	[Pa]	[RPM]
B	Total	No	1	39,5	49,3	0,283	1.508	266	1343

* See example curve.

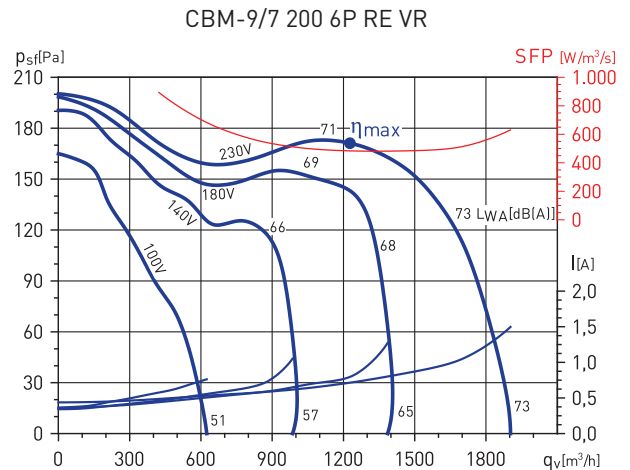

MC*	EC*	VSD*	SR*	η[%]*	N*	[kW]	[m³/h]	[Pa]	[RPM]
B	Total	No	1	39,5	50,8	0,165	1.227	191	914

* See example curve.

PERFORMANCE CURVES - Single phase motor

CBM-9/7 245 6P RE VR

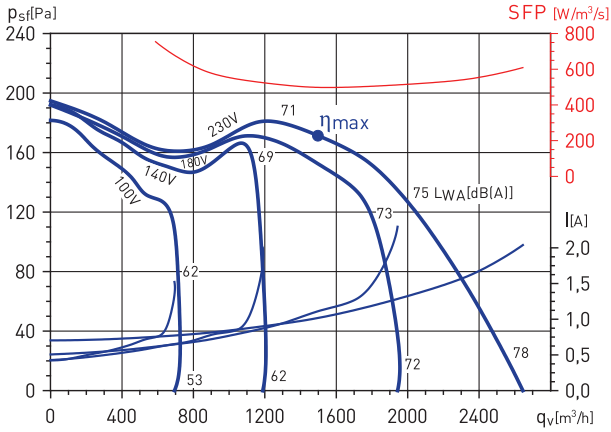

MC*	EC*	VSD*	SR*	η[%]*	N*	[kW]	[m³/h]	[Pa]	[RPM]
B	Total	No	1	40,0	50,6	0,207	1.495	200	951

* See example curve.

CBM-9/7 420 4P RE VR

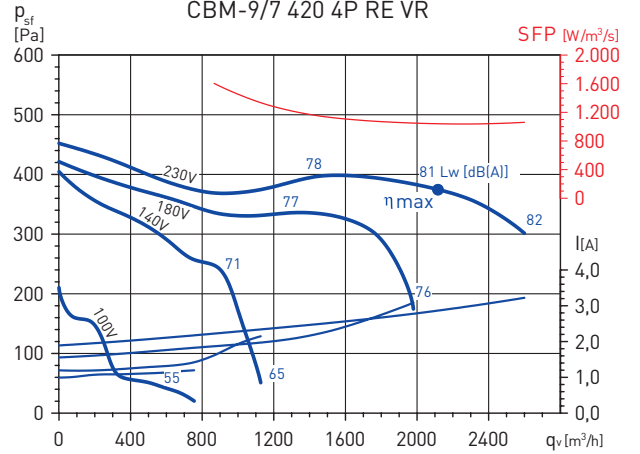

MC*	EC*	VSD*	SR*	η[%]*	N*	[kW]	[m³/h]	[Pa]	[RPM]
B	Total	No	1	41,3	49,0	0,612	2.118	429	1377

* See example curve.

CBM-9/9 200 6P RE VR

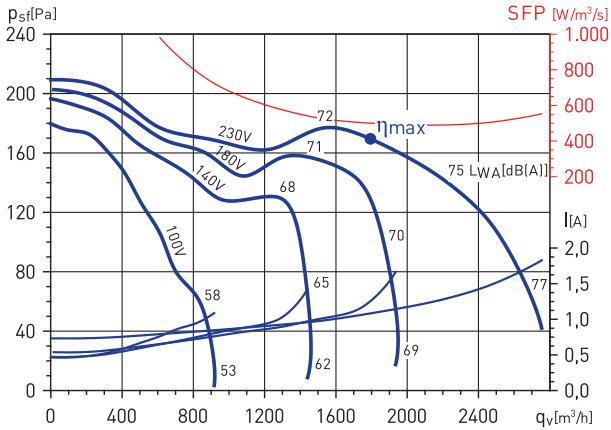

MC*	EC*	VSD*	SR*	η[%]*	N*	[kW]	[m³/h]	[Pa]	[RPM]
B	Total	No	1	38,9	49,0	0,249	1.792	195	915

* See example curve.

CBM-9/9 245 6P RE VR

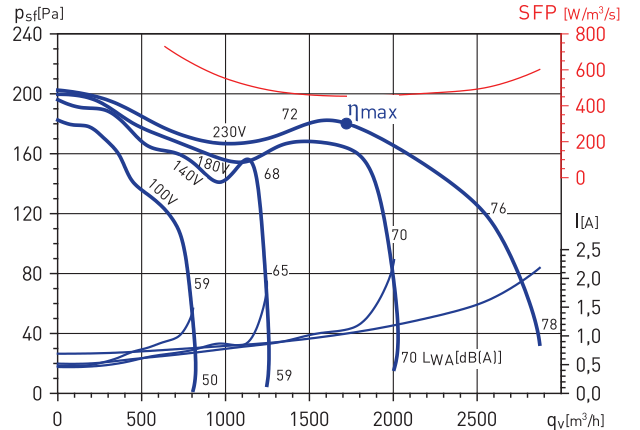

MC*	EC*	VSD*	SR*	η[%]*	N*	[kW]	[m³/h]	[Pa]	[RPM]
B	Total	No	1	44,5	55,0	0,215	1.714	201	947

* See example curve.

CBM-9/9 300 4P RE VR

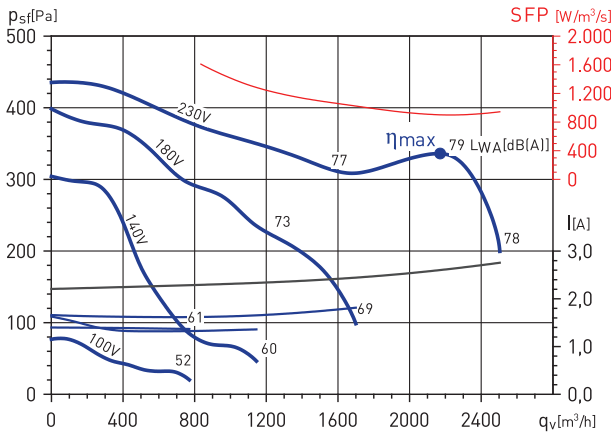

MC*	EC*	VSD*	SR*	η[%]*	N*	[kW]	[m³/h]	[Pa]	[RPM]
B	Total	No	1	41,1	49,1	0,545	2.177	374	1277

* See example curve.

CBM-9/9 550 4P RE VR

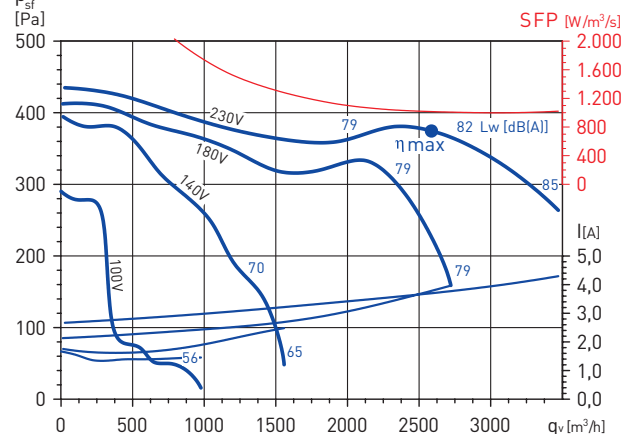

MC*	EC*	VSD*	SR*	η[%]*	N*	[kW]	[m³/h]	[Pa]	[RPM]
B	Total	No	1	41,8	49,0	0,730	2.588	424	1387

* See example curve.

PERFORMANCE CURVES - Single phase motor

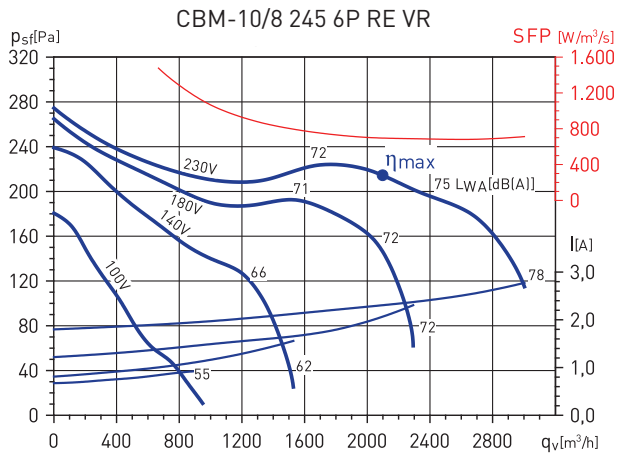

MC*	EC*	VSD*	SR*	η[%]*	N*	[kW]	[m³/h]	[Pa]	[RPM]
B	Total	No	1	45,5	54,3	0,405	2.336	284	949

* See example curve.

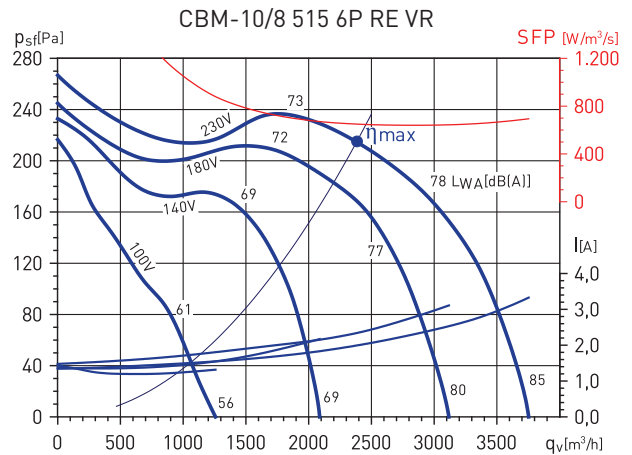

MC*	EC*	VSD*	SR*	η[%]*	N*	[kW]	[m³/h]	[Pa]	[RPM]
B	Total	No	1	40,4	49,0	0,430	2.382	262	917

* See example curve.

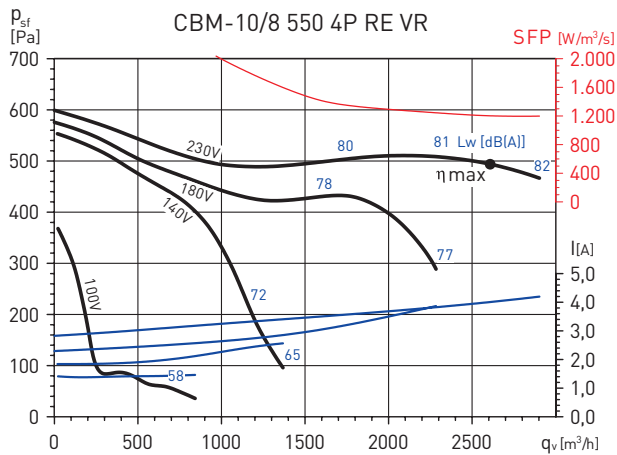

MC*	EC*	VSD*	SR*	η[%]*	N*	[kW]	[m³/h]	[Pa]	[RPM]
B	Total	No	1	45,1	51,8	0,872	2.610	542	1353

* See example curve.

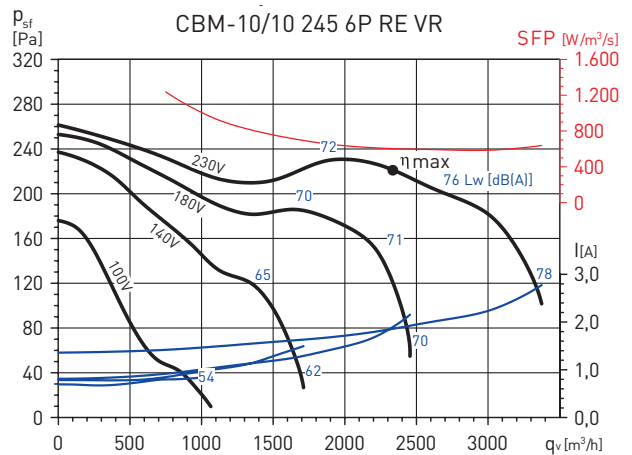

MC*	EC*	VSD*	SR*	η[%]*	N*	[kW]	[m³/h]	[Pa]	[RPM]
B	Total	No	1	41,0	49,9	0,391	2.334	248	905

* See example curve.

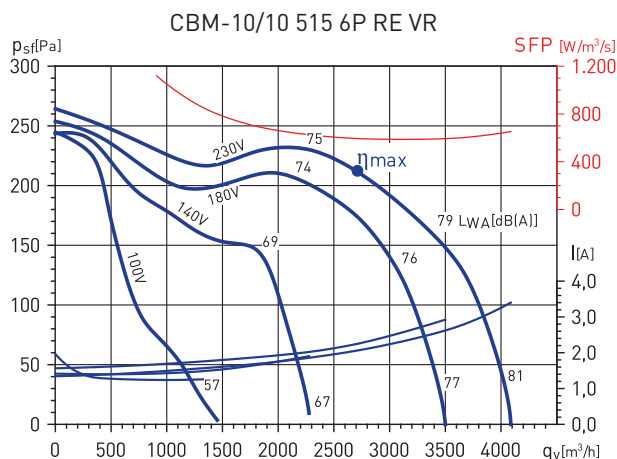

MC*	EC*	VSD*	SR*	η[%]*	N*	[kW]	[m³/h]	[Pa]	[RPM]
B	Total	No	1	42,6	51,2	0,440	2.654	254	914

* See example curve.

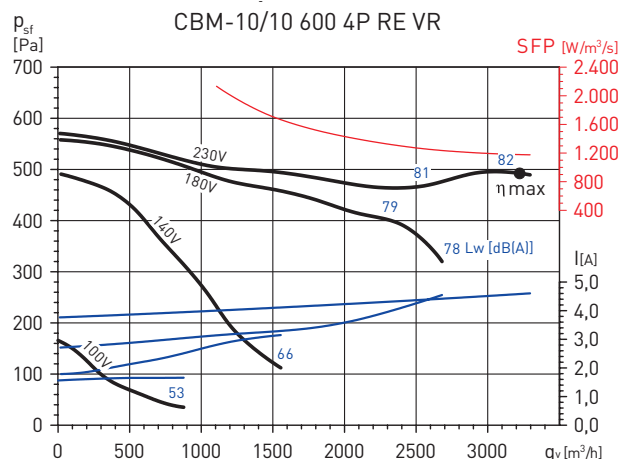

MC*	EC*	VSD*	SR*	η[%]*	N*	[kW]	[m³/h]	[Pa]	[RPM]
B	Total	No	1	45,9	52,1	1,056	3.226	542	1357

* See example curve.

PERFORMANCE CURVES - Single phase motor

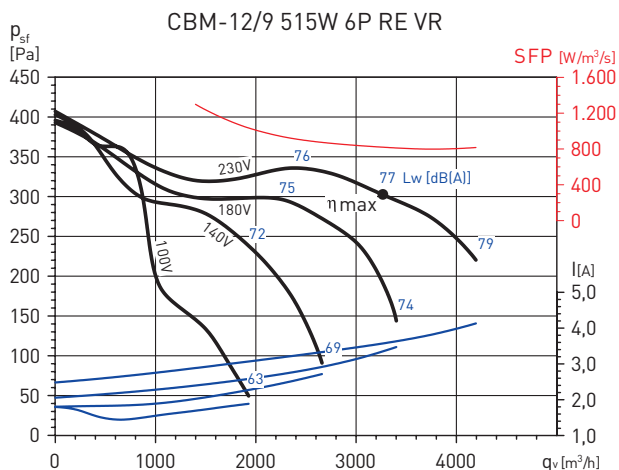

MC*	EC*	VSD*	SR*	η[%]*	N*	[kW]	[m³/h]	[Pa]	[RPM]
B	Total	No	1	42,6	49,7	0,744	3.267	349	885

* See example curve.

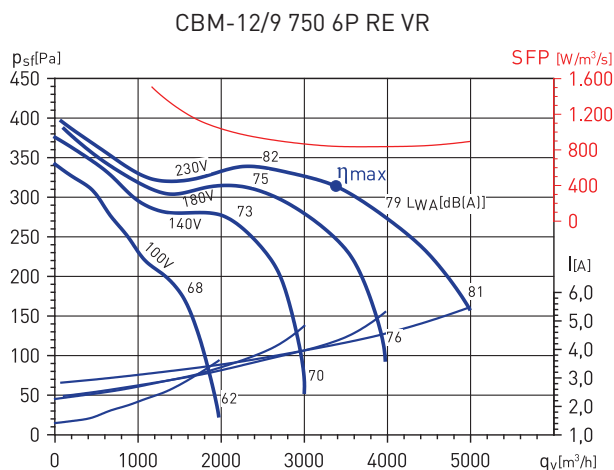

MC*	EC*	VSD*	SR*	η[%]*	N*	[kW]	[m³/h]	[Pa]	[RPM]
B	Total	No	1	42,9	49,9	0,788	3.380	360	913

* See example curve.

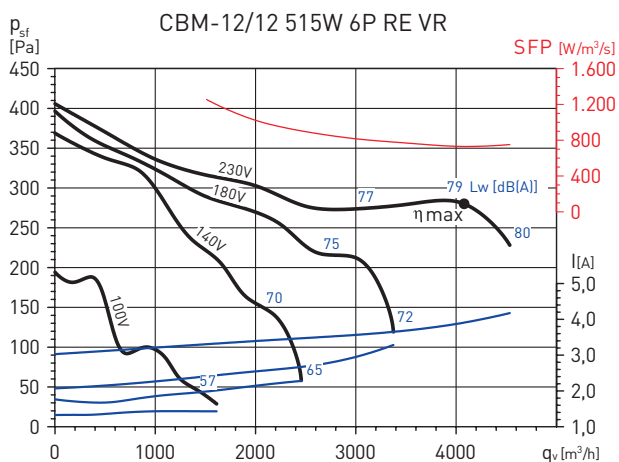

MC*	EC*	VSD*	SR*	η[%]*	N*	[kW]	[m³/h]	[Pa]	[RPM]
B	Total	No	1	43,8	50,7	0,826	4.084	323	865

* See example curve.

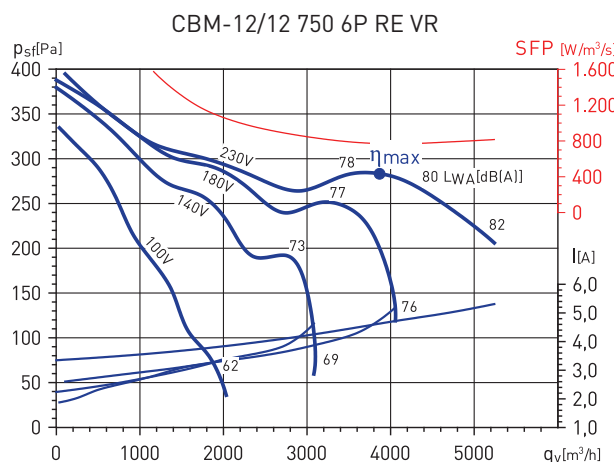

MC*	EC*	VSD*	SR*	η[%]*	N*	[kW]	[m³/h]	[Pa]	[RPM]
B	Total	No	1	42,3	49,1	0,832	3.900	325	899

* See example curve.

PERFORMANCE CURVES - Three phase motor

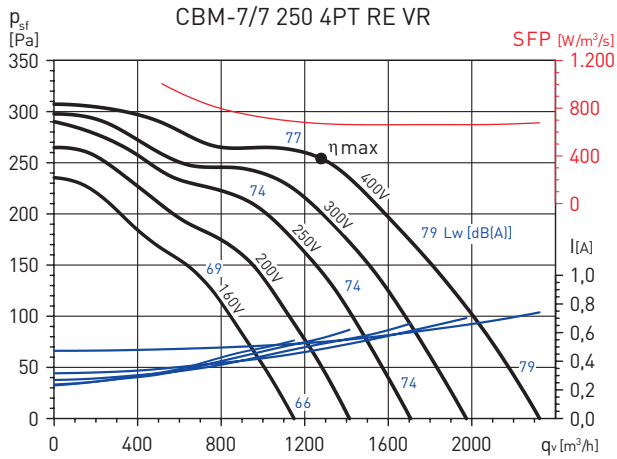

MC*	EC*	VSD*	SR*	η[%]*	N*	[kW]	[m³/h]	[Pa]	[RPM]
B	Total	No	1	45,2	55,5	0,238	1.280	303	1359

* See example curve.

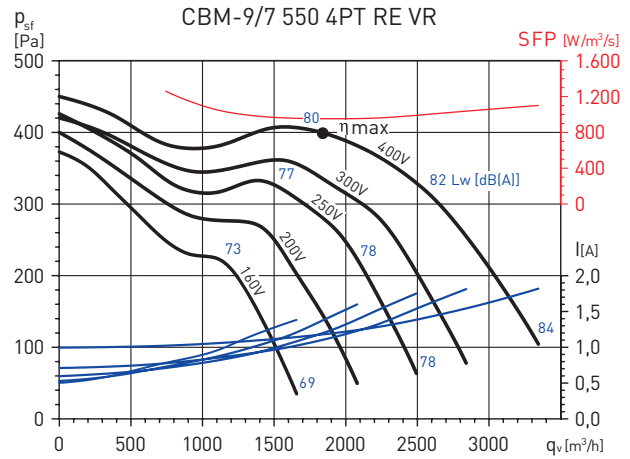

MC*	EC*	VSD*	SR*	η[%]*	N*	[kW]	[m³/h]	[Pa]	[RPM]
B	Total	No	1	46,7	55,0	0,487	1.839	445	1396

* See example curve.

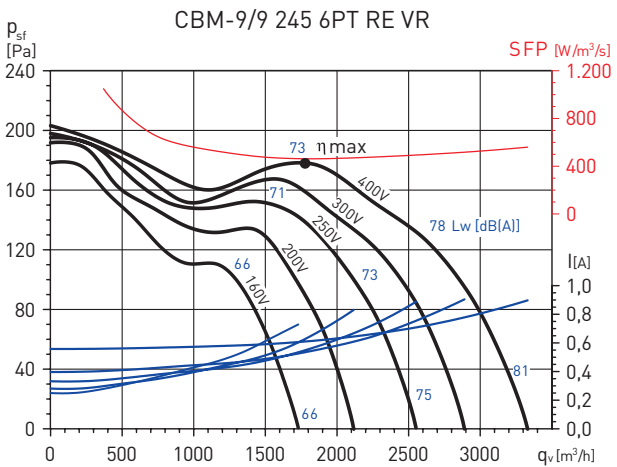

MC*	EC*	VSD*	SR*	η[%]*	N*	[kW]	[m³/h]	[Pa]	[RPM]
B	Total	No	0	43,9	54,3	0,230	1.787	203	947

* See example curve.

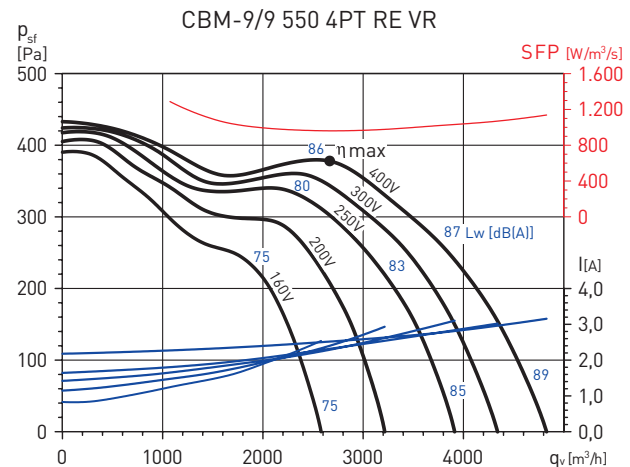

MC*	EC*	VSD*	SR*	η[%]*	N*	[kW]	[m³/h]	[Pa]	[RPM]
B	Total	No	1	44,9	52,2	0,711	2.663	433	1430

* See example curve.

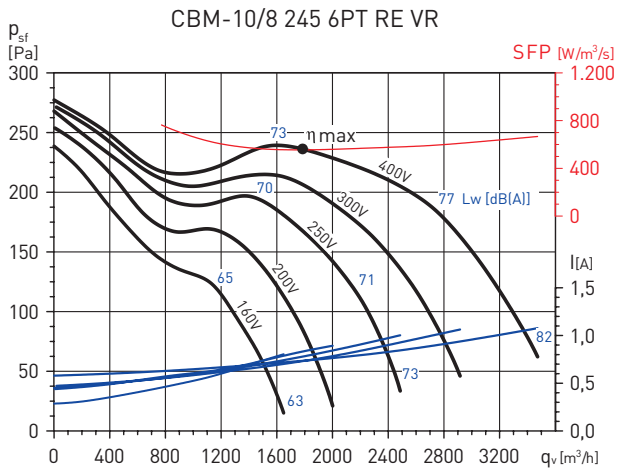

MC*	EC*	VSD*	SR*	η[%]*	N*	[kW]	[m³/h]	[Pa]	[RPM]
B	Total	No	1	46,6	56,5	0,273	1.774	258	931

* See example curve.

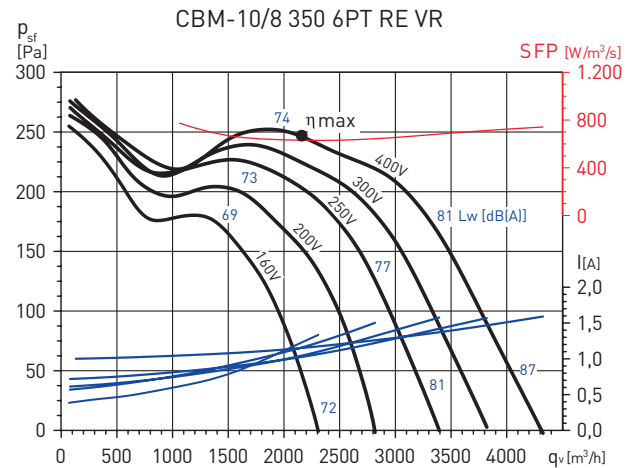

MC*	EC*	VSD*	SR*	η[%]*	N*	[kW]	[m³/h]	[Pa]	[RPM]
B	Total	No	1	44,3	53,3	0,377	2.147	280	954

* See example curve.

PERFORMANCE CURVES - Three phase motor

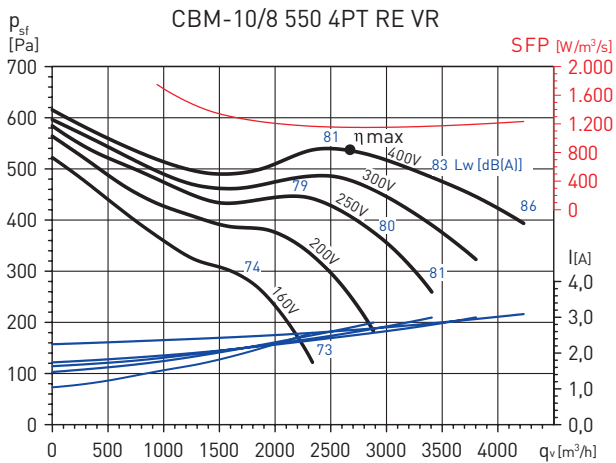

MC*	EC*	VSD*	SR*	η[%]*	N*	[kW]	[m³/h]	[Pa]	[RPM]
B	Total	No	1	50,5	57,3	0,853	2.668	581	1409

* See example curve.

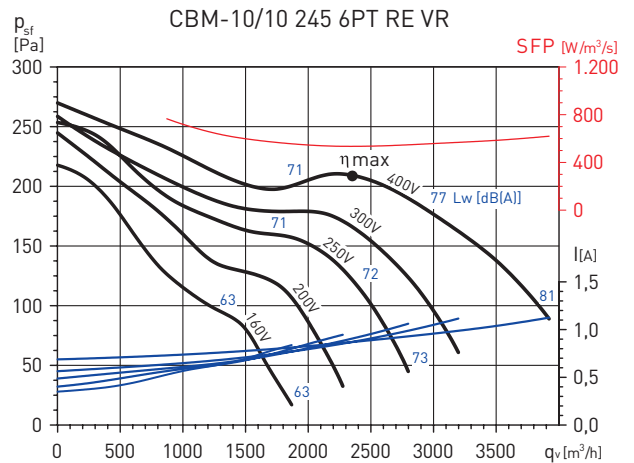

MC*	EC*	VSD*	SR*	η[%]*	N*	[kW]	[m³/h]	[Pa]	[RPM]
B	Total	No	1	43,8	53	0,35	2.357	234	906

* See example curve.

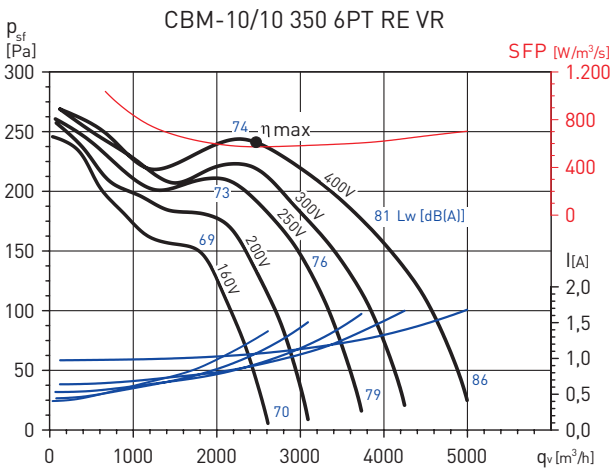

MC*	EC*	VSD*	SR*	η[%]*	N*	[kW]	[m³/h]	[Pa]	[RPM]
B	Total	No	1	46,9	55,8	0,393	2.465	269	949

* See example curve.

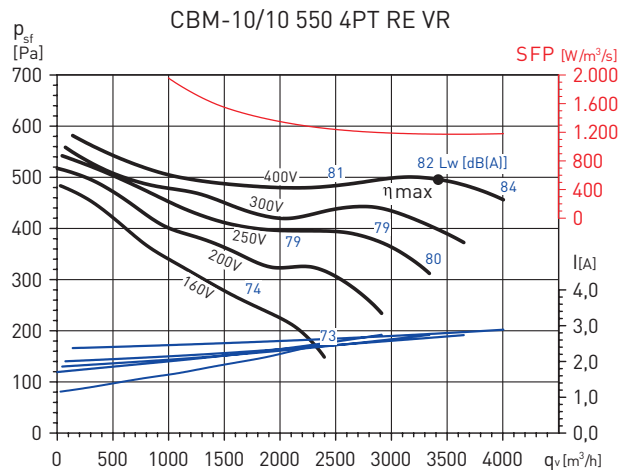

MC*	EC*	VSD*	SR*	η[%]*	N*	[kW]	[m³/h]	[Pa]	[RPM]
B	Total	No	1	46,9	52,9	1,116	3.422	550	1373

* See example curve.

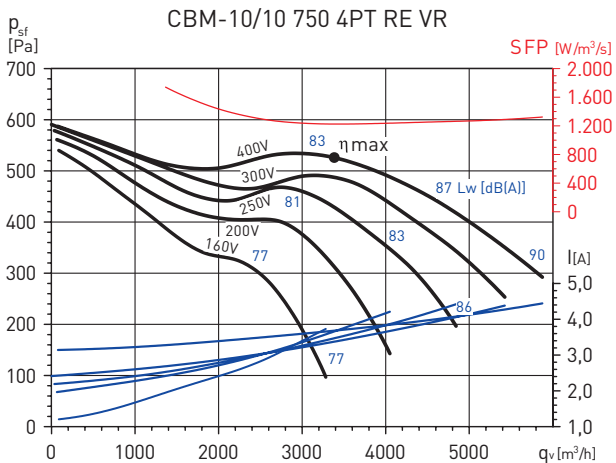

MC*	EC*	VSD*	SR*	η[%]*	N*	[kW]	[m³/h]	[Pa]	[RPM]
B	Total	No	1	47,8	53,7	1,150	3.379	586	1.431

* See example curve.

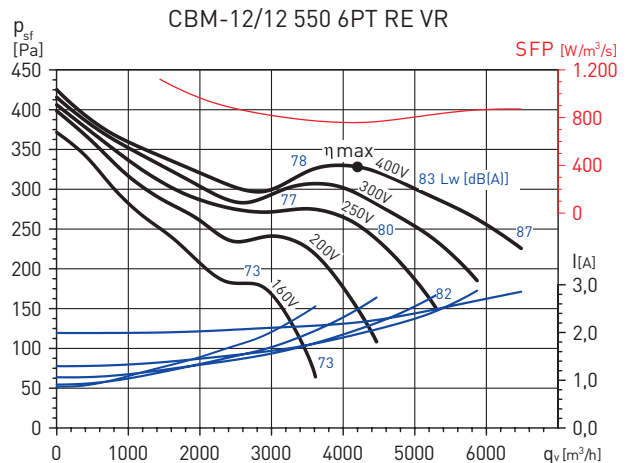

MC*	EC*	VSD*	SR*	η[%]*	N*	[kW]	[m³/h]	[Pa]	[RPM]
B	Total	No	1	50,7	57,4	0,886	4.202	387	939

* See example curve.

PERFORMANCE CURVES - Three phase motor

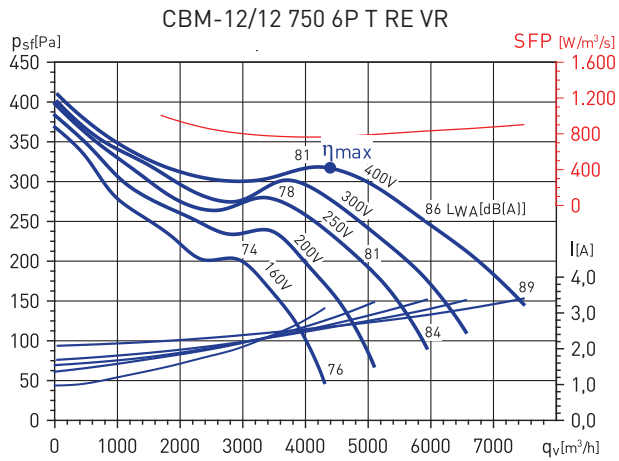

MC*	EC*	VSD*	SR*	η[%]*	N*	[kW]	[m³/h]	[Pa]	[RPM]
B	Total	No	1	47,9	54,4	0,937	4.397	368	936

* See example curve.

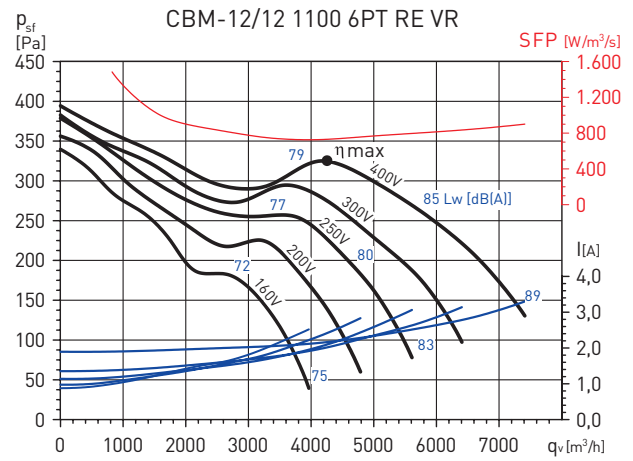

MC*	EC*	VSD*	SR*	η[%]*	N*	[kW]	[m³/h]	[Pa]	[RPM]
B	Total	No	1	51,0	57,7	0,862	4.247	373	925

* See example curve.

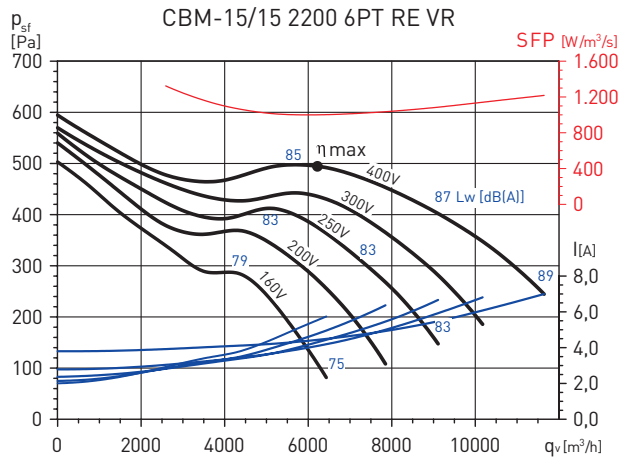

MC*	EC*	VSD*	SR*	η[%]*	N*	[kW]	[m³/h]	[Pa]	[RPM]
B	Total	No	1	54,7	59,5	1,725	6.209	547	934

* See example curve.