



Range of centrifugal roof fans which are mounted directly above a circular duct for the ventilation of housings and small enclosures.

Centrifugal backward curved impeller in galvanised sheet steel.

Galvanised steel sheet housing protected by black epoxy polyester paint.

All models are fitted with bird proof guard. 4 different sizes for diameter ducts 160, 200, 250 and 315 mm.

ON-OFF switch IP55.

Duct connection flange with integrated rubber air seal and thermal protector.

Motors

All motors are IP55, Class F, direct drive.

Electrical supply:

Single phase motor 230V 50Hz.

Variable voltage.

Working temperature: -40°C/+70°C.

Specific applications



Multi dwelling blocks

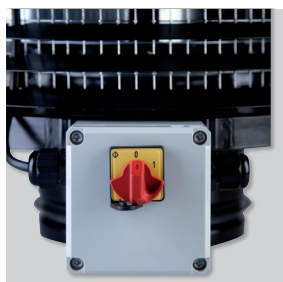

Isolation switch

On-Off electrical isolation switch fitted on the fan as standard.

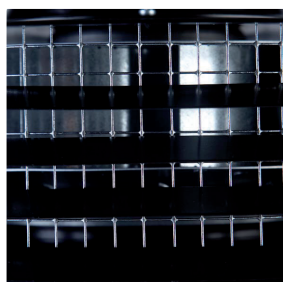

Bird proof guard

Steel finger proof guard.

TECHNICAL CHARACTERISTICS

Before installation check that the product electrical characteristics listed on the data plate label (voltage, power, frequency, etc.) match those of the intended electrical supply.

Model	Speed (rpm)	Maximum absorbed power (W)	Maximum absorbed current (A)	Maximum airflow (m³/h)	Sound pressure level at 3 m* (dB(A))		Weight (kg)
					Inlet	Outlet	
CTB/4-400/160	1360	30	0,14	450	34	41	5,5
CTB/4-500/200	1450	49	0,21	570	38	44	6,5
CTB/4-800/250	1390	57	0,25	810	36	42	8,0
CTB/4-1300/315	1350	116	0,49	1.420	42	48	9,0

* Sound power level at the midpoint of the curve.

DIMENSIONS (mm)

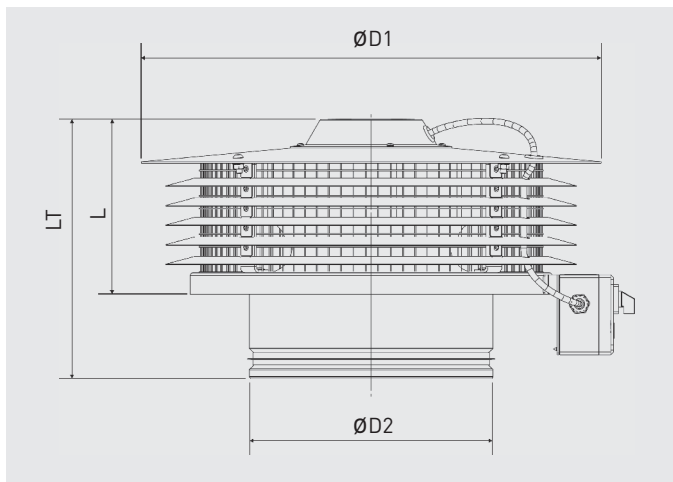

Model	D1	D2	L1	LT
CTB/4-400/160	410	159	143	229
CTB/4-500/200	410	199	156	242
CTB/4-800/250	470	249	179	266
CTB/4-1300/315	470	314	202	288

ACOUSTIC CHARACTERISTICS

Sound power spectrum: The sound levels shown in these tables are sound power levels at the outlet and inlet, in dB(A) for frequency ranges at three points of the curve: A - free outlet, B - medium pressure, C - maximum pressure.

CTB/4-400/160	63	125	250	500	1000	2000	4000	8000	LwA	LpA*
Inlet	A	31	39	44	50	51	52	53	39	58
	B	29	37	42	47	48	48	44	34	53
	C	34	40	44	47	46	45	40	32	52
Outlet	A	32	41	48	54	59	60	56	42	64
	B	31	39	45	51	55	57	48	37	60
	C	34	41	47	50	53	54	44	36	58

CTB/4-500/200	63	125	250	500	1000	2000	4000	8000	LwA	LpA*
Inlet	A	33	45	47	51	53	53	57	44	60
	B	32	45	45	49	51	50	51	41	57
	C	31	46	44	47	48	48	47	39	55
Outlet	A	32	45	50	56	60	61	61	47	66
	B	32	44	48	53	58	59	56	44	63
	C	32	44	46	51	56	57	51	42	60

CTB/4-800/250	63	125	250	500	1000	2000	4000	8000	LwA	LpA*
Inlet	A	32	45	50	56	56	55	61	49	64
	B	29	41	46	52	52	51	52	45	58
	C	42	51	52	53	53	51	49	43	59
Outlet	A	31	44	54	60	63	64	63	51	69
	B	29	42	48	55	59	60	55	47	64
	C	42	51	53	57	60	60	54	46	65

CTB/4-1300/315	63	125	250	500	1000	2000	4000	8000	LwA	LpA*
Inlet	A	42	51	56	60	60	58	62	53	67
	B	37	46	52	56	56	55	56	48	62
	C	41	48	51	54	55	53	52	47	60
Outlet	A	42	52	61	65	68	68	66	58	73
	B	40	47	56	60	64	64	60	52	69
	C	43	49	55	59	63	62	57	51	67

* Sound pressure level dB(A) measured at 3 m, in free field conditions.

PERFORMANCE CURVES

- q_v : Airflow rate in m^3/h .
- p_{sf} : Static pressure in mmWG and Pa.
- P: Power consumption in W.
- SFP: Specific power factor in $W/m^3/s$ (blue curves).
- Performance data in accordance with ISO 5801 and AMCA 210-99.

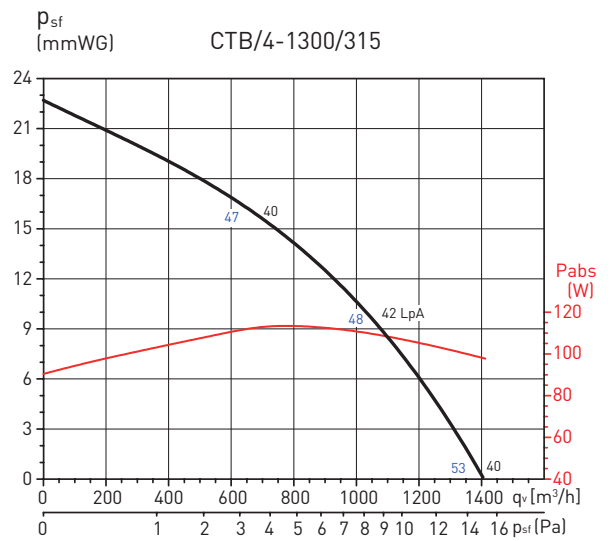
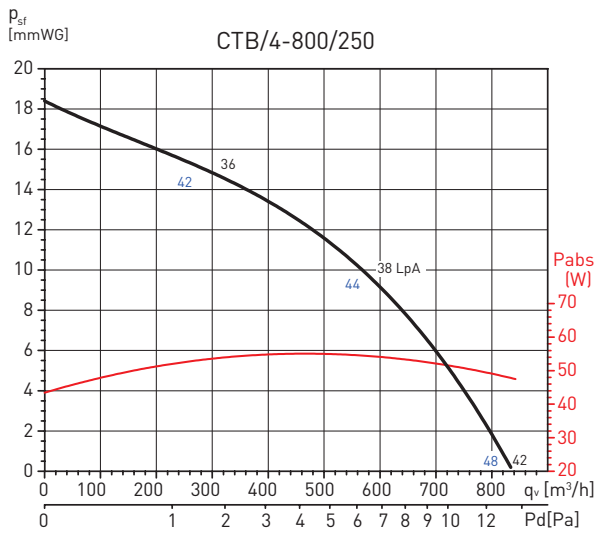
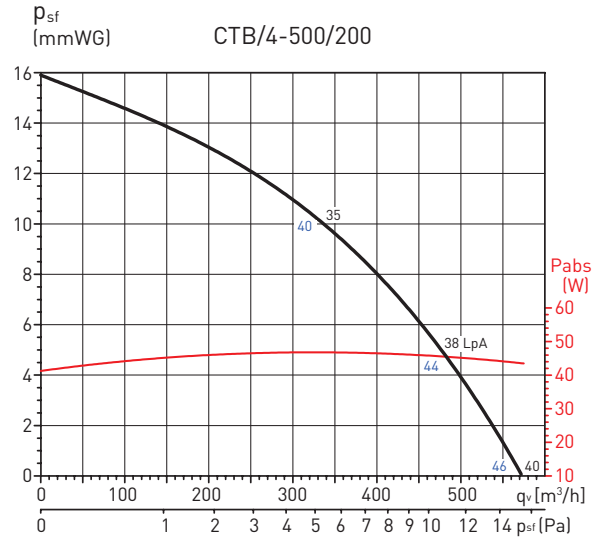
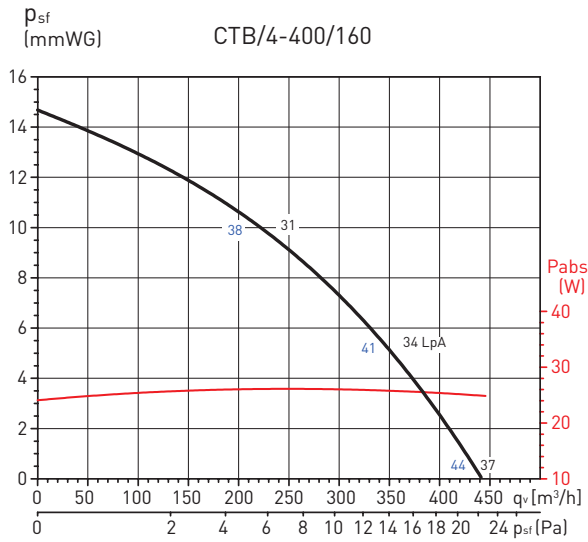

ELECTRICAL ACCESSORIES



REB
Single phase
electronic
speed controllers.