



Range of in-line fans for circular ducts, designed for high aerodynamic performances with a very compact profiles and very low sound levels.

Low profile compact casing manufactured from galvanised sheet steel. The terminal box and the mounting bracket do not increase the product's profile. Optimised design of the impeller, guide vane and outlet diffuser, manufactured from injection-moulded plastic, to increase performance and lower the sound level.

Airtight joint between the galvanised steel casing and the plastic guide vane to avoid air leaks. Rubber gaskets on the flanges to improve airtightness with the ducts. Silent-block between the motor and the holder to reduce the motor's vibrations and lower the sound level of the installation, even in terms of speed regulation.

The whole product is rated IP44 but its terminal box is rated IP65 allowing outdoor installation.

Motor

Fitted with an external rotor brushless EC motor:

- 230V ± 10% 50/60Hz, IP44.
- 100% speed controllable via internal potentiometer located in the terminal box or via 0-10V external signal.
- Ball bearings and thermal protection with manual reset.
- Working temperature: -20/40 °C



S&P certifies that the JETLINE ECOWATT shown herein are licensed to bear the AMCA Seal. The ratings shown are based on tests and procedures performed in accordance with AMCA Publication 211 and AMCA Publication 311 and comply with the requirements of the AMCA Certified Ratings Program

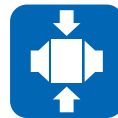

DESIGNED FOR AN EASY INSTALLATION



Terminal box

Built-in, IP65 terminal box that does not add to the overall height dimensions.



Airtight joints

Rubber gaskets for a more airtight joint with the installation's ducts.

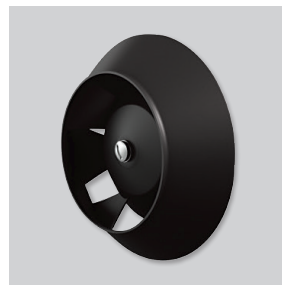

High performance Impeller

New impeller geometry for reduced sound levels and to offer high performance.

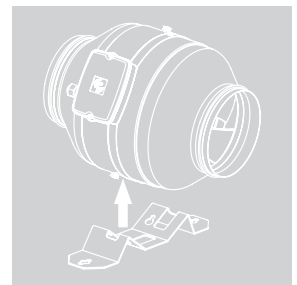

Mounting bracket

Strong mounting bracket supplied with the fan.

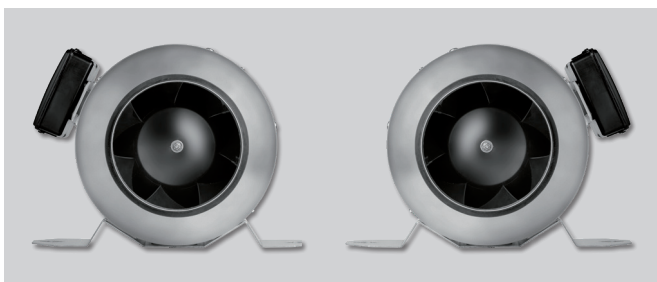

Two mounting positions for support

The product can be mounted in two different positions by changing the position of the support's anchoring.

TECHNICAL CHARACTERISTICS

Before installation check that the product electrical characteristics listed on the data plate label (voltage, power, frequency, etc.) match those of the intended electrical supply.

Model	Input tension regul. (V)	Speed (r.p.m.)	Maximum absorbed power (W)	Maximum absorbed current (A)	Maximum airflow (m ³ /h)	Sound pressure level* (dB(A))			Weight (kg)
						Inlet	Radiated	Outlet	
JETLINE-100 ECOWATT	10	2650	16	0,14	258	40	23	39	2,5
	8	2250	11	0,09	221	37	19	36	
	6	1750	7	0,07	176	31	14	30	
	4	1240	4	0,05	124	24	6	23	
JETLINE-125 ECOWATT	10	2650	26	0,21	393	46	25	46	2,8
	8	2240	17	0,15	330	42	21	43	
	6	1730	9	0,09	256	36	15	37	
	4	1230	5	0,06	192	29	8	30	
JETLINE-150 ECOWATT	10	2650	58	0,46	680	51	32	46	3,6
	8	2260	36	0,29	580	47	29	43	
	6	1740	18	0,16	450	41	37	37	
	4	1240	8	0,09	310	34	16	30	
JETLINE-160 ECOWATT	10	2650	60	0,47	720	50	31	49	3,6
	8	2250	38	0,29	610	47	28	45	
	6	1730	19	0,16	460	41	22	40	
	4	1240	8	0,08	330	33	15	32	
JETLINE-200 ECOWATT	10	2630	109	0,75	1050	59	40	56	4,7
	8	2250	70	0,52	890	55	37	53	
	6	1760	35	0,25	690	50	31	47	
	4	1250	15	0,14	490	42	24	40	
JETLINE-250 ECOWATT	10	2740	135	0,88	1270	57	43	57	5,8
	8	2350	96	0,67	1090	54	40	54	
	6	1830	49	0,35	820	48	35	49	
	4	1290	22	0,17	580	41	27	41	
JETLINE-315 ECOWATT	10	2640	194	1,28	1570	58	42	61	8
	8	2280	129	0,90	1360	55	39	57	
	6	1780	66	0,50	1070	49	33	52	
	4	1260	30	0,24	740	42	26	45	

*Sound pressure level measured at 1,5m in free field conditions, at the duty points 2 - 5 - 8 and 11 of the performance curve.

DIMENSIONS (mm)

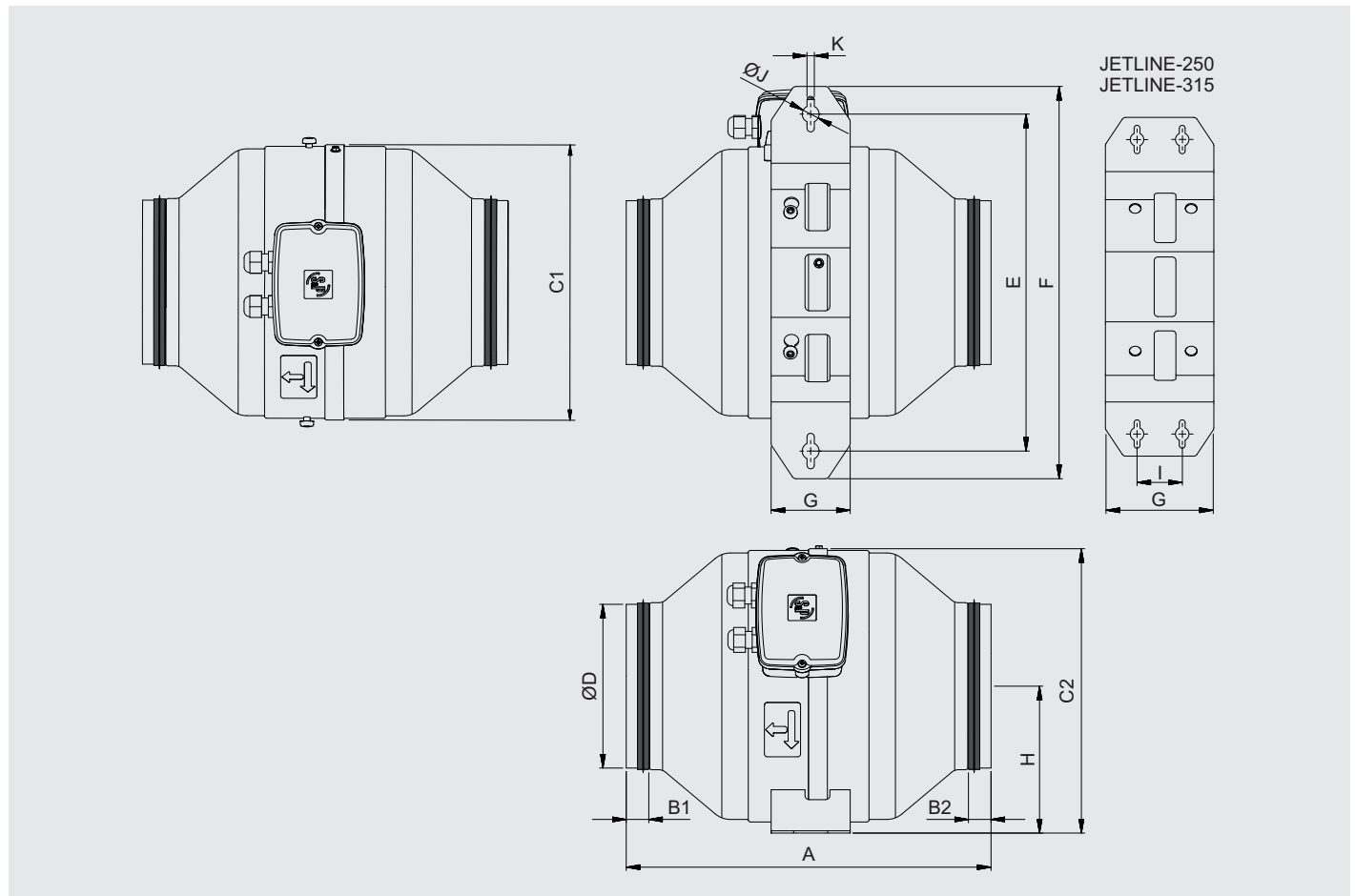

Model	A	B1	B2	C1	C2	D	E	F	G	H	I	J	K
JETLINE-100 ECOWATT	276	15	15	181	190	95	256	306	70	98	-	15	6,5
JETLINE-125 ECOWATT	279	15	15	206	214	120	265	315	70	111	-	15	6,5
JETLINE-150 ECOWATT	323	20	20	243,5	252	145	298,5	348	70	130	-	15	6,5
JETLINE-160 ECOWATT	323	20	20	243,5	252	155	298,5	348	70	130	-	15	6,5
JETLINE-200 ECOWATT	322	30	30	273	281	195	320	369	100	144,5	-	15	6,5
JETLINE-250 ECOWATT	329	20	30	293	301	245	326	375	120	154,3	50	15	6,5
JETLINE-315 ECOWATT	369	20	33	322	331	310	357,5	407	120	170	50	15	6,5

PERFORMANCE CURVES - ACOUSTIC CHARACTERISTICS

- q_v : Airflow in m^3/h .
- p_{st} : Static pressure in Pa.
- P: Input power in W.
- SFP: Specific fan power in $W/m^3/s$ (blue curves).
- Performance data in accordance with ISO 5801.

Air performance certified by AMCA is for installation type D – Ducted inlet, Ducted outlet.
Performance ratings do not include the effects of appurtenances (accessories).

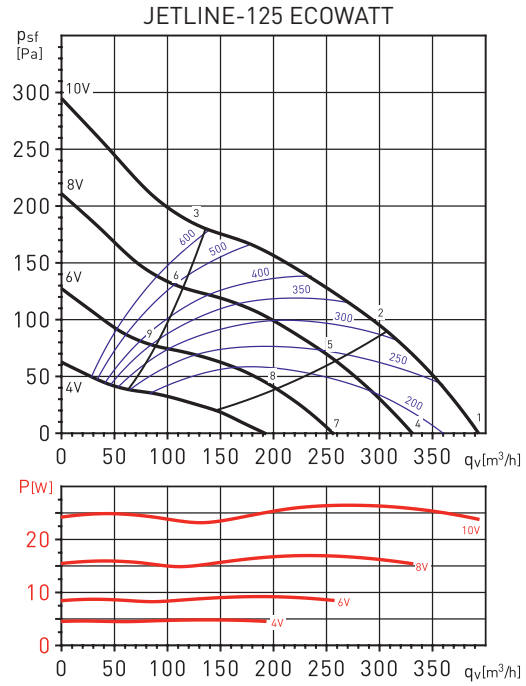
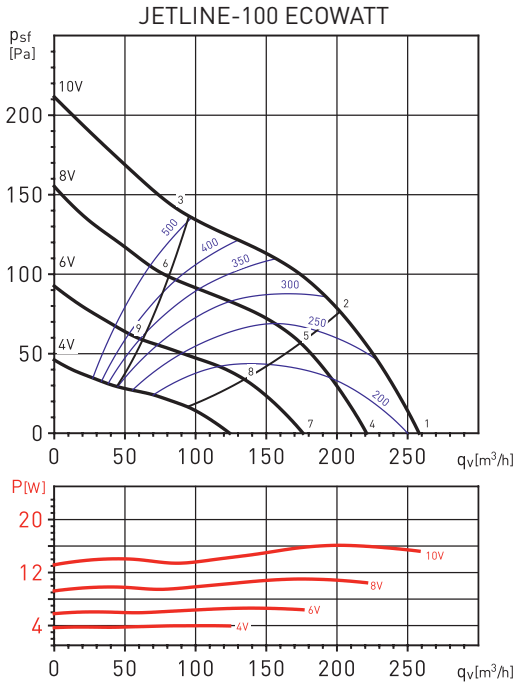

Sound data

Working point	1	2	3	4	5	6	7	8	9
LwIA	66	65	68	62	60	66	57	54	61

Sound performance certified by AMCA. Values shown are for inlet LwIA sound power levels for installation type D: ducted inlet, ducted outlet. Ratings include the effects of duct end correction.

The following sound data is a complementary data taken from S&P sound laboratory according ISO 13347-3, this data is not licensed by AMCA International.

Sound power spectrum (dB(A))

Working point	63	125	250	500	1000	2000	4000	8000	LwA
1 INLET	24	29	45	50	54	50	44	34	57
1 OUTLET	25	30	40	52	51	49	42	31	56
1 BREAK-OUT	23	19	31	28	34	32	30	20	39
2 INLET	26	29	44	48	52	48	43	33	55
2 OUTLET	25	31	39	50	49	46	40	30	54
2 BREAK-OUT	25	19	31	25	32	30	28	20	37
3 INLET	29	39	50	52	55	49	44	33	58
3 OUTLET	27	44	47	55	52	49	43	32	58
3 BREAK-OUT	28	29	37	29	35	32	30	20	41
4 INLET	21	26	41	47	50	47	41	30	53
4 OUTLET	22	27	37	49	47	45	39	28	52
4 BREAK-OUT	20	15	27	24	30	29	26	17	35
5 INLET	23	25	41	44	48	44	39	29	51
5 OUTLET	22	27	36	47	45	43	37	27	50
5 BREAK-OUT	21	15	27	21	28	27	25	16	34
6 INLET	25	36	47	49	51	46	41	30	55
6 OUTLET	24	40	44	51	49	45	39	29	55
6 BREAK-OUT	24	26	33	26	32	28	26	16	37
7 INLET	15	20	36	41	45	41	35	25	48
7 OUTLET	16	21	31	43	42	40	33	22	47
7 BREAK-OUT	14	10	22	19	25	23	21	11	30
8 INLET	17	20	35	39	42	39	34	24	46
8 OUTLET	16	22	30	41	40	37	31	21	45
8 BREAK-OUT	16	10	22	16	23	21	19	10	28
9 INLET	20	30	41	43	46	40	35	24	49
9 OUTLET	18	35	38	46	43	40	34	23	49
9 BREAK-OUT	19	20	28	20	26	23	21	11	32

Sound data

Working point	1	2	3	4	5	6	7	8	9
LwIA	70	67	78	67	64	68	61	58	63

Sound performance certified by AMCA. Values shown are for inlet LwIA sound power levels for installation type D: ducted inlet, ducted outlet. Ratings include the effects of duct end correction.

The following sound data is a complementary data taken from S&P sound laboratory according ISO 13347-3, this data is not licensed by AMCA International.

Sound power spectrum (dB(A))

Working point	63	125	250	500	1000	2000	4000	8000	LwA
1 INLET	27	35	50	61	54	56	53	42	63
1 OUTLET	29	43	56	58	57	58	50	40	64
1 BREAK-OUT	17	22	31	31	37	36	35	26	42
2 INLET	30	33	49	57	52	54	49	39	60
2 OUTLET	29	41	54	56	54	55	47	37	61
2 BREAK-OUT	20	20	30	27	34	34	31	23	39
3 INLET	34	47	57	62	57	56	51	41	65
3 OUTLET	36	51	59	59	58	56	49	39	65
3 BREAK-OUT	25	34	38	32	39	36	33	24	44
4 INLET	23	31	47	57	51	53	49	39	60
4 OUTLET	26	39	52	55	53	54	46	37	60
4 BREAK-OUT	14	18	28	28	33	33	31	22	38
5 INLET	26	30	45	53	48	50	46	35	57
5 OUTLET	25	38	50	52	51	51	43	33	57
5 BREAK-OUT	17	17	26	24	31	30	28	19	36
6 INLET	30	43	54	58	53	53	47	37	61
6 OUTLET	32	47	56	55	54	53	45	36	61
6 BREAK-OUT	21	30	35	29	36	32	29	21	41
7 INLET	17	26	41	51	45	47	44	33	54
7 OUTLET	20	33	46	49	48	49	41	31	54
7 BREAK-OUT	8	13	22	22	27	27	26	17	33
8 INLET	20	24	40	48	43	44	40	30	51
8 OUTLET	20	32	44	47	45	45	38	27	52
8 BREAK-OUT	11	11	21	18	25	24	22	13	30
9 INLET	25	38	48	52	48	47	42	32	56
9 OUTLET	27	41	50	50	49	47	40	30	55
9 BREAK-OUT	15	25	29	23	30	27	24	15	35

PERFORMANCE CURVES - ACOUSTIC CHARACTERISTICS

- q_v : Airflow in m^3/h .
- p_{sf} : Static pressure in Pa.
- P: Input power in W.
- SFP: Specific fan power in $W/m^3/s$ (blue curves).
- Performance data in accordance with ISO 5801.

Air performance certified by AMCA is for installation type D – Ducted inlet, Ducted outlet.
Performance ratings do not include the effects of appurtenances (accessories).

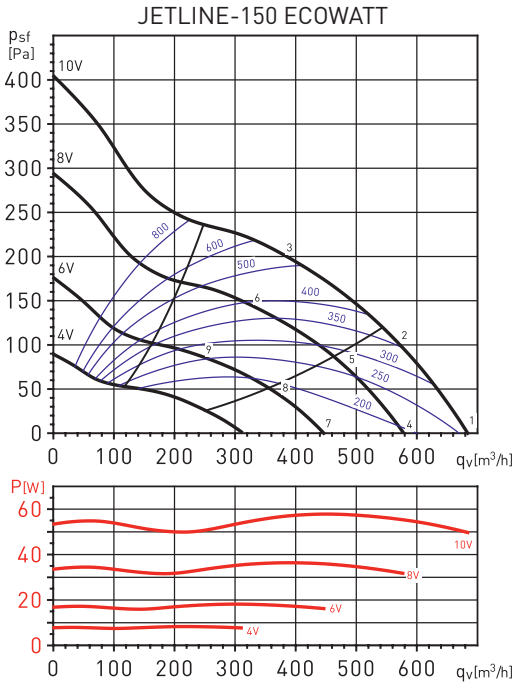

Sound data

Working point	1	2	3	4	5	6	7	8	9
LwiA	72	70	70	69	67	67	63	61	61

Sound performance certified by AMCA. Values shown are for inlet LwiA sound power levels for installation type D: ducted inlet, ducted outlet. Ratings include the effects of duct end correction.

The following sound data is a complementary data taken from S&P sound laboratory according ISO 13347-3, this data is not licensed by AMCA International.

Sound power spectrum (dB(A))

Working point		63	125	250	500	1000	2000	4000	8000	LwA
1	INLET	28	42	55	62	58	61	60	49	67
	OUTLET	43	44	57	62	57	58	56	47	66
	BREAK-OUT	20	32	37	39	42	42	46	36	49
2	INLET	26	42	54	61	56	59	56	48	65
	OUTLET	28	40	51	58	52	54	49	41	61
	BREAK-OUT	18	33	36	38	40	40	41	34	47
3	INLET	30	47	54	62	56	59	54	45	65
	OUTLET	31	47	56	62	57	58	51	44	65
	BREAK-OUT	22	38	36	38	40	40	39	32	47
4	INLET	24	39	51	59	55	57	57	46	64
	OUTLET	40	41	53	59	53	55	52	43	62
	BREAK-OUT	16	29	33	35	38	39	42	32	46
5	INLET	22	39	51	58	53	55	53	44	62
	OUTLET	25	36	48	54	49	50	46	38	57
	BREAK-OUT	14	29	32	34	36	37	38	30	43
6	INLET	26	44	51	58	53	56	50	42	62
	OUTLET	28	43	53	58	53	55	48	40	62
	BREAK-OUT	18	34	33	35	36	37	36	28	43
7	INLET	19	33	46	53	49	52	51	40	58
	OUTLET	34	35	48	53	48	49	47	38	57
	BREAK-OUT	11	23	27	30	33	33	37	27	40
8	INLET	17	33	45	52	47	50	47	38	56
	OUTLET	19	31	42	48	43	45	40	32	52
	BREAK-OUT	8	23	27	29	31	31	32	25	38
9	INLET	21	38	45	52	47	50	45	36	56
	OUTLET	22	38	47	53	48	49	42	35	56
	BREAK-OUT	13	29	27	29	30	31	30	22	38

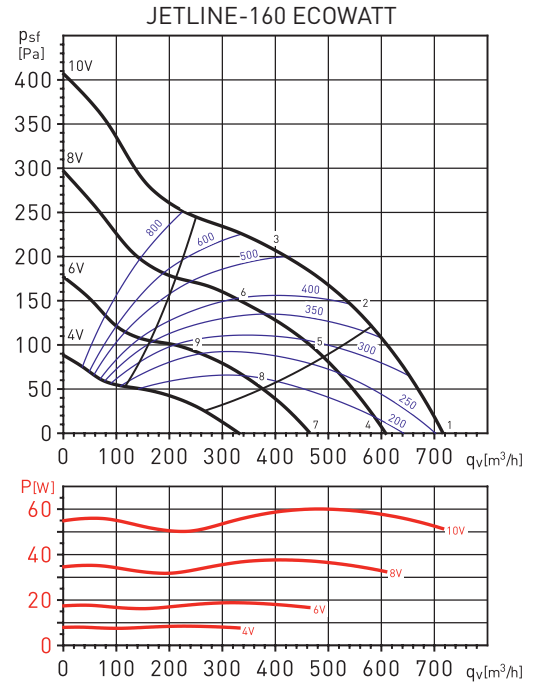

Sound data

Working point	1	2	3	4	5	6	7	8	9
LwiA	72	70	69	69	66	66	63	60	60

Sound performance certified by AMCA. Values shown are for inlet LwiA sound power levels for installation type D: ducted inlet, ducted outlet. Ratings include the effects of duct end correction.

The following sound data is a complementary data taken from S&P sound laboratory according ISO 13347-3, this data is not licensed by AMCA International.

Sound power spectrum (dB(A))

Working point		63	125	250	500	1000	2000	4000	8000	LwA
1	INLET	30	38	53	61	58	61	62	50	67
	OUTLET	30	40	55	60	57	59	59	48	65
	BREAK-OUT	20	24	31	34	37	40	48	34	49
2	INLET	28	37	53	59	55	59	58	47	65
	OUTLET	26	42	52	59	55	57	55	45	63
	BREAK-OUT	18	24	31	32	35	38	44	32	46
3	INLET	35	43	53	60	55	59	54	44	64
	OUTLET	32	47	54	61	57	58	52	43	65
	BREAK-OUT	24	30	31	33	34	38	40	29	44
4	INLET	27	34	49	58	54	57	59	46	64
	OUTLET	26	37	51	56	53	55	55	44	62
	BREAK-OUT	16	20	27	31	34	37	45	31	46
5	INLET	25	34	49	56	52	55	55	43	61
	OUTLET	22	39	49	55	52	54	51	42	60
	BREAK-OUT	14	20	27	29	31	35	40	28	42
6	INLET	31	40	50	57	52	55	51	40	61
	OUTLET	29	44	50	58	53	54	49	40	61
	BREAK-OUT	20	26	28	30	31	35	37	25	41
7	INLET	21	28	44	52	49	52	57	40	58
	OUTLET	20	31	45	51	48	49	50	39	56
	BREAK-OUT	11	15	22	25	28	31	39	25	40
8	INLET	19	28	44	50	46	50	49	38	55
	OUTLET	17	33	43	50	46	48	46	36	54
	BREAK-OUT	8	14	22	23	25	29	35	22	37
9	INLET	25	34	44	51	46	50	45	35	55
	OUTLET	23	38	45	52	48	49	43	34	55
	BREAK-OUT	15	21	22	24	25	29	31	20	35

PERFORMANCE CURVES - ACOUSTIC CHARACTERISTICS

- q_v : Airflow in m^3/h .
- p_{sf} : Static pressure in Pa.
- P: Input power in W.
- SFP: Specific fan power in $W/m^3/s$ (blue curves).
- Performance data in accordance with ISO 5801.

Air performance certified by AMCA is for installation type D – Ducted inlet, Ducted outlet.
Performance ratings do not include the effects of appurtenances (accessories).

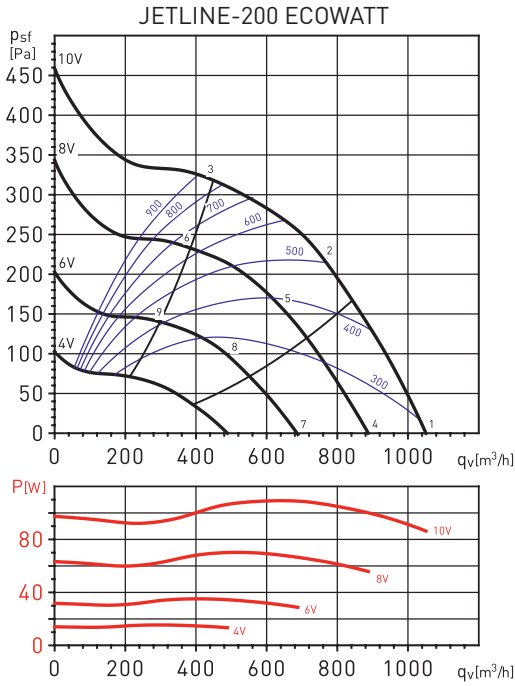

Sound data

Working point	1	2	3	4	5	6	7	8	9
LwiA	76	77	78	73	74	74	67	68	69

Sound performance certified by AMCA. Values shown are for inlet LwiA sound power levels for installation type D: ducted inlet, ducted outlet. Ratings include the effects of duct end correction.

The following sound data is a complementary data taken from S&P sound laboratory according ISO 13347-3, this data is not licensed by AMCA International.

Sound power spectrum (dB(A))

Working point		63	125	250	500	1000	2000	4000	8000	LwA
1	INLET	30	43	59	64	67	65	65	60	72
	OUTLET	33	43	60	65	64	64	61	54	71
	BREAK-OUT	18	35	42	43	48	48	48	42	54
2	INLET	31	41	57	67	69	66	63	57	73
	OUTLET	30	44	56	64	66	65	59	52	70
	BREAK-OUT	19	32	40	45	51	49	45	39	54
3	INLET	39	50	62	67	70	68	61	53	74
	OUTLET	38	52	61	65	67	68	59	49	72
	BREAK-OUT	27	41	45	45	51	51	44	35	56
4	INLET	27	40	56	61	63	61	62	56	69
	OUTLET	29	40	57	62	61	61	58	51	67
	BREAK-OUT	15	32	38	39	45	44	44	39	50
5	INLET	27	38	54	64	66	62	60	54	70
	OUTLET	27	41	52	61	63	61	56	49	67
	BREAK-OUT	15	29	36	42	47	45	42	36	51
6	INLET	36	46	59	63	67	65	58	49	70
	OUTLET	34	48	58	61	64	64	56	46	69
	BREAK-OUT	24	38	41	42	48	48	40	32	52
7	INLET	21	35	50	56	58	56	57	51	63
	OUTLET	24	34	51	57	55	55	53	45	62
	BREAK-OUT	9	26	33	34	39	39	39	33	45
8	INLET	22	32	48	58	61	57	54	48	64
	OUTLET	21	36	47	56	57	56	50	43	62
	BREAK-OUT	10	24	31	37	42	40	36	31	46
9	INLET	30	41	53	58	61	59	53	44	65
	OUTLET	29	43	53	56	58	59	50	41	63
	BREAK-OUT	18	32	36	36	42	42	35	26	47

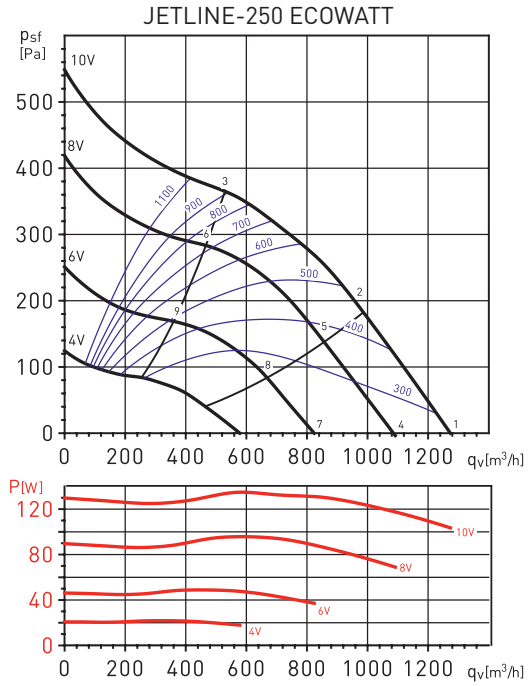

Sound data

Working point	1	2	3	4	5	6	7	8	9
LwiA	76	74	77	73	71	74	68	66	68

Sound performance certified by AMCA. Values shown are for inlet LwiA sound power levels for installation type D: ducted inlet, ducted outlet. Ratings include the effects of duct end correction.

The following sound data is a complementary data taken from S&P sound laboratory according ISO 13347-3, this data is not licensed by AMCA International.

Sound power spectrum (dB(A))

Working point		63	125	250	500	1000	2000	4000	8000	LwA
1	INLET	38	47	64	64	67	67	64	65	73
	OUTLET	35	46	65	65	69	70	64	61	75
	BREAK-OUT	23	32	45	45	55	56	48	43	59
2	INLET	39	43	61	63	67	65	61	60	71
	OUTLET	39	47	62	62	67	67	58	56	72
	BREAK-OUT	24	28	42	44	55	54	45	38	58
3	INLET	44	53	65	66	69	68	62	55	74
	OUTLET	46	57	65	66	70	71	59	51	75
	BREAK-OUT	29	38	46	47	56	57	46	33	60
4	INLET	35	43	60	61	64	64	60	62	70
	OUTLET	32	42	62	62	66	67	61	58	71
	BREAK-OUT	20	29	41	42	51	52	45	40	56
5	INLET	36	40	57	60	64	62	58	57	68
	OUTLET	36	44	59	59	64	64	55	53	69
	BREAK-OUT	21	25	39	41	51	51	42	35	55
6	INLET	41	50	62	63	66	65	59	52	71
	OUTLET	43	55	62	63	67	68	56	48	72
	BREAK-OUT	26	36	43	44	54	54	44	30	57
7	INLET	29	38	55	55	58	59	55	57	65
	OUTLET	27	37	57	57	60	61	56	53	66
	BREAK-OUT	15	24	36	36	46	47	40	35	50
8	INLET	30	34	52	55	59	57	52	51	63
	OUTLET	30	38	54	54	58	59	49	48	63
	BREAK-OUT	16	20	33	36	46	45	37	29	49
9	INLET	35	45	56	58	61	60	54	47	65
	OUTLET	38	49	57	57	61	63	51	43	67
	BREAK-OUT	21	30	38	38	48	48	38	24	52

PERFORMANCE CURVES - ACOUSTIC CHARACTERISTICS

- q_v : Airflow in m^3/h .
- p_{sf} : Static pressure in Pa.
- P: Input power in W.
- SFP: Specific fan power in $W/m^3/s$ (blue curves).
- Performance data in accordance with ISO 5801.

Air performance certified by AMCA is for installation type D – Ducted inlet, Ducted outlet.
 Performance ratings do not include the effects of appurtenances (accessories).

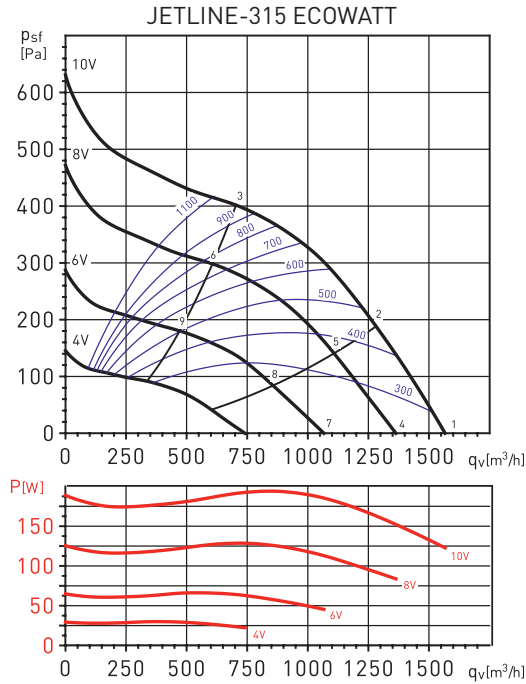

Sound data

Working point	1	2	3	4	5	6	7	8	9
LwiA	77	75	79	74	72	75	68	67	70

Sound performance certified by AMCA. Values shown are for inlet LwiA sound power levels for installation type D: ducted inlet, ducted outlet. Ratings include the effects of duct end correction.

The following sound data is a complementary data taken from S&P sound laboratory according ISO 13347-3, this data is not licensed by AMCA International.

Sound power spectrum (dB(A))

Working point	63	125	250	500	1000	2000	4000	8000	LwA
1 INLET	33	55	66	64	66	67	67	67	74
1 OUTLET	32	50	65	69	73	72	69	63	77
1 BREAK-OUT	13	45	54	48	50	51	49	45	58
2 INLET	32	50	63	65	66	65	62	64	72
2 OUTLET	33	50	64	67	71	70	63	61	75
2 BREAK-OUT	13	41	51	49	50	49	45	42	56
3 INLET	45	59	69	68	70	69	63	58	76
3 OUTLET	46	57	69	69	75	74	63	55	79
3 BREAK-OUT	26	49	57	52	54	53	46	36	61
4 INLET	30	52	62	61	63	64	64	63	71
4 OUTLET	29	47	62	65	69	69	66	60	74
4 BREAK-OUT	10	42	51	45	47	48	46	42	55
5 INLET	29	47	60	62	63	62	59	60	69
5 OUTLET	30	47	61	64	68	67	59	58	72
5 BREAK-OUT	10	38	48	46	47	46	41	39	53
6 INLET	42	56	66	65	67	66	60	55	72
6 OUTLET	43	54	65	66	72	71	60	52	76
6 BREAK-OUT	23	46	54	49	51	49	43	33	58
7 INLET	24	46	57	55	58	58	58	58	65
7 OUTLET	24	42	57	60	64	64	60	55	69
7 BREAK-OUT	5	37	45	39	41	42	41	36	50
8 INLET	24	42	54	57	57	57	53	55	64
8 OUTLET	24	41	55	58	62	61	54	52	66
8 BREAK-OUT	5	33	43	40	41	40	36	33	48
9 INLET	37	50	60	59	62	60	55	49	67
9 OUTLET	38	49	60	61	66	66	54	47	70
9 BREAK-OUT	17	41	48	43	45	44	37	28	52