

■ Specification for all models

□ Casing

Manufactured in galvanised sheet steel. Model HQ and HW have an additional two-layer finishing in papyrus white, Ex-models without paint.

□ Impeller

Highly efficient, profiled blade impeller, dynamically balanced and manufactured from impact resistant polymers. Suitable for -30 to +60 °C. Deviation for ex-models.

□ Motor

Totally enclosed motor with a die-cast aluminium casing, protected to IP 55 or IP 54. Ball bearing mounted. Maintenance-free and interference-free. Humidity protection of windings. For maximum air flow temperature see table below. Deviation for ex-models.

□ Motor protection

All models (3~ explosion proof excluded) have thermal contacts as standard which must be connected to a motor protection unit (see below). The models H..W 250/6, H..W 250/4 and all 1 ph. ex-proof fans have automatic resetting thermal contacts wired in series with the motor windings.

□ Electrical connection

Terminal box (IP 54/55) mounted on rear of motor as standard. Also on outside of piping for HRF. Deviation for ex-models.

□ Guard

Powder-coated steel wire for HQ and HW (HQ ex-models galvanised) according to DIN EN ISO 13857.

□ Speed control

For all speed controllable models the current are identified with a value in the "speed controlled" column of the table below which must be used when selecting a controller. Possible allocations of frequency inverters are specified in the table below. The planned use of a frequency inverter without Sine filter must be stated when ordering. This requires a change of fan design and potential additional costs. The air flow rates are shown in the performance curves.

□ Reversed operation

All models are reversible when wired to a reversing switch. For reverse air flow direction allow a loss in performance of approx. 1/3.

□ Installation

Installation in any position. Ensure that the motor drainage holes face downwards.

□ Dimensions

Pole-switch and explosion proof models may deviate from the information above.

□ Sound levels

See characteristic curve. The sound power and sound pressure are specified at 4 m distances under free field conditions, for average operating point suction/pressure side. See page 10 on for sound emission and acoustics. Deviation for ex-models.

Information	Page
Techn. description	140
Selection chart	141
Information for planning	10 on

R.P.M.	Air flow volume (FID)	Motor power	Current*		Wiring diagram	max. air flow temp. speed controlled		Weight net	Model							
			standard-supply	max. controlled		standard supply	temp. controlled		HQ incl. guard	Ref. no.	HW incl. guard	Ref. no.	HS incl. guard	Ref. no.	HRF	Ref. no.
min ⁻¹	∇ m ³ /h	W	A	A	No.	+°C	+°C	kg								
1 Phase motor, 230 Volt / 50 Hz, capacitor motor, protection to IP 54/IP 55																
930	660	35	0.20	0.22	317	60	40	6.5	HQW 250/6	1102	—	—	HSW 250/6	0139	—	—
1300	930	36	0.15	0.15	439 ²⁾	60	40	7.5	HQW 250/4 ¹⁾	1103	HWW 250/4 ¹⁾	1001	HSW 250/4 ¹⁾	0140	HRFW 250/4 ¹⁾²⁾	0200
2710	2070	187	0.81	0.9	317 ³⁾	60	40	6.5	HQW 250/2	1104	HWW 250/2	1002	HSW 250/2	0141	HRFW 250/2 ³⁾	0201
3 Phase motor, 400 Volt / 50 Hz, squirrel cage motor protection to IP 55																
980	700	61	0.27	0.33	469	60	40	6.5	HQD 250/6	1114	—	—	—	—	—	—
1390	950	55	0.15	0.15	469	60	40	6.5	HQD 250/4 ¹⁾	1115	HWD 250/4 ¹⁾	1016	HSD 250/4 ¹⁾	0155	HRFD 250/4 ¹⁾	0220
2550	2000	169	0.31	0.33	469	60	40	6.5	HQD 250/2	1116	HWD 250/2	1017	—	—	HRFD 250/2	0221
2 speed motor, pole-switching, Dahlander windings, 400 Volt, 50 Hz, protection to IP 55																
1430/2770	1030/2110	58/212	0.16/0.43	—	472	60	—	8.5	HQD 250/4/2	1128	—	—	—	—	HRFD 250/4/2	0390
Explosion proof Ex d II B, 1 ph., 230 Volt, 50 Hz, protection to IP 55, temp. class T1-T3																
1400	1030	60*	0.70*	—	757	40	—	12	HQW 250/4 Ex	0438	—	—	—	—	HRFW 250/4 Ex	0437
2690	1950	180*	1.23*	—	757	40	—	13	HQW 250/2 Ex	1094	—	—	—	—	HRFW 250/2 Ex	1095
Explosion proof Ex e II, 3 ph., 400 Volt, 50 Hz, protection to IP 55, temp. class T1-T3																
1350	1070	120*	0.37*	—	470	40	—	12	HQD 250/4 Ex	1144	—	—	—	—	HRFD 250/4 Ex	0470
2800	2070	250*	0.75*	—	470	40	—	11	HQD 250/2 Ex	1145	—	—	—	—	HRFD 250/2 Ex	0471

* Motor nominal values, Ex see info page 16.

¹⁾ Special design not possible. ²⁾ Type HRFW: connect using wiring diagram no. SS-962. ³⁾ Type HRFW./2: connect using wiring diagram no. SS-963.

250/2

Frequency	Hz	Total	125	250	500	1k	2k	4k	8k	
LWA	Air noise	dB(A)	75	38	53	66	68	70	69	62
LPA _{4m}	Air noise	dB(A)	55	18	33	46	48	49	48	42

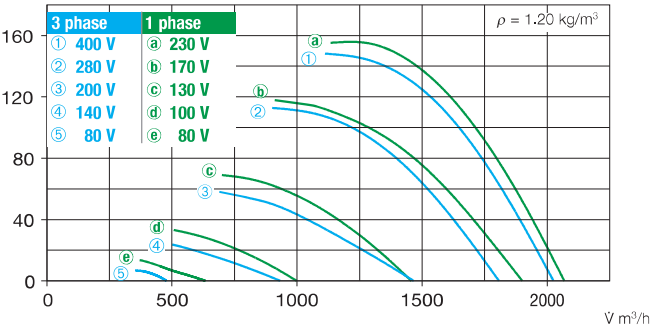

250/4 Three phase

Frequency	Hz	Total	125	250	500	1k	2k	4k	8k	
LWA	Air noise	dB(A)	64	50	54	61	57	55	50	41
LPA _{4m}	Air noise	dB(A)	44	30	34	41	37	35	30	21

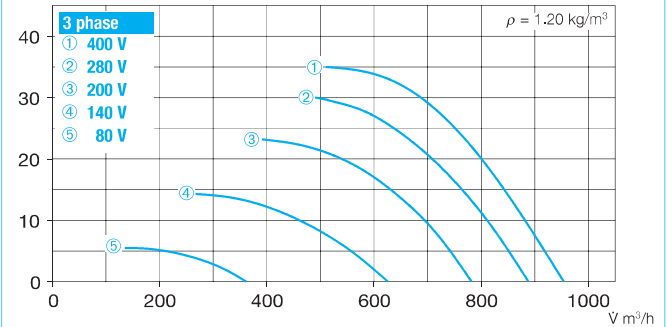

250/4 Single phase

Frequency	Hz	Total	125	250	500	1k	2k	4k	8k
LWA	Air noise	dB(A)	55	37	43	47	49	46	38
LPA _{4m}	Air noise	dB(A)	35	17	23	27	29	26	18

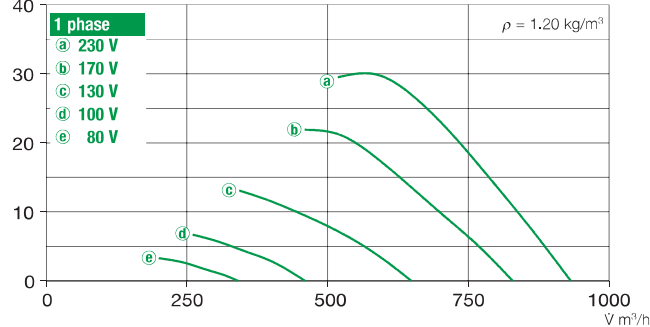

250/6

Frequency	Hz	Total	125	250	500	1k	2k	4k	8k	
LWA	Air noise	dB(A)	53	40	47	47	46	43	37	30
LPA _{4m}	Air noise	dB(A)	33	20	27	27	26	23	17	10

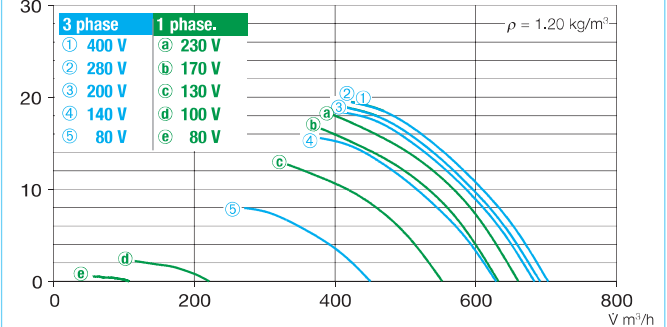

Accessories for HRF Description see page 230 on

Bell mount with guard ASD-SGD 250 No. 1414
Extension duct VR 250 No. 1402
Circular attenuator RSD 250/..
Automatic back-draught shutter RVS 250 a) No. 2592
Flang. flex. connector STS 250 b) No. 1220
Counter flange FR 250 No. 1203
Flat flange FF 250 No. 4941
Flexible sleeve FM 250 b) No. 1672
Guard SG 250 Nr. 1236
2 mounting feet 1 x MK 250 (= 2 pcs.) No. 1447
4 vibration dampers for suspension 1 x SDZ 1 (= 4 pcs.) No. 1454
4 vibration dampers for compression 1 x SDD 1 (= 4 pcs.) No. 1452

a) For motorised shutters see accessory page

b) Models for ex-proof fans see below

Frequency inverter with integrated Sine filter	Transformer controller 5-speed Pole switch	Electronic controller, stepless flush/surf.	Full motor protection for connection of integrated thermal contacts	Reversing switch			
Model	Ref. no.	Model	Ref. no.	Model	Ref. no.		
—	—	TSW 0,3	3608	ESU 1/ESA 1	0236/0238	WS	1271
—	—	TSW 0,3	3608	ESU 1/ESA 1	0236/0238	DSEL 2	1306
—	—	MWS 1,5	1947	ESU 3/ESA 3	0237/0239	MW	1579
FU-BS 2,5 ⁴⁾	5459	RDS 1 ⁴⁾	1314	—	—	MD	5849
FU-BS 2,5 ⁴⁾	5459	RDS 1 ⁴⁾	1314	—	—	MD	5849
FU-BS 2,5 ⁴⁾	5459	RDS 1 ⁴⁾	1314	—	—	MD	5849
—	—	Pole switch	—	—	—	—	—
—	—	PDA 12 ⁶⁾	5081	—	—	M 3 ⁵⁾	1293
—	—	—	—	—	—	PWDA	1282
—	—	not permitted	not permitted	—	—	—	—
—	—	not permitted	not permitted	—	—	—	—
—	—	not permitted	not permitted	—	—	—	—
—	—	not permitted	not permitted	—	—	—	—

⁴⁾ Incl. full motor protection.

⁵⁾ Incl. pole switch.

⁶⁾ See switch product page for flush mounted version

Other accessories Page

b) Accessories for explosion proof fans
Flanged flexible connector Type STS 250 Ex Ref. no. 2501
Flexible sleeve Type FM 250 Ex Ref. no. 1688

Extension tube for HS Type VH 250 Ref. no. 1343
 Cylindrical duct, galvanised steel, length: 150 mm.

Attenuators 421 on
 Shutters and grilles 487 on
 Speed controllers and switches 525 on

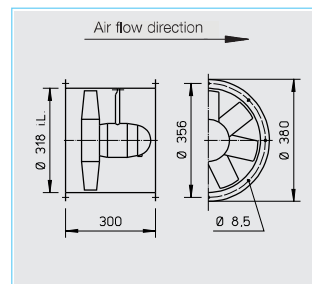
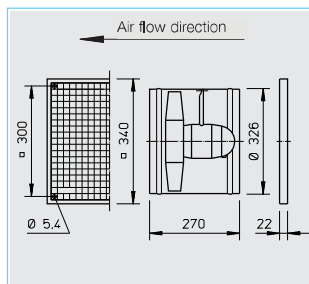
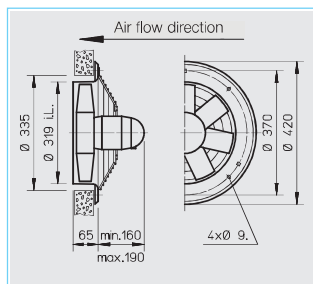
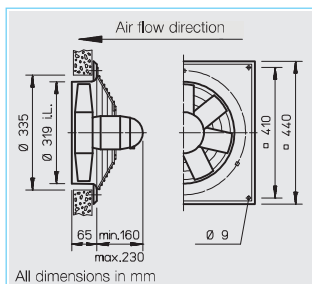

■ Specification for all models

- Casing**
Manufactured in galvanised sheet steel. Model HQ and HW have an additional two-layer finishing in papyrus white. Ex-models without paint.
- Impeller**
Highly efficient, profiled blade impeller, dynamically balanced and manufactured from impact resistant polymers. Suitable for -30 to +60 °C. Deviation for ex-models.
- Motor**
Totally enclosed motor with a die-cast aluminium casing, protected to IP 55. Ball bearing mounted. Maintenance-free and interference-free. Humidity protection of windings. For maximum air flow temp. see table below. Deviation for ex-models.

- Motor protection**
All models (3~ explosion proof excluded) have thermal contacts as standard which must be connected to a motor protection unit (see below). The models H.W 315/6 and all 1 ph. ex-proof fans have automatic resetting thermal contacts wired in series with the motor windings.
- Electrical connection**
Terminal box (IP 55) mounted on rear of motor as standard. Also on outside of piping for HRF. Deviation for ex-models.
- Guard**
Powder-coated steel wire for HQ and HW (HQ ex-models galvanised), polymer for HS according to DIN EN ISO 13857.

- Speed control**
For all speed controllable models the current are identified with a value in the "speed controlled" column of the table below which must be used when selecting a controller. Possible allocations of frequency inverters are specified in the table below. The planned use of a frequency inverter without Sine filter must be stated when ordering. This requires a change of fan design and potential additional costs. The air flow rates are shown in the performance curves.
- Reversed operation**
All models are reversible when wired to a reversing switch. For reverse air flow direction allow a loss in performance of approx. 1/3.

- Installation**
Installation in any position. Ensure that the motor drainage holes face downwards.
- Dimensions**
Pole-switch and explosion proof models may deviate from the information above.
- Sound levels**
See characteristic curve. The sound power and sound pressure are specified at 4 m distances under free field conditions, for average operating point suction/pressure side. See page 10 on for sound emission and acoustics. Deviation for ex-models.

R.P.M.	Air flow volume (FID)	Motor power	Current*		Wiring diagram	max. air flow temp.		Weight net	Model							
			standard-supply	max. controlled		standard supply	speed controlled		Ø 319 I.L.	Ref. no.	Ø 319 I.L.	Ref. no.	Ø 318 I.L.	Ref. no.	Ø 318 I.L.	Ref. no.
min ⁻¹	∇ m ³ /h	W	A	A	No.	+°C	+°C	kg	HQ incl. guard	Ref. no.	HW incl. guard	Ref. no.	HS incl. guard	Ref. no.	HRF	Ref. no.
1 Phase motor, 230 Volt / 50 Hz, capacitor motor, protection to IP 55																
920	1330	33	0.25	0.35	317 ¹⁾	60	40	9.0	HQW 315/6	1105	—	—	HSW 315/6	0142	HRFW 315/6 ¹⁾	0202
1390	2080	104	0.45	0.47	475 ²⁾	60	40	8.0	HQW 315/4	1106	HWW 315/4	1004	HSW 315/4	0143	HRFW 315/4 ²⁾	0203
3 Phase motor, 400 Volt / 50 Hz, squirrel cage motor protection to IP 55																
950	1370	68	0.27	0.32	469	60	40	9.0	HQD 315/6	1117	—	—	—	—	—	—
1330	1960	84	0.24	0.26	469	60	40	9.0	HQD 315/4	1118	HWD 315/4	1019	HSD 315/4	0158	HRFD 315/4	0223
2760	4080	527	1.10	1.23	469	50	40	11.0	HQD 315/2	1119	HWD 315/2	1020	—	—	HRFD 315/2	0224
Two-speed, 3 ph., 400 V, 50 Hz, Y/Δ switch, protection to IP 55																
1040/1280	1530/1980	56/87	0.11/0.22	—	520	60	—	10.5	HQD 315/4/4	1460	—	—	—	—	HRFD 315/4/4	1462
2 speed motor, pole-switching, Dahlander windings, 400 Volt, 50 Hz, protection to IP 55																
720/1445	980/2060	49/115	0.20/0.43	—	472	60	—	12.0	HQD 315/8/4	1129	—	—	HSD 315/8/4	0346	HRFD 315/8/4	0391
1445/2845	2100/4190	106/558	0.45/1.32	—	472	50	—	12.5	HQD 315/4/2	1131	—	—	HSD 315/4/2	0348	HRFD 315/4/2	0393
Explosion proof Ex d II B, 1 ph., 230 Volt, 50 Hz, protection to IP 55, temp. class T1-T3																
1370	2070	180*	1.25*	—	757	40	—	13.0	HQW 315/4 Ex	0442	—	—	—	—	HRFW 315/4 Ex	0439
Explosion proof Ex e II, 3 ph., 400 Volt, 50 Hz, protection to IP 55, temp. class T1-T3																
920	1400	250*	0.97*	—	470	40	—	23.0	HQD 315/6 Ex	1098	—	—	—	—	—	—
1350	2140	120*	0.37*	—	470	40	—	14.0	HQD 315/4 Ex	1147	—	—	—	—	HRFD 315/4 Ex	0473
2770	4130	550*	1.43*	—	470	40	—	16.5	HQD 315/2 Ex	1148	—	—	—	—	HRFD 315/2 Ex	0474

* Motor nominal values, Ex see info page 16. ¹⁾ Type HRFW./6: connect using wiring diagram no. SS-963. ²⁾ Type HRFW./4: connect using wiring diagram no. SS-965. ³⁾ Incl. full motor protection.

315/2

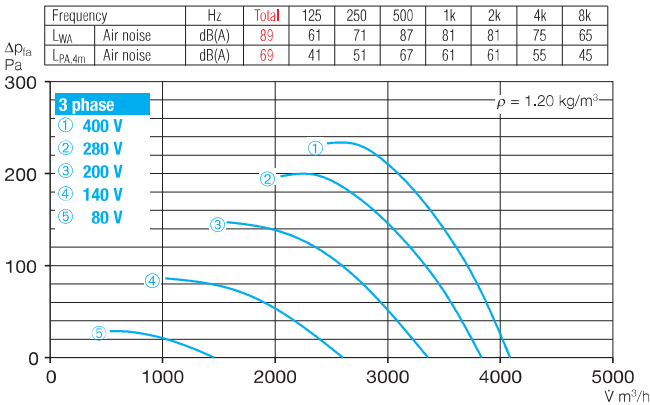

315/4

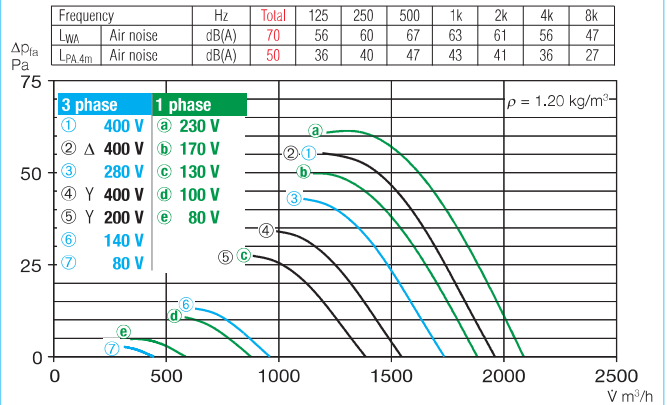

315/6

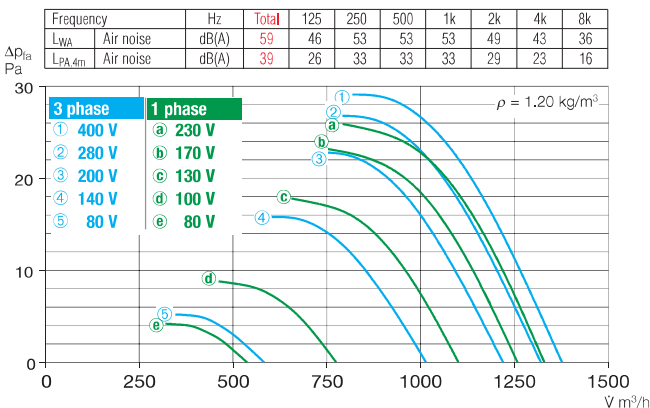

315/8

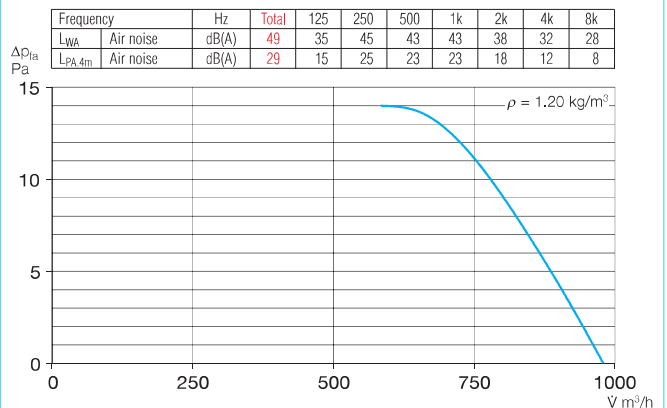

Accessories for HRF Description see page 230 on

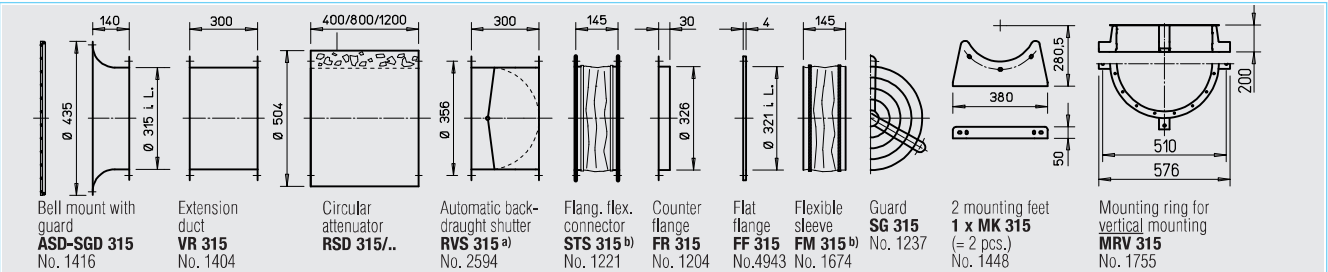

^{a)} For motorised shutters see accessory page

^{b)} Models for ex-proof fans see below

Frequency inverter with integrated Sine filter		Transformer controller 5-speed Pole switch		Electronic controller, stepless flush/surf.		Full motor protection for connection of integrated thermal contacts		Reversing switch	
Model	Ref. no.	Model	Ref. no.	Model	Ref. no.	Model	Ref. no.	Model	Ref. no.
—	—	TSW 0,3	3608	ESU 1/ESA 1	0236/0238	—	—	WS	1271
—	—	MWS 1,5 ³⁾	1947	ESU 1/ESA 1	0236/0238	MW	1579	WS	1271
FU-BS 2,5 ³⁾	5459	RDS 1 ³⁾	1314	—	—	MD	5849	WS	1271
FU-BS 2,5 ³⁾	5459	RDS 1 ³⁾	1314	—	—	MD	5849	WS	1271
FU-BS 2,5 ³⁾	5459	RDS 2 ³⁾	1315	ESD 5	0501	MD	5849	WS	1271
Speed switch									
FU-BS 2,5 ³⁾	5459	DS2	1351	—	—	M 4 ⁴⁾ /MD	1571/5849	WS	1271
Pole switch									
—	—	PDA 12 ⁵⁾	5081	—	—	M 3 ⁴⁾	1293	PWDA	1282
—	—	PDA 12 ⁵⁾	5081	—	—	M 3 ⁴⁾	1293	PWDA	1282
—	—	not permitted	not permitted	not permitted	not permitted	—	—	—	—
—	—	not permitted	not permitted	not permitted	not permitted	—	—	—	—
—	—	not permitted	not permitted	not permitted	not permitted	—	—	—	—
—	—	not permitted	not permitted	not permitted	not permitted	—	—	—	—

⁴⁾ Incl. pole switch.

⁵⁾ See switch product page for flush mounted version.

Other accessories Page

^{b)} Accessories for explosion proof fans
Flanged flexible connector
 Type STS 315 Ex Ref. no. 2503
Flexible sleeve
 Type FM 315 Ex Ref. no. 1690

Extension tube for HS
 Type VH 315 Ref. no. 1344
 Cylindrical duct, galvanised steel, length: 150 mm.

Attenuators 421 on
 Shutters and grilles 487 on
 Speed controllers and switches 525 on

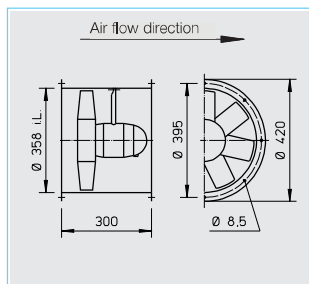
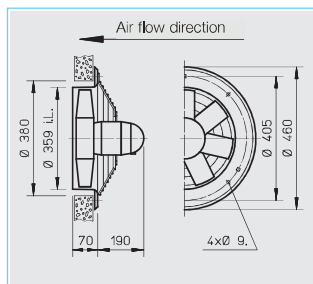
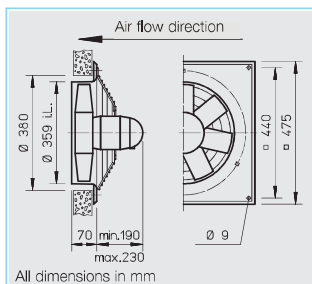

■ Specification for all models

□ Casing

Manufactured in galvanised sheet steel. Model HQ and HW have an additional two-layer finishing in papyrus white, Ex-models without paint.

□ Impeller

Highly efficient, profiled blade impeller, dynamically balanced and manufactured from impact resistant polymers. Suitable for -30 to +60 °C. Deviation for ex-models.

□ Motor

Totally enclosed motor with a die-cast aluminium casing, protected to IP 55. Ball bearing mounted. Maintenance-free and interference-free. Humidity protection of windings. For maximum air flow temp. see table below. Deviation for ex-models.

□ Motor protection

All models (3~ explosion proof excluded) have thermal contacts as standard which must be connected to a motor protection unit (see below). 1 ph, ex-proof fans have automatic resetting thermal contacts wired in series with the motor windings.

□ Electrical connection

Terminal box (IP 55) mounted on rear of motor as standard. Also on outside of piping for HRF. Deviation for ex-models.

□ Guard

Powder-coated steel wire for HQ and HW (HQ ex-models galvanised) according to DIN EN ISO 13857.

□ Speed control

For all speed controllable models the current are identified with a value in the "speed controlled" column of the table below which must be used when selecting a controller. Possible allocations of frequency inverters are specified in the table below. The planned use of a frequency inverter without Sine filter must be stated when ordering. This requires a change of fan design and potential additional costs. The air flow rates are shown in the performance curves.

□ Reversed operation

All models are reversible when wired to a reversing switch. For reverse air flow direction allow a loss in performance of approx. 1/3.

□ Installation

Installation in any position. Ensure that the motor drainage holes face downwards.

□ Dimensions

Pole-switch and explosion proof models may deviate from the information above.

□ Sound levels

See characteristic curve. The sound power and sound pressure are specified at 4 m distances under free field conditions, for average operating point suction/pressure side. See page 10 on for sound emission and acoustics. Deviation for ex-models.

R.P.M.	Air flow volume (FID)	Motor power	Current*		Wiring diagram	max. air flow temp.		Weight net	Model							
			standard-supply	max. controlled		standard supply	speed controlled		HQ incl. guard	Ref. no.	HW incl. guard	Ref. no.	HRF	Ref. no.		
min ⁻¹	∇ m ³ /h	W	A	A	No.	+°C	+°C	kg								
1 Phase motor, 230 Volt / 50 Hz, capacitor motor, protection to IP 55																
960	1940	75	0.47	0.47	475 ¹⁾	60	40	12	HQW 355/6	1107	—	—	HRFW 355/6¹⁾	0204		
1345	2850	130	0.60	0.65	475 ¹⁾	60	40	11	HQW 355/4	1108	HWW 355/4	1006	HRFW 355/4¹⁾	0205		
3 Phase motor, 400 Volt / 50 Hz, squirrel cage motor protection to IP 55																
960	1970	70	0.27	0.29	469	60	40	9.5	HQD 355/6	1120	—	—	—	—		
1375	2900	130	0.35	0.35	469	60	40	11.0	HQD 355/4	1121	HWD 355/4	1022	HRFD 355/4	0226		
2670	5710	825	1.60	1.60	469	60	40	15.0	HQD 355/2	1122	HWD 355/2	1023	HRFD 355/2	0227		
Two-speed, 3 ph., 400 V, 50 Hz, Y/Δ switch, protection to IP 55																
1120/1350	2460/2860	90/132	0.17/0.32		520	60	—	11.0	HQD 355/4/4	1463	—	—	HRFD 355/4/4	1464		
2 speed motor, pole-switching, Dahlander windings, 400 Volt, 50 Hz, protection to IP 55																
700/1395	1430/2920	45/145	0.14/0.35		472	60	—	11.0	HQD 355/8/4	1132	—	—	HRFD 355/8/4	0394		
1430/2840	3050/6150	250/950*	0.63/2.30*		472	40	—	16.0	HQD 355/4/2	1134	—	—	HRFD 355/4/2	0396		
Explosion proof Ex d II B, 1 ph., 230 Volt, 50 Hz, protection to IP 55, temp. class T1-T3																
1370	2940	180*	1.25*		757	40	—	18.0	HQW 355/4 Ex	0444	—	—	HRFW 355/4 Ex	0443		
Explosion proof Ex e II, 3 ph., 400 Volt, 50 Hz, protection to IP 55, temp. class T1-T3																
920	2010	250*	0.97*		470	40	—	25.0	HQD 355/6 Ex	1101	—	—	—	—		
1350	3060	120*	0.37*		470	40	—	18.0	HQD 355/4 Ex	1150	—	—	HRFD 355/4 Ex	0476		
2830	5910	1100*	2.60*		470	40	—	12.5	HQD 355/2 Ex	1261	—	—	HRFD 355/2 Ex	0136		

* Motor nominal values, Ex see info page 16.

¹⁾ Type HRFW: connect using wiring diagram no. SS-965.

²⁾ Incl. full motor protection.

³⁾ Incl. pole switch.

355/2

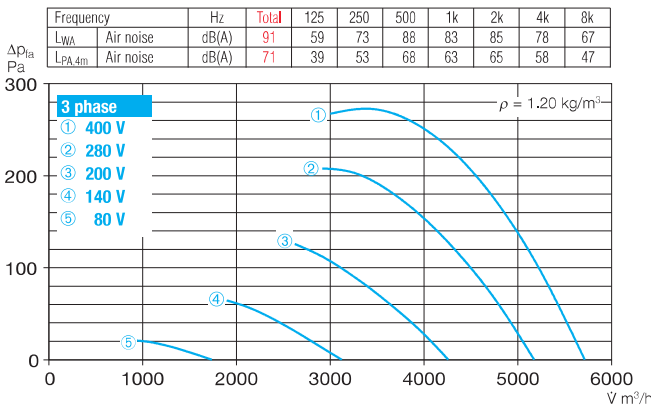

355/4

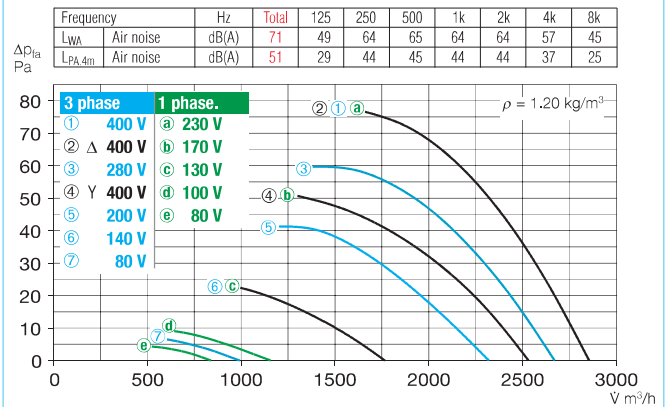

355/6

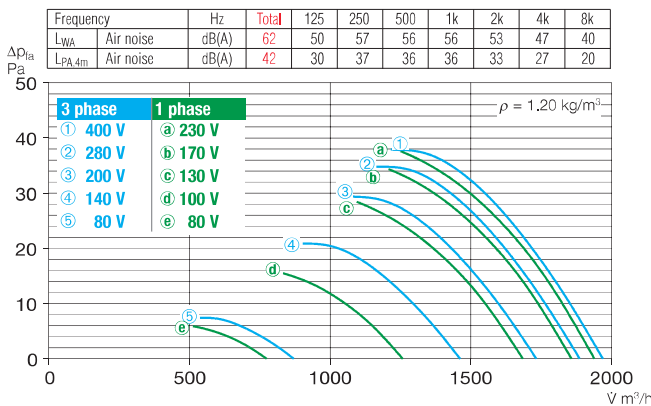

355/8

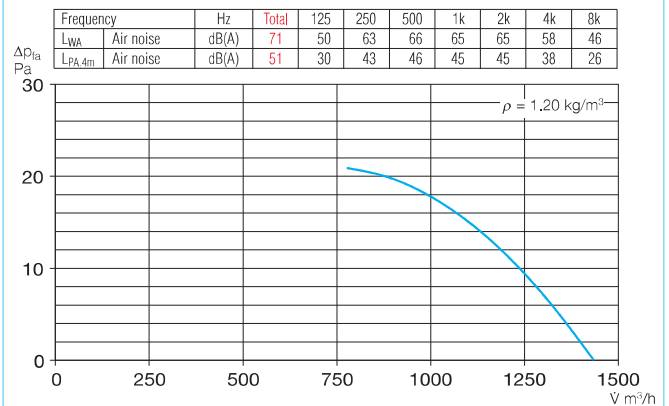

Accessories for HRF Description see page 230 on

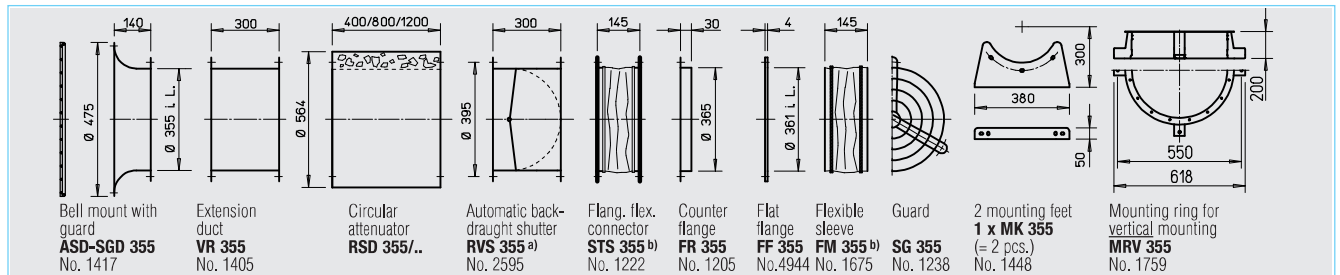

a) For motorised shutters see accessory page

b) Models for ex-proof fans see below

Frequency inverter with integrated Sine filter		Transformer controller 5-speed Pole switch		Electronic controller, stepless flush/surf.		Full motor protection for connection of integrated thermal contacts		Reversing switch	
Model	Ref. no.	Model	Ref. no.	Model	Ref. no.	Model	Ref. no.	Model	Ref. no.
—	—	MWS 1,5 ²⁾	1947	ESU 1/ESA 1	0236/0238	MW	1579	WS	1271
—	—	MWS 1,5 ²⁾	1947	ESU 1/ESA 1	0236/0238	MW	1579	WS	1271
FU-BS 2,5 ²⁾	5459	RDS 1 ²⁾	1314	—	—	MD	5849	WS	1271
FU-BS 2,5 ²⁾	5459	RDS 1 ²⁾	1314	—	—	MD	5849	WS	1271
FU-BS 2,5 ²⁾	5459	RDS 2 ²⁾	1315	ESD 5	0501	MD	5849	WS	1271
Speed switch		DS 2	1351	—	—	M 4 ³⁾ /MD	1571/5849	WS	1271
Pole switch		PDA 12 ⁴⁾	5081	—	—	M 3 ³⁾	1293	PWDA	1282
—	—	PDA 12 ⁴⁾	5081	—	—	MSA	1289	PWDA	1282
—	—	not permitted	not permitted	—	—	—	—	—	—
—	—	not permitted	not permitted	—	—	—	—	—	—
—	—	not permitted	not permitted	—	—	—	—	—	—
—	—	not permitted	not permitted	—	—	—	—	—	—

⁴⁾ See switch product page for flush mounted version.

Other accessories Page

b) Accessories for explosion proof fans	
Flanged flexible connector	Type STS 355 Ex Ref. no. 2504
Flexible sleeve	Type FM 355 Ex Ref. no. 1691
Extension tube for HS	
Type VH 355	Ref. no. 1345
Cylindrical duct, galvanised steel, length: 150 mm.	
Attenuators	421 on
Shutters and grilles	487 on
Speed controllers and switches	525 on

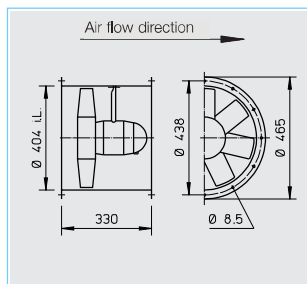
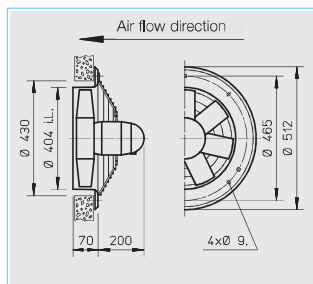
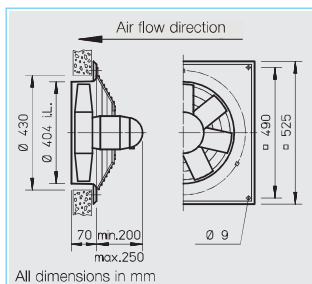

■ Specification for all models

□ Casing

Manufactured in galvanised sheet steel. Model HQ and HW have an additional two-layer finishing in papyrus white. Ex-models without paint.

□ Impeller

Highly efficient, profiled blade impeller, dynamically balanced and manufactured from impact resistant polymers. Suitable for -30 to +60 °C. Deviation for ex-models.

□ Motor

Totally enclosed motor with a die-cast aluminium casing, protected to IP 55. Ball bearing mounted. Maintenance-free and interference-free. Humidity protection of windings. For maximum air flow temp. see table below. Deviation for ex-models.

□ Motor protection

All models (explosion proof excluded) have thermal contacts as standard which must be connected to a motor protection unit (see below).

□ Electrical connection

Terminal box (IP 55) mounted on rear of motor as standard. Also on outside of piping for HRF. Deviation for ex-models.

□ Guard

Powder-coated steel wire for HQ and HW (HQ ex-models galvanised) according to DIN EN ISO 13857

□ Speed control

For all speed controllable models the current are identified with a value in the "speed controlled" column of the table below which must be used when selecting a controller. Possible allocations of frequency inverters are specified in the table below. The planned

use of a frequency inverter without Sine filter must be stated when ordering. This requires a change of fan design and potential additional costs. The air flow rates are shown in the performance curves.

□ Reversed operation

All models are reversible when wired to a reversing switch. For reverse air flow direction allow a loss in performance of approx. 1/3.

□ Installation

Installation in any position. Ensure that the motor drainage holes face downwards.

□ Dimensions

Pole-switch and explosion proof models may deviate from the information above.

□ Sound levels

See characteristic curve. The sound power and sound pressure are specified at 4 m distances under free field conditions, for average operating point suction/pressure side. See page 10 on for sound emission and acoustics. Deviation for ex-models.

Information	Page
Techn. description	140
Selection chart	141
Information for planning	10 on
Made to order designs	
Alternative voltages, protection classes, air flow direction, air flow temperature, acid protection and cast aluminium impellers are available on request.	
Note the technical information on page 15 on.	

R.P.M.	Air flow volume (FID)	Motor power	Current*		Wiring diagram	max. air flow temp. standard supply	speed controlled	Weight net	Model					
			standard-supply	max. controlled					HQ incl. guard	Ref. no.	HW incl. guard	Ref. no.	HRF	Ref. no.
min ⁻¹	∇ m ³ /h	W	A	A	No.	+°C	+°C	kg						
1 Phase motor, 230 Volt / 50 Hz, capacitor motor, protection to IP 55														
930	2570	77	0.52	0.54	475 ¹⁾	60	40	13.0	HQW 400/6	1110	—	—	HRFW 400/6 ¹⁾	0206
1350	4010	235	1.00	1.10	475 ¹⁾	60	40	14.0	HQW 400/4	1111	HWW 400/4	1008	HRFW 400/4 ¹⁾	0207
3 Phase motor, 400 Volt / 50 Hz, squirrel cage motor protection to IP 55														
950	2620	89	0.28	0.30	469	60	40	13.0	HQD 400/6	1123	—	—	—	—
1330	3960	200	0.40	0.40	469	60	40	14.0	HQD 400/4	1124	HWD 400/4	1025	HRFD 400/4	0229
Two-speed, 3 ph., 400 V, 50 Hz, Y/Δ switch, protection to IP 55														
1325/1085	3170/3920	135/205	0.25/0.45	0.45	520	60	40	20.0	HQD 400/4/4	1465	—	—	HRFD 400/4/4	1466
2890/2600	7890/8400	1300/2310*	3.00/5.60*	4.70	520	40	40	25.0	HQD 400/2/2	1475	—	—	HRFD 400/2/2	1474
2 speed motor, pole-switching, Dahlander windings, 400 Volt, 50 Hz, protection to IP 55														
690/1390	2010/4100	70/250	0.25/0.60	—	472	60	—	13.0	HQD 400/8/4	1137	—	—	HRFD 400/8/4	0399
1480/2940	4180/8540	300/2310*	1.00/5.20*	—	472	40	—	24.0	HQD 400/4/2	1139	—	—	HRFD 400/4/2	0401
Explosion proof Ex e II, 3 ph., 400 Volt, 50 Hz, protection to IP 55, temp. class T1-T3														
920	2870	250*	0.97*	—	470	40	—	13.0	HQD 400/6 Ex	1109	—	—	—	—
1370	4380	370*	1.08*	—	470	40	—	16.0	HQD 400/4 Ex	1153	—	—	HRFD 400/4 Ex	0479

* Motor nominal values, Ex see info page 16.

¹⁾ Type HRFW: connect using wiring diagram no. SS-965.

²⁾ Incl. full motor protection.

³⁾ Incl. pole switch.

400/2

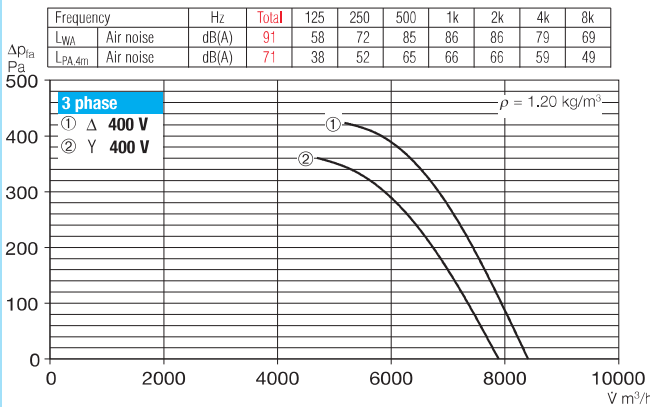

400/4

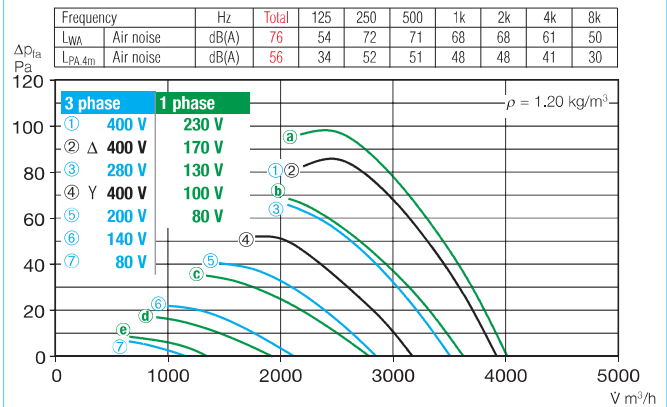

400/6

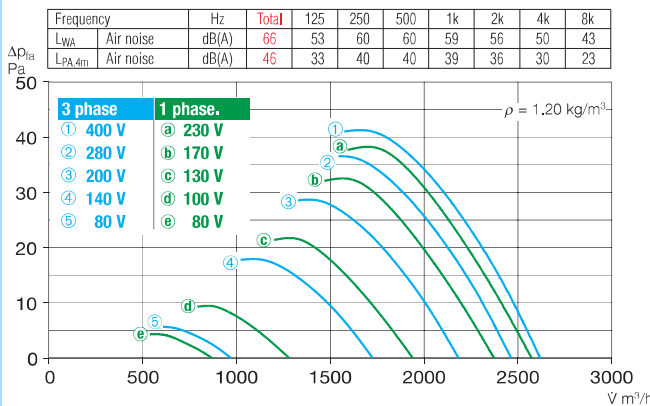

400/8

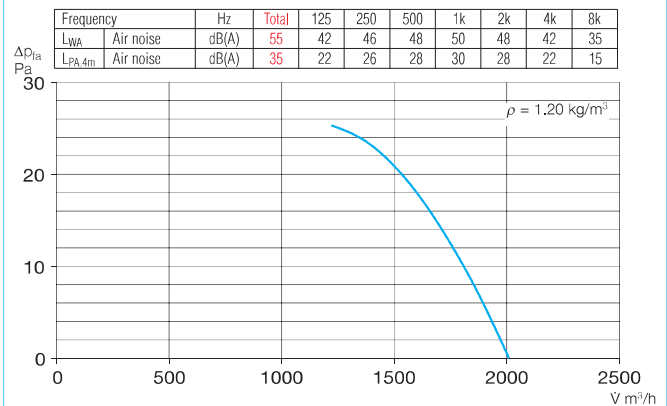

Accessories for HRF Description see page 230 on

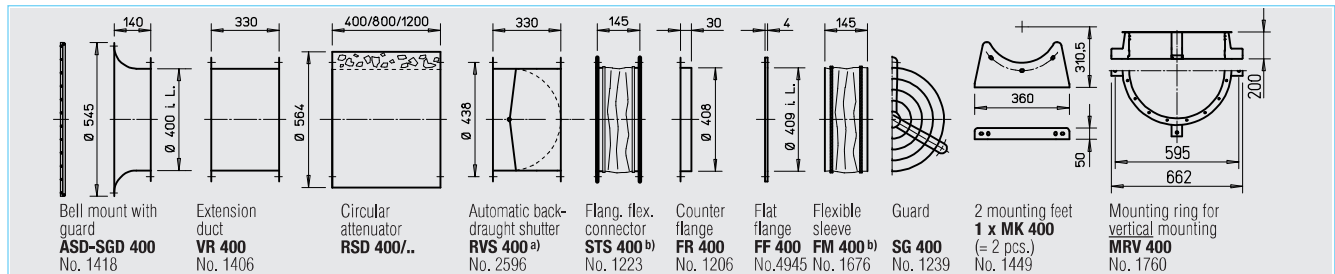

^{a)} For motorised shutters see accessory page

^{b)} Models for ex-proof fans see below

Frequency inverter with integrated Sine filter		Transformer controller 5-speed Pole switch		Electronic controller, stepless flush/surf.		Full motor protection for connection of integrated thermal contacts		Reversing switch	
Model	Ref. no.	Model	Ref. no.	Model	Ref. no.	Model	Ref. no.	Model	Ref. no.
—	—	MWS 1,5 ²⁾	1947	ESU 1/ESA 1	0236/0238	MW	1579	WS	1271
—	—	MWS 1,5 ²⁾	1947	ESU 3/ESA 3	0237/0239	MW	1579	WS	1271
FU-BS 2,5 ²⁾	5459	RDS 1 ²⁾	1314	—	—	MD	5849	WS	1271
FU-BS 2,5 ²⁾	5459	RDS 1 ²⁾	1314	—	—	MD	5849	WS	1271
Speed switch									
FU-BS 2,5 ²⁾	5459	RDS 1 ²⁾	1314	—	—	M 4 ⁴⁾ /MD	1571/5849	WS	1271
FU-BS 5 ²⁾	5460	DS 2	1351	ESD 5 ²⁾	0501	M 4 ⁴⁾ /MD	1571/5849	WS	1271
Pole switch									
—	—	PDA 12 ⁴⁾	5081	—	—	M 3 ³⁾	1293	PWDA	1282
—	—	PDA 12 ⁴⁾	5081	—	—	M 3 ³⁾	1293	PWDA	1282
—	—	not permitted	not permitted	—	—	—	—	—	—
—	—	not permitted	not permitted	—	—	—	—	—	—

⁴⁾ see switch product page for flush mounted version.

Other accessories	Page
^{b)} Accessories for explosion proof fans	
Flanged flexible connector Type STS 400 Ex	Ref. no. 2505
Flexible sleeve Type FM 400 Ex	Ref. no. 1692
Extension tube for HS Type VH 400	Ref. no. 1346
Cylindrical duct, galvanised steel, length: 150 mm.	
Attenuators	421 on
Shutters and grilles	487 on
Speed controllers and switches	525 on

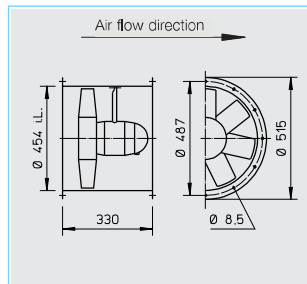
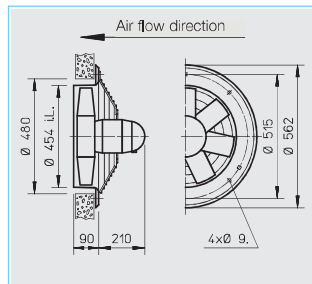
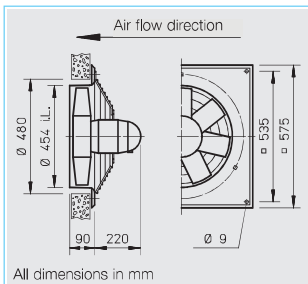

■ Specification for all models

□ Casing

Manufactured in galvanised sheet steel. Model HQ and HW have an additional two-layer finishing in papyrus white. Ex-models without paint.

□ Impeller

Highly efficient, profiled blade impeller, dynamically balanced and manufactured from impact resistant polymers. Suitable for -30 to +60 °C. Deviation for ex-models.

□ Motor

Totally enclosed motor with a die-cast aluminium casing, protected to IP 55. Ball bearing mounted. Maintenance-free and interference-free. Humidity protection of windings. For maximum air flow temp. see table below. Deviation for ex-models.

□ Motor protection

All models (explosion proof excluded) have thermal contacts as standard which must be connected to a motor protection unit (see below).

□ Electrical connection

Terminal box (IP 55) mounted on rear of motor as standard. Also on outside of piping for HRF. Deviation for ex-models.

□ Guard

Powder-coated steel wire for HQ and HW (HQ ex-models galvanised) according to DIN EN ISO 13857.

□ Speed control

For all speed controllable models the current are identified with a value in the "speed controlled" column of the table below which must be used when selecting a controller. Possible allocations of frequency inverters are specified in the table below. The planned use of a frequency inverter without Sine filter must be stated when ordering. This requires a change of fan design and potential additional costs. The air flow rates are shown in the performance curves.

□ Reversed operation

All models are reversible when wired to a reversing switch. For reverse air flow direction allow a loss in performance of approx. 1/3.

□ Installation

Installation in any position. Ensure that the motor drainage holes face downwards.

□ Dimensions

Pole-switch and explosion proof models may deviate from the information above.

□ Sound levels

See characteristic curve. The sound power and sound pressure are specified at 4 m distances under free field conditions, for average operating point suction/pressure side. See page 10 on for sound emission and acoustics. Deviation for ex-models.

R.P.M.	Air flow volume (FID)	Motor power	Current*		Wiring diagram	max. air flow temp.		Weight net	Model					
			standard-supply	max. controlled		standard supply	speed controlled		HQ incl. guard	Ref. no.	HW incl. guard	Ref. no.	HRF	Ref. no.
min ⁻¹	∇ m ³ /h	W	A	A	No.	+°C	+°C	kg						
1 Phase motor, 230 Volt / 50 Hz, capacitor motor, protection to IP 55														
915	3890	136	0.63	0.63	475 ¹⁾	60	40	19.0	HQW 450/6	0991	—	—	HRFW 450/6 ¹⁾	0208
1380	5770	405	1.76	2.02	475 ¹⁾	60	40	18.0	HQW 450/4	0992	HWW 450/4	1010	HRFW 450/4 ¹⁾	0209
3 Phase motor, 400 Volt / 50 Hz, squirrel cage motor protection to IP 55														
960	3920	137	0.38	0.42	469	60	40	18.0	HQD 450/6	0993	—	—	HRFD 450/6	0230
1390	5810	384	0.81	0.92	469	50	40	17.0	HQD 450/4	0994	HWD 450/4	1028	HRFD 450/4	0231
Two-speed, 3 ph., 400 V, 50 Hz, Y/Δ switch, protection to IP 55														
1130/1390	5090/5780	280/378	0.51/0.82	—	520	60	—	22.0	HQD 450/4/4	1467	—	—	HRFD 450/4/4	1468
2775/2200	10190/9335	1300/2310*	5.40/3.0*	5.10	520	40	40	32.0	—	—	—	—	HRFD 450/2/2	0484
2 speed motor, pole-switching, Dahlander windings, 400 Volt, 50 Hz, protection to IP 55														
480/970	1930/3950	62/163	0.22/0.47	—	472	60	—	18.0	HQD 450/12/6	0995	—	—	—	—
705/1410	2860/5810	91/404	0.36/0.92	—	472	50	—	20.0	HQD 450/8/4	0996	—	—	HRFD 450/8/4	0403
Explosion proof Ex e II, 3 ph., 400 Volt, 50 Hz, protection to IP 55, temp. class T1-T3														
920	4090	250*	0.97*	—	470	40	—	15.5	HQD 450/6 Ex	1473	—	—	—	—
1370	6240	370*	1.08*	—	470	40	—	15.5	HQD 450/4 Ex	1154	—	—	HRFD 450/4 Ex	0481

* Motor nominal values, Ex see info page 16.

¹⁾ Type HRFW: connect using wiring diagram no. SS-965.

²⁾ Incl. full motor protection.

³⁾ see switch product page for flush mounted version.

450/2

Frequency	Hz	Total	125	250	500	1k	2k	4k	8k	
LWA	Air noise	dB(A)	98	72	89	91	96	90	87	79
LPA,4m	Air noise	dB(A)	78	52	69	71	76	70	67	59

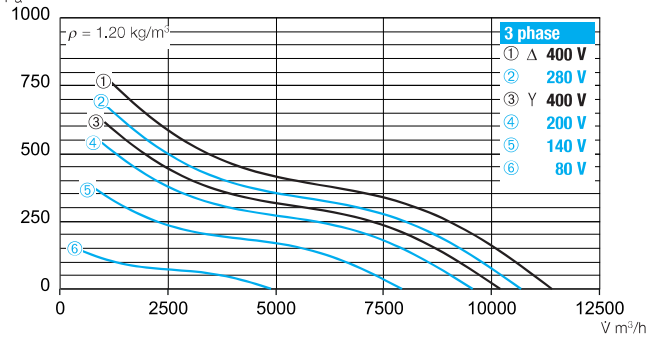

450/4

Frequency	Hz	Total	125	250	500	1k	2k	4k	8k	
LWA	Air noise	dB(A)	78	52	69	72	73	72	67	60
LPA,4m	Air noise	dB(A)	58	32	49	52	53	52	47	40

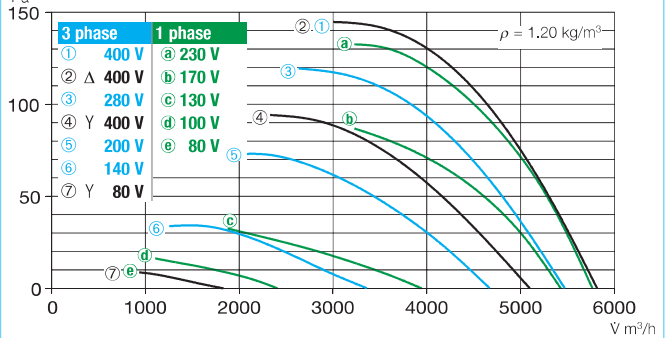

450/6

Frequency	Hz	Total	125	250	500	1k	2k	4k	8k	
LWA	Air noise	dB(A)	68	52	58	62	63	61	56	47
LPA,4m	Air noise	dB(A)	48	32	38	42	43	41	36	27

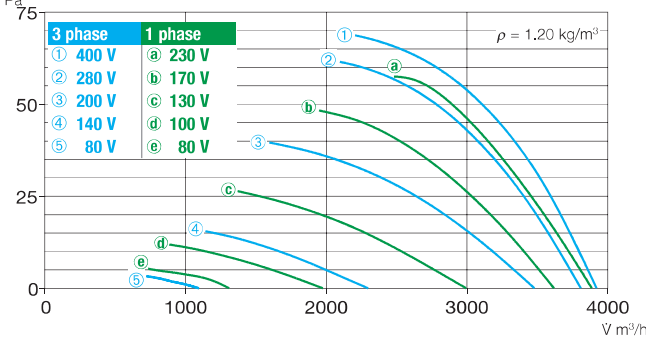

450/8

Frequency	Hz	Total	125	250	500	1k	2k	4k	8k	
LWA	Air noise	dB(A)	78	52	69	73	73	72	67	60
LPA,4m	Air noise	dB(A)	58	32	49	53	53	52	47	40

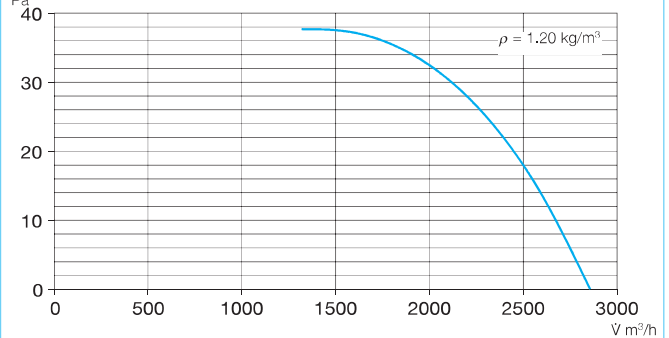

Accessories for HRF Description see page 230 on

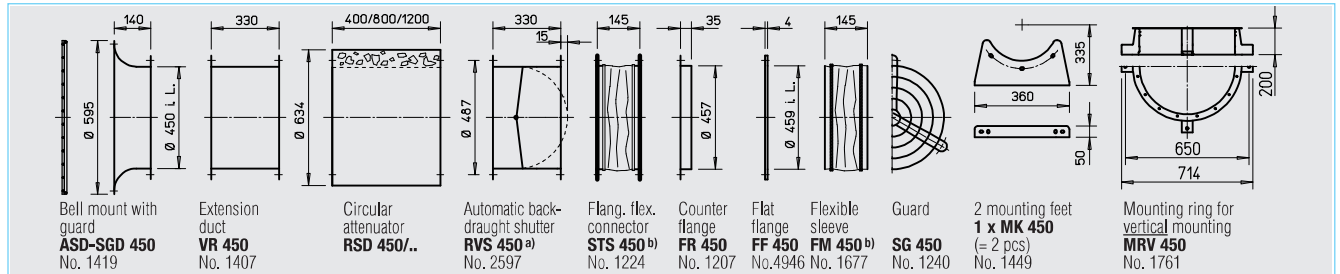

^{a)} For motorised shutters see accessory page

^{b)} Models for ex-proof fans see below

Frequency inverter with integrated Sine filter		Transformer controller 5-speed Pole switch		Electronic controller, stepless flush/surf.		Full motor protection for connection of integrated thermal contacts		Reversing switch	
Model	Ref. no.	Model	Ref. no.	Model	Ref. no.	Model	Ref. no.	Model	Ref. no.
—	—	MWS 1,5 ²⁾	1947	ESU 3/ESA 3	0237/0239	MW	1579	WS	1271
—	—	MWS 3 ²⁾	1948	ESU 3/ESA 3	0237/0239	MW	1579	WS	1271
FU-BS 2,5 ²⁾	5459	RDS 1 ²⁾	1314	—	—	MD	5849	WS	1271
FU-BS 2,5 ²⁾	5459	RDS 2 ²⁾	1315	ESD 5 ²⁾	0501	MD	5849	WS	1271
FU-BS 2,5 ²⁾	5459	DS 2 ⁵⁾	1351	—	—	M 4 ⁴⁾ /MD	1571/5849	WS	1271
FU-BS 8,0 ²⁾	5461	RDS 7 ²⁾	1578	ESD 11,5 ²⁾	0502	M 4 ⁴⁾ /MD	1571/5849	WS	1271
—	—	PDA 12 ³⁾	5081	—	—	M 3 ⁴⁾	1293	PWDA	1282
—	—	PDA 12 ³⁾	5081	—	—	M 3 ⁴⁾	1293	PWDA	1282
—	—	not permitted	not permitted	not permitted	not permitted	—	—	—	—
—	—	not permitted	not permitted	not permitted	not permitted	—	—	—	—

⁴⁾ Incl. pole switch.

⁵⁾ Speed switch.

Other accessories	Page
^{b)} Accessories for explosion proof fans	
Flanged flexible connector	
Type STS 450 Ex	Ref. no. 2506
Flexible sleeve	
Type FM 450 Ex	Ref. no. 1693
Attenuators	421 on
Shutters and grilles	487 on
Speed controllers and switches	525 on

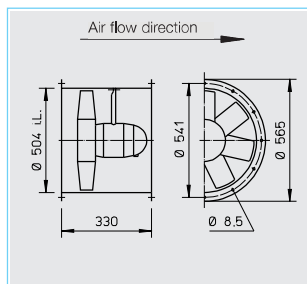
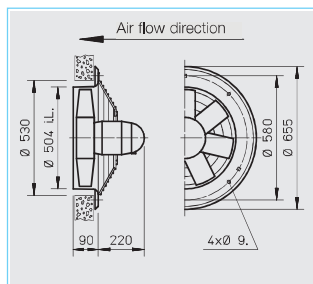
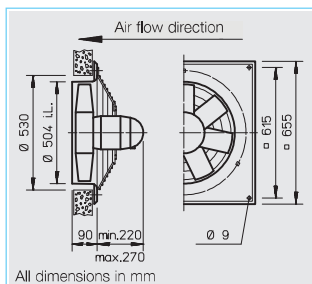

■ Specification for all models

□ Casing

Manufactured in galvanised sheet steel. Model HQ and HW have an additional two-layer finishing in papyrus white. Ex-models without paint.

□ Impeller

Highly efficient, profiled blade impeller, dynamically balanced and manufactured from impact resistant polymers. Suitable for -30 to +60 °C. Deviation for ex-models.

□ Motor

Totally enclosed motor with a die-cast aluminium casing, protected to IP 55. Ball bearing mounted. Maintenance-free and interference-free. Humidity protection of windings. For maximum air flow temp. see table below. Deviation for ex-models.

□ Motor protection

All models (explosion proof excluded) have thermal contacts as standard which must be connected to a motor protection unit (see below).

□ Electrical connection

Terminal box (IP 55) mounted on rear of motor as standard. Also on outside of piping for HRF. Deviation for ex-models.

□ Guard

Powder-coated steel wire for HQ and HW (HQ ex-models galvanised) according to DIN EN ISO 13857.

□ Speed control

For all speed controllable models the current are identified with a value in the "speed controlled" column of the table below which must be used when selecting a controller. Possible allocations of

frequency inverters are specified in the table below. The planned use of a frequency inverter without Sine filter must be stated when ordering. This requires a change of fan design and potential additional costs. The air flow rates are shown in the performance curves.

□ Reversed operation

All models are reversible when wired to a reversing switch. For reverse air flow direction allow a loss in performance of approx. 1/3.

□ Installation

Installation in any position. Ensure that the motor drainage holes face downwards.

□ Dimensions

Pole-switch and explosion proof models may deviate from the information above.

□ Sound levels

See characteristic curve. The sound power and sound pressure are specified at 4 m distances under free field conditions, for average operating point suction/pressure side. See page 10 on for sound emission and acoustics. Deviation for ex-models.

Information	Page
Techn. description	140
Selection chart	141
Information for planning	10 on
Made to order designs	
Alternative voltages, protection classes, air flow direction, air flow temperature, acid protection and cast aluminium impellers are available on request.	

R.P.M.	Air flow volume (FID)	Motor power	Current*		Wiring diagram	max. air flow temp.		Weight net	Model							
			standard-supply	max. controlled		standard supply	speed controlled		HQ incl. guard	Ref. no.	HW incl. guard	Ref. no.	HRF	Ref. no.		
min ⁻¹	∇ m ³ /h	W	A	A	No.	+°C	+°C	kg								
1 Phase motor, 230 Volt / 50 Hz, capacitor motor, protection to IP 55																
935	5500	233	1.05	1.25	475 ¹⁾	60	40	19.0	HQW 500/6	1112	—	—	HRFW 500/6 ¹⁾	0210		
1375	8320	1100*	5.90*	4.94	475 ¹⁾	40	40	25.0	HQW 500/4	1113	—	—	HRFW 500/4 ¹⁾	0211		
3 Phase motor, 400 Volt / 50 Hz, squirrel cage motor protection to IP 55																
920	5480	218	0.48	0.55	469	60	40	19.0	HQD 500/6	1126	—	—	HRFD 500/6	0232		
1345	8200	620	1.22	1.32	469	40	40	19.5	HQD 500/4	1127	HWD 500/4	1030	HRFD 500/4	0233		
Two-speed, 3 ph., 400 V, 50 Hz, Y/Δ switch, protection to IP 55																
615/920	4330/5450	133/214	0.29/0.46	—	520	60	—	18.0	HQD 500/6/6	1471	—	—	—	—		
1030/1350	6720/8150	416/617	0.76/1.19	—	520	60	—	24.0	HQD 500/4/4	1469	—	—	HRFD 500/4/4	1470		
2450/2830	13615/12050	1960/2470*	3.14/4.73*	—	520	40	—	30.0	—	—	—	—	HRFD 500/2/2	0485		
2 speed motor, pole-switching, Dahlander windings, 400 Volt, 50 Hz, protection to IP 55																
465/940	2680/5490	71/248	0.23/0.56	—	472	60	—	18.0	HQD 500/12/6	1140	—	—	—	—		
700/1385	3890/8280	137/688	0.52/1.48	—	472	40	—	22.0	HQD 500/8/4	1142	—	—	HRFD 500/8/4	0407		
Explosion proof Ex e II, 3 ph., 400 Volt, 50 Hz, protection to IP 55, temp. class T1-T3																
920	5610	250*	0.97*	—	470	40	—	18.0	HQD 500/6 Ex	1050	—	—	HRFD 500/6 Ex	0489		
1390	8560	750*	2.00*	—	470	40	—	18.0	HQD 500/4 Ex	1157	—	—	HRFD 500/4 Ex	0483		

* Motor nominal values, Ex see info page 16.

¹⁾ Type HRFW: connect using wiring diagram no. SS-965.

²⁾ Incl. full motor protection.

³⁾ Incl. pole switch.

500/2

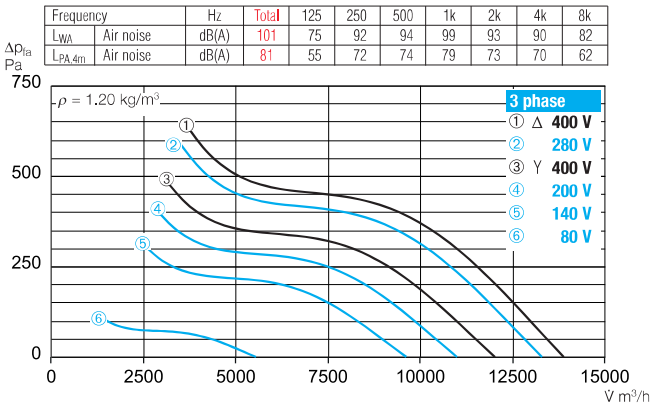

500/4

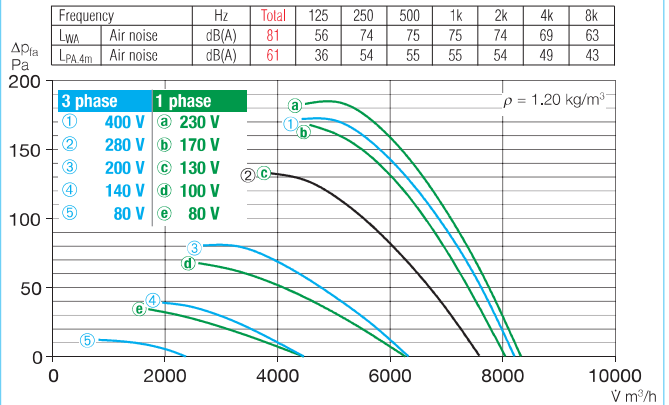

500/6

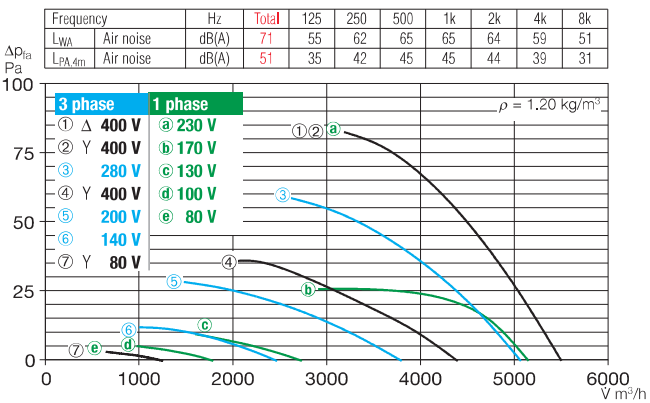

500/8

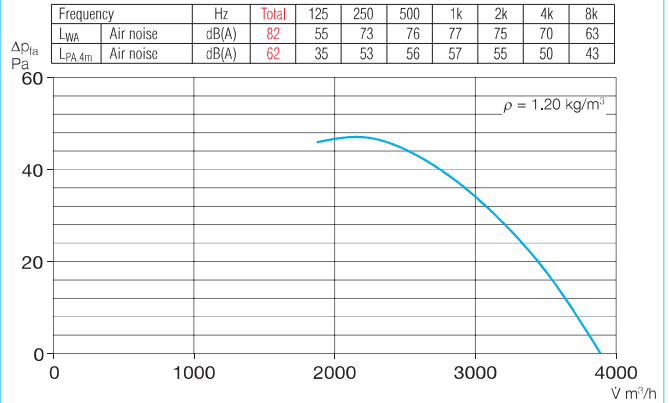

Accessories for HRF Description see page 230 on

Bell mount with guard ASD-SGD 500 No. 1420	Extension duct VR 500 No. 1408	Circular attenuator RSD 500/..	Automatic draught shutter RVS 500 a) No. 2598	Flang, flex. connector STS 500 b) No. 1225	Counter-flange FR 500 No. 1208	Flat flange FF 500 No. 4947	Flexible sleeve FM 500 b) No. 1678	Guard SG 500 No. 1241	2 mounting feet 1 x MK 500 (= 2 pcs) No. 1450	Mounting ring for vertical mounting MRV 500 No. 1740
---	---	--	--	---	---	--	---	------------------------------------	---	---

a) For motorised shutters see accessory page

b) Models for ex-proof fans see below

Frequency inverter with integrated Sine filter		Transformer controller 5-speed Pole switch		Electronic controller, stepless flush/surf.		Full motor protection for connection of integrated thermal contacts		Reversing switch	
Model	Ref. no.	Model	Ref. no.	Model	Ref. no.	Model	Ref. no.	Model	Ref. no.
—	—	MWS 1,5²⁾	1947	ESU 3/ESA 3	0237/0239	MW	1579	WS	1271
—	—	MWS 5²⁾	1949	ESU 5/ESA 5	1296/1299	MW	1579	WS	1271
FU-BS 2,5²⁾	5459	RDS 1²⁾	1314	ESD 5²⁾	0501	MD	5849	WS	1271
FU-BS 2,5²⁾	5459	RDS 2²⁾	1315	ESD 5²⁾	0501	MD	5849	WS	1271
Speed switch									
FU-BS 2,5²⁾	5459	DS 2⁵⁾	1351	—	—	M 4⁴⁾/MD	1571/5849	WS	1271
FU-BS 2,5²⁾	5459	DS 2⁵⁾	1351	ESD 5²⁾	0501	M 4⁴⁾/MD	1571/5849	WS	1271
FU-BS 5,0²⁾	5460	RDS 7²⁾	1578	ESD 11,5²⁾	0502	M 4⁴⁾/MD	1571/5849	WS	1271
Pole switch									
—	—	PDA 12⁴⁾	5081	—	—	M 3³⁾	1293	PWDA	1282
—	—	PDA 12⁴⁾	5081	—	—	M 3³⁾	1293	PWDA	1282
—	—	not permitted	not permitted	not permitted	not permitted	—	—	—	—
—	—	not permitted	not permitted	not permitted	not permitted	—	—	—	—

4) See switch product page for flush mounted version.

5) Speed switch.

Other accessories Page

b) Accessories for explosion proof fans	
Flanged flexible connector	Type STS 500 Ex Ref. no. 2507
Flexible sleeve	Type FM 500 Ex Ref. no. 1694
Extension tube for HS	
Type VH 500	Ref. no. 1348
Cylindrical duct, galvanised steel, length: 150 mm.	
Attenuators	421 on
Shutters and grilles	487 on
Speed controllers and switches	525 on

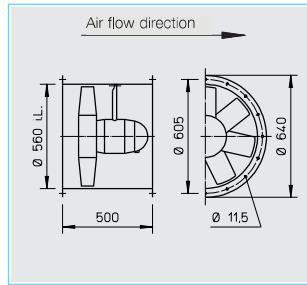
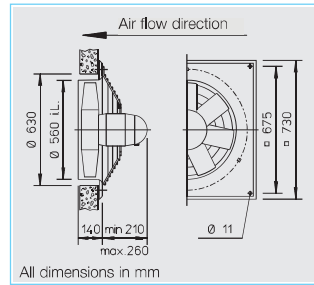

■ Specification for all models

□ Casing

Manufactured in galvanised sheet steel. Model HQ have an additional two-layer finishing in papyrus white. Ex-models without paint.

□ Impeller

Highly efficient, profiled blade impeller, dynamically balanced and manufactured from impact resistant polymers. Suitable for -30 to +60 °C. Deviation for ex-models.

□ Motor

Totally enclosed motor with a die-cast aluminium casing, protected to IP 55. Ball bearing mounted. Maintenance-free and interference-free. Humidity protection of windings. For maximum air flow temperature see table below. Deviation for ex-models.

□ Motor protection

All models (except explosion proof) have thermal contacts as standard which must be connected to a motor protection unit (see below) for effective motor protection.

□ Electrical connection

Terminal box (IP 55) mounted on rear of motor as standard. Also on outside of piping for HRF. Deviation for ex-models.

□ Guard

Powder-coated steel wire for HQ (Ex-models galvanised) according to DIN EN ISO 13857.

□ Speed control

For all speed controllable models the current are identified with a value in the "speed controlled" column of the table below which must be used when selecting a controller. Possible allocations of frequency inverters are specified in the table below. The planned use of a frequency inverter without Sine filter must be stated when ordering. This requires a change of fan design and potential additional costs. The air flow rates are shown in the performance curves.

□ Reversed operation

All models are reversible when wired to a reversing switch. For reverse air flow direction allow a loss in performance of approx. 1/3.

□ Installation

Installation in any position. Ensure that the motor drainage holes face downwards.

□ Dimensions

Pole-switch and explosion proof models may deviate from the information above.

□ Sound levels

See characteristic curve. The sound power and sound pressure are specified at 4 m distances under free field conditions, for average operating point suction/pressure side. See page 10 on for sound emission and acoustics. Deviation for ex-models.

R.P.M.	Air flow volume (FID)	Motor power (nominal)*	Current*		Wiring diagram	max. air flow temp. standard supply	speed controlled	Weight net	Model				Transformer controller for 5 speed pole switch		Electronic controller, stepless flush/surf.	
			standard-supply	max. controlled					HQ incl. guard	Ref. no.	HRF	Ref. no.	Model	Ref. no.	Model	Ref. no.
min ⁻¹	∇ m ³ /h	kW	A	A	No.	+°C	+°C	kg								
1 Phase motor, 230 Volt / 50 Hz, capacitor motor, protection to IP 55																
935	8130	0.27	1.40	2.00	475 ¹⁾	60	40	24.0	HQW 560/6	0385	HRFW 560/6 ¹⁾	0380	MWS 3 ²⁾	1948	ESU 3/ESA 3	0237/0239
1370	12180	0.89	4.15	5.00	965	60	40	31.0	HQW 560/4	5054	HRFW 560/4	5055	MWS 7,5 ²⁾	1950	ESU 5/ESA 5	1296/1299
3 Phase motor, 400 Volt / 50 Hz, squirrel cage motor protection to IP 55																
965	8180	0.28	0.79	1.00	469	60	40	26.0	HQD 560/6	0386	HRFD 560/6	0381	RDS 2 ²⁾	1315	ESD 5 ²⁾	0501
1365	12250	0.88	1.71	1.80	469	40	40	29.0	HQD 560/4	0387	HRFD 560/4	0382	RDS 2 ²⁾	1315	ESD 5 ²⁾	0501
2 speed motor, pole-switching, Dahlander windings, 400 Volt, 50 Hz, protection to IP 55																
470/955	4000/8130	0.089/0.298	0.55/0.74	—	472	60	—	24.0	HQD 560/12/6	0389	HRFD 560/12/6	0384	PDA 12 ³⁾	5081	—	—
720/1365	6400/12130	0.20/0.92	0.80/1.77	—	472	40	—	26.0	HQD 560/8/4	0388	HRFD 560/8/4	0383	PDA 12 ³⁾	5081	—	—
Explosion proof Ex e II, 3 ph., 400 Volt, 50 Hz, protection to IP 55, temp. class T1-T3																
920	8090	0.25*	0.97*	—	470	40	—	23.0	HQD 560/6 Ex	0378	HRFD 560/6 Ex	0376	not permitted	—	not permitted	—
1390	12890	0.75*	2.00*	—	470	40	—	24.0	HQD 560/4 Ex	0379	HRFD 560/4 Ex	0377	not permitted	—	not permitted	—

* Ex-models: for nominal value of motor see information on page 16 ¹⁾ Type HRFW: connect using wiring diagram no. SS-965 ²⁾ Incl. full motor protection ³⁾ see switch product page for flush mounted version

560/4

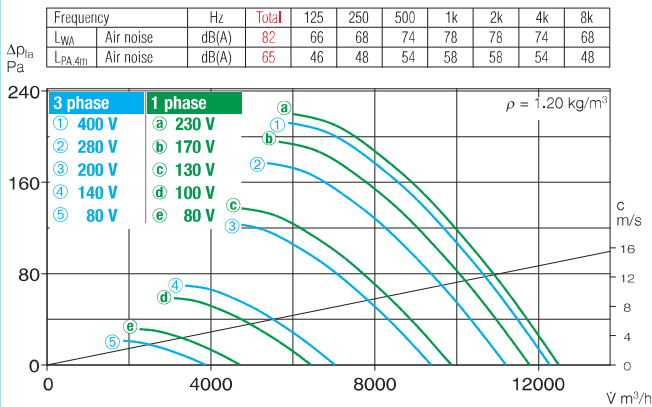

560/6

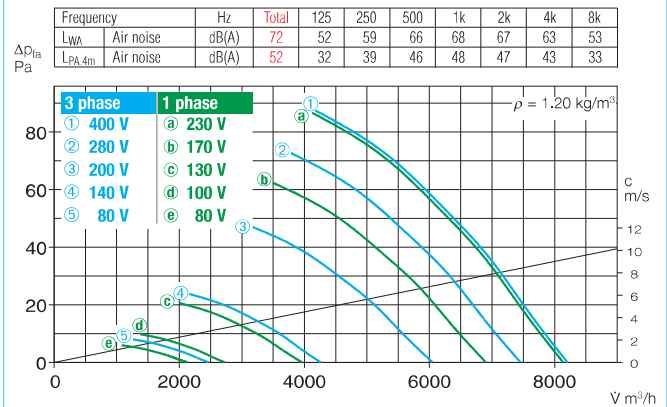

560/8

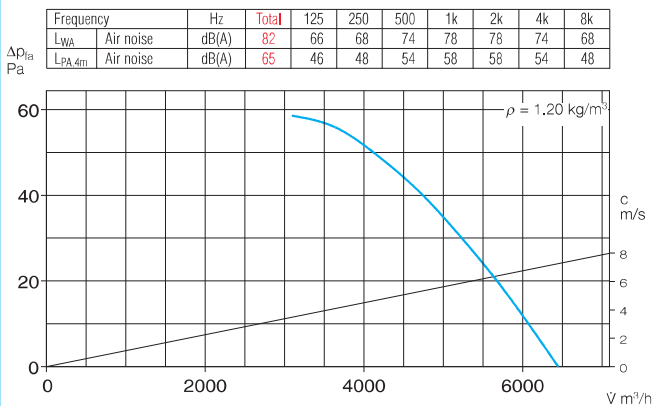

560/12

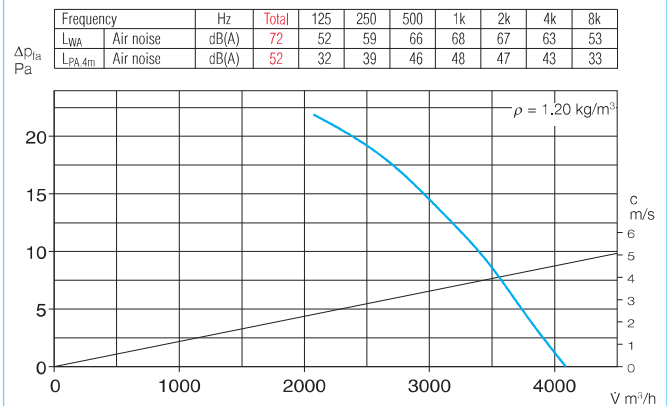

Accessories for HRF Description see page 230 on

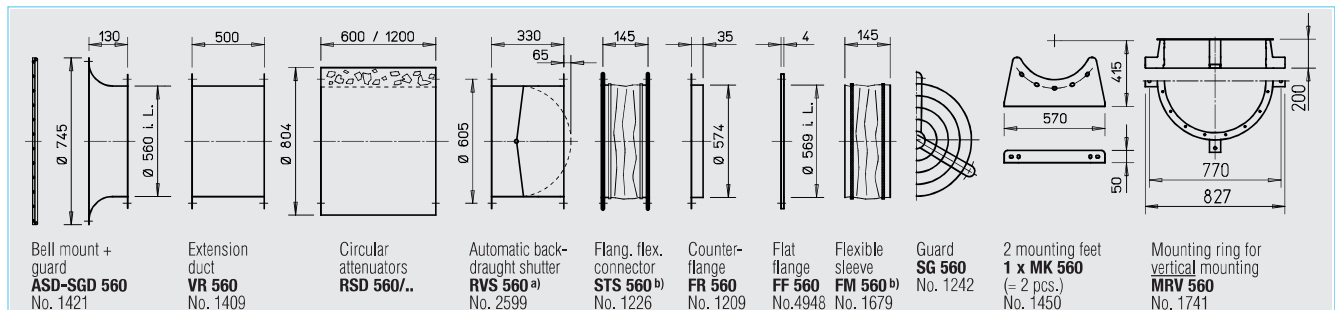

^{a)} For motorised shutters see accessory page

^{b)} Models for ex-proof fans see below

Electronic controller for stepless control		Full motor protection starter using the motor thermal contacts		Reversing switch	
Model	Ref. no.	Model	Ref. no.	Model	Ref. no.
—	—	MW	1579	WS	1271
—	—	MW	1579	WS	1271
FU-BS 2,5 ²⁾	5459	MD	5849	WS	1271
FU-BS 2,5 ²⁾	5459	MD	5849	WS	1271
—	—	M 3 ⁴⁾	1293	PWDA	1282
—	—	M 3 ⁴⁾	1293	PWDA	1282
—	—	—	—	—	—
—	—	—	—	—	—

⁴⁾ Incl. pole switch

Information	Page	Other accessories	Page
Techn. description	140	^{b)} Accessories for explosion proof fans	
Selection chart	141	Flanged flexible connector Type STS 560 Ex	Ref. no. 2508
Information for planning	10 on	Flexible sleeve Type FM 560 Ex	Ref. no. 1695
Made to order designs		Attenuators	434 on
Alternative voltages, protection classes, air flow direction, air flow temperature, acid protection and cast aluminium impellers are available on request.		Shutter and grilles	487 on
Note the technical information on page 15 on.		Speed controllers and switches	525 on

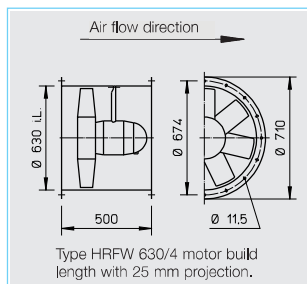
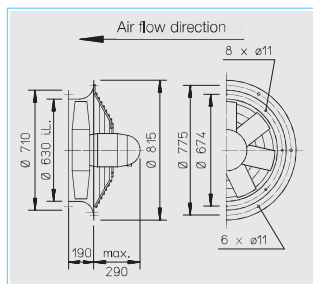
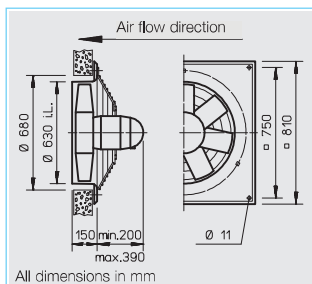
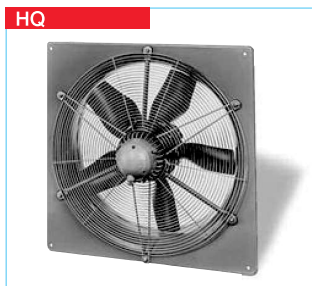

■ Specification for all models

□ Casing

Manufactured in galvanised sheet steel.

□ Impeller

Highly efficient, profiled blade impeller, dynamically balanced and manufactured from impact resistant polymers. Suitable for -30 to +60 °C. Deviation for ex-models.

□ Motor

Totally enclosed motor with a die-cast aluminium casing, protected to IP 55. Ball bearing mounted. Maintenance-free and interference-free. Humidity protection of windings. For maximum air flow temperature see table below. Deviation for ex-models.

□ Motor protection

All models (except/8/4 and explosion proof) have thermal contacts as standard which must be connected to a motor protection unit (see below) for effective motor protection. Motors without thermal contacts must be protected by a conventional circuit breaker.

□ Electrical connection

Terminal box (IP 55) mounted on motor as standard. Also on outside of piping for HRF. Deviation for ex-models.

□ Guard

Powder-coated steel wire for HQ and HW (HQ.. Ex galvanised) according to DIN EN ISO 13857.

□ Speed control

For all speed controllable models the current are identified with a value in the "speed controlled" column of the table below which must be used when selecting a controller. Possible allocations of frequency inverters are specified in the table below. The planned use of a frequency inverter without Sine filter must be stated when ordering. This requires a change of fan design and potential additional costs. The air flow rates are shown in the performance curves.

□ Reversed operation

All models are reversible when wired to a reversing switch. For reverse air flow directional low a loss in performance of approx. 1/3.

□ Installation

Installation in any position. Ensure that the motor drainage holes face downwards.

□ Dimensions

Pole-switch and explosion proof models may deviate from the information above.

□ Sound levels

See characteristic curve. The sound power and sound pressure are specified at 4 m distances under free field conditions, for average operating point suction/pressure side. See page 10 on for sound emission and acoustics. Deviation for ex-models.

R.P.M.	Air flow volume (FID)	Motor power (nominal)*	Current*		Wiring diagram	max. air flow temp.		Weight net	Model						Transformer controller for 5 speed pole switch	
			standard-supply	max. controlled		standard supply	speed controlled		HQ incl. guard	Ref. no.	HW incl. guard	Ref. no.	HRF	Ref. no.	Model	Ref. no.
min ⁻¹	∇ m ³ /h	kW	A	A	No.	+°C	+°C	kg								
1 Phase motor, 230 Volt / 50 Hz, capacitor motor, protection to IP 55																
950	10530	0.44	2.16	3.20	475	60	40	28.0	HQW 630/6	5037	—	—	—	—	MWS 3 ¹⁾	1948
1325	16210	1.50*	8.40*	7.00	964	40	—	40.0	HQW 630/4	5056	—	—	HRFW 630/4	5057	MWS 7,5 ¹⁾	1950
3 Phase motor, 400 Volt / 50 Hz, squirrel cage motor protection to IP 55																
710	7810	0.20	0.66	0.70	469	40	40	27.0	HQD 630/8	5029	—	—	—	—	RDS 2 ¹⁾	1315
960	10560	0.44	1.22	—	469	60	40	30.5	HQD 630/6	5027	HWD 630/6	1032	HRFD 630/6	0244	RDS 2 ¹⁾	1315
Two-speed, 3 ph., 400 V, 50 Hz, Y/Δ switch, protection to IP 55																
1170/1390	14310/17000	0.90/1.57	2.3/3.8	—	520	40	—	37.5	HQD 630/4/4	5030	HWD 630/4/4	1033	HRFD 630/4/4	0245	RDS 4 ¹⁾	1316
2 speed motor, pole-switching, Dahlander windings, 400 Volt, 50 Hz, protection to IP 55																
440/935	5290/10470	0.14/0.43	0.60/1.13	—	472	60	—	41.0	HQD 630/12/6	5031	—	—	HRFD 630/12/6	0410	PDA 12 ²⁾	5081
690/1400	7990/15990	0.37/1.50*	1.33/3.70*	—	471	40	—	40.5	HQD 630/8/4	5032	—	—	HRFD 630/8/4	0411	PDA 12 ²⁾	5081
Explosion proof Ex e II, 3 ph., 400 Volt, 50 Hz, protection to IP 55, temp. class T1-T3																
910	10480	0.55*	1.75*	—	470	40	—	30.0	HQD 630/6 Ex	5035	—	—	HRFD 630/6 Ex	0494	not permitted	
1410	17730	1.35*	3.10*	—	470	40	—	35.0	HQD 630/4 Ex	5036	—	—	HRFD 630/4 Ex	0495	not permitted	

* Ex-models: for nominal value of motor see information on page 16

¹⁾ Incl. full motor protection

²⁾ see switch product page for flush mounted version

630/4

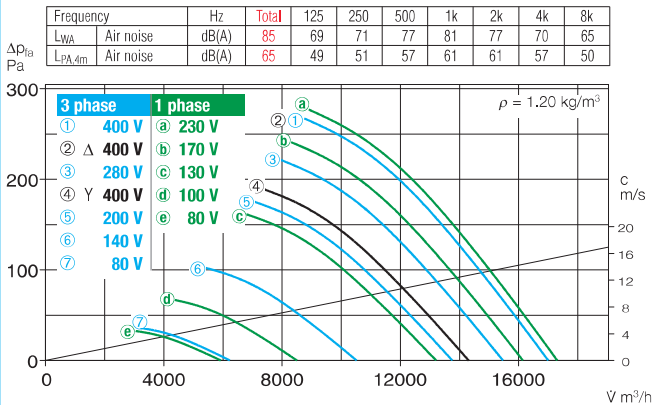

630/6

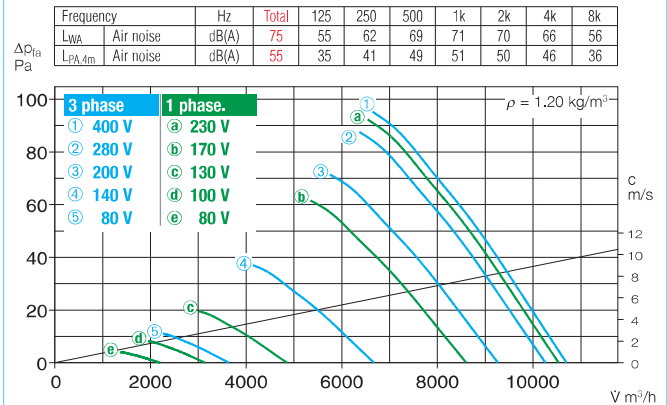

630/8

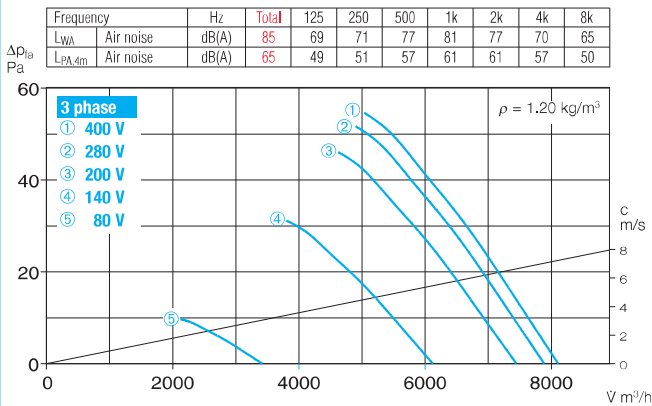

630/12

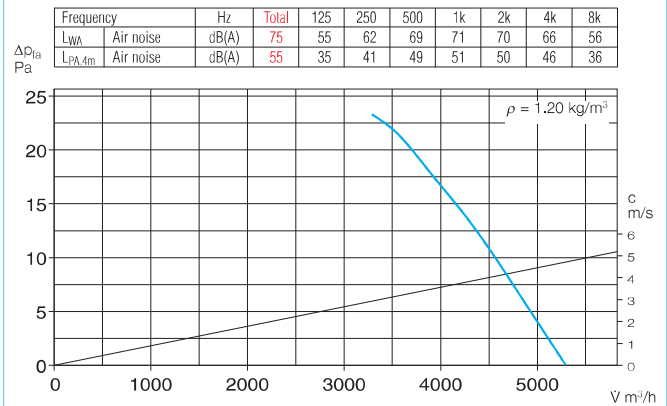

Accessories for HRF Description see page 230 on

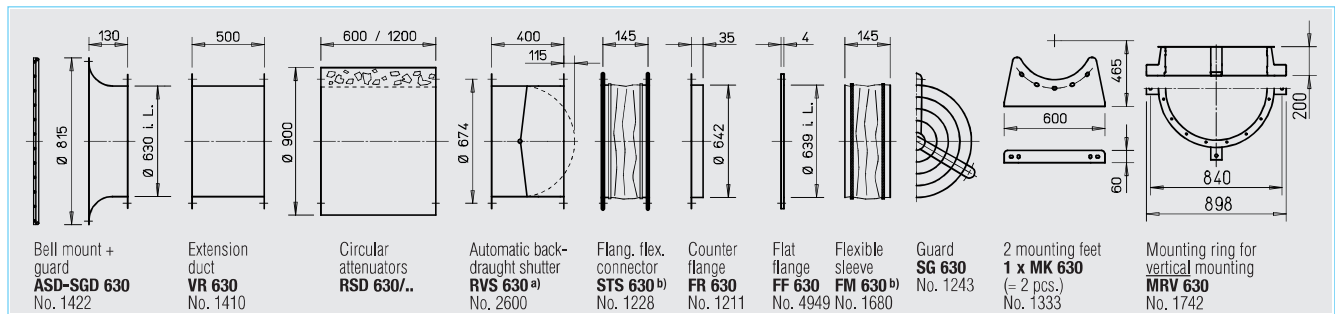

^{a)} For motorised shutters see accessory page

^{b)} Models for ex-proof fans see below

Frequency inverter with integrated Sine filter	Electronic controller, stepless flush/surf.	Full motor protection for connection of integrated thermal contacts	Reversing switch				
Model	Ref. no.	Model	Ref. no.	Model	Ref. no.	Model	Ref. no.
—	—	ESU 5/ESA 5	1296/1299	MW	1579	WS	1271
—	—	—	—	MW	1579	WS	1271
FU-BS 2,5¹⁾	5459	ESD 5¹⁾	0501	MD	5849	WS	1271
FU-BS 2,5¹⁾	5459	ESD 5¹⁾	0501	MD	5849	WS	1271
FU-BS 5,0¹⁾	5460	ESD 5¹⁾	0501	M 4³⁾	1571	WS	1271
—	—	—	—	M 3³⁾	1293	PWDA	1282
—	—	—	—	M 3³⁾	1293	PWDA	1282
—	—	not permitted	—	—	—	—	—
—	—	not permitted	—	—	—	—	—

³⁾ Incl. pole switch

Information	Page	Other accessories	Page
Techn. description	140	^{b)} Accessories for explosion proof fans	
Selection chart	141	Flanged flexible connector	
Information for planning	10 on	Type STS 630 Ex	Ref. no. 2509
Made to order designs		Flexible sleeve	
Alternative voltages, protection classes, air flow direction, air flow temperature, acid protection and cast aluminium impellers are available on request.		Type FM 630 Ex	Ref. no. 1696
Note the technical information on page 15 on.		Attenuators	434 on
		Shutter and grilles	487 on
		Speed controllers and switches	525 on

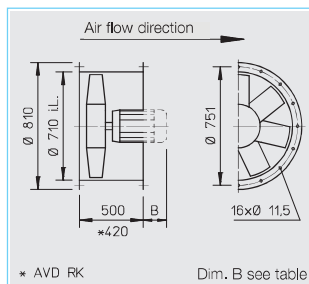
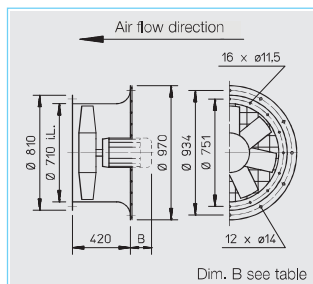
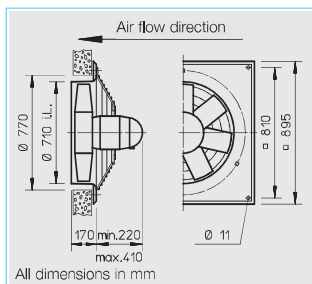
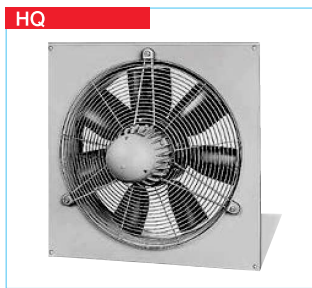

■ Specification for all models

□ Casing

With motor support manufactured from galvanised sheet steel.

□ Impeller

Highly efficient, profiled blade impeller, dynamically balanced and manufactured from impact resistant polymers. Suitable for -30 to +60 °C. Deviation for ex-models.

□ Pitch angle

The impeller blades are adjustable for the optimal coverage of the operating point (except HQW 710/6 and explosion proof). The pitch angle is set at the factory (according to the

order) and fixed. The motor allocation takes place using the maximum power pursuant to the information in the table below. The specified pitch angle shown for each motor must not be exceeded.

□ Motor

Totally enclosed motor protected to IP 55. Maintenance-free and interference-free. Humidity protection of tropicalized windings. Deviation for ex-models.

□ Motor protection

All models (except pole switching and explosion proof) have thermal contacts or PTC thermistors and according to footnotes in the table to protect

through the following full motor protection units:

- ¹⁾MW/MD, Ref. no. 1579/5849
 - ²⁾MSA, Ref. no. 1289 (for PTC thermistor temp. sens)
 - ³⁾M4, Ref. no. 1571
- All other models have to be protected by a conventional circuit breaker on site.

□ Guard

Hot-dipped or powder-coated as standard for HQ and AVD DK according to DIN EN ISO 13857.

□ Electrical connection

Terminal box protected to IP 54 mounted on motor. Outside of piping for HRF. Deviation for ex-models.

□ Speed control

Partial through voltage reduction, see the "transformer controller" column. Regulated performance curve upon request. Possible allocations of frequency inverters for all types (except pole-switch and ex-proof). The planned use of a frequency inverter without Sine filter must be stated when ordering. This requires a change of fan design and potential additional costs.

□ Reversed operation

All models are reversible when wired to a reversing switch. For reverse air flow direction allow a loss in performance of approx. 1/3.

□ Installation

Installation in any position. Ensure that the motor drainage holes face downwards.

□ Dimensions

Pole-switch and explosion proof models may deviate from the adjacent information. Motor build lengths vary. Note dimension B projection.

□ Sound levels

The sound power levels are specified through the frequency and as sum levels above the characteristic curves. Deviation for ex-models.

R.P.M.	Air flow volume (FID)	Motor power (nominal)*	Voltage	Power con. nom. volt./ (control)*	max. pitch angle	Wiring diagram	max. air flow temp.	Weight net ¹⁾	Model				Dim. B motor projection	Transformer controller for 5 speed pole switch		
									HQ incl. guard	Ref. no.	AVD DK incl. guard	Ref. no.		HRFD, AVD RK	Ref. no.	mm
min ⁻¹	∇ m ³ /h	kW	V	A	°	No.	+°C	kg								
1 Phase motor, 230 Volt / 50 Hz, capacitor motor, protection to IP 55																
910	14200	0.60	230	2.6	25	965	40	40.0	HQW 710/6 ¹⁾	5047	—	—	—	—	MWS 5 ⁴⁾	1949
3 Phase motor, 400 Volt / 50 Hz, squirrel cage motor protection to IP 55																
690	13330	0.29	400	0.9	20	469	40	57.0	HQD 710/8 ¹⁾	5599	AVD DK 710/8 ¹⁾	5251	HRFD 710/8 ¹⁾	6930	95	RDS 2 ⁴⁾ 1315
940	15560/19170	1.1*	230/400	5.1*	35	499	40	60.0	HQD 710/6 ¹⁾	5603	AVD DK 710/6 ¹⁾	5255	HRFD 710/6 ¹⁾	6934	135	RDS 7 ⁴⁾ 1578
1445	26420	3.00*	400/690	6.2*	30	776	40	88.0	HQD 710/4 ²⁾	5606	AVD DK 710/4 ²⁾	5258	HRFD 710/4 ²⁾	6937	180	—
Two-speed, 3 ph., 400 V, 50 Hz, protection to IP 55																
730/890	13550/16090	0.4/0.75*	400/400	1.1/2.3*	25	520	40	55.0	HQD 710/6/6 ³⁾	5602	AVD DK 710/6/6 ³⁾	5254	HRFD 710/6/6 ³⁾	6933	95	RDS 4 ⁴⁾ 1316
1120/1360	16140/19670	0.95/1.55*	400/400	2.4/4.2*	20	520	40	60.0	HQD 710/4/4 ³⁾	5604	AVD DK 710/4/4 ³⁾	5256	HRFD 710/4/4 ³⁾	6935	135	RDS 7 ⁴⁾ 1578
1030/1340	19370/23280	1.5/2.2*	400/400	3.0/5.2*	26	520	40	75.0	HQD 710/4/4 ³⁾	5605	AVD DK 710/4/4 ³⁾	5257	HRFD 710/4/4 ³⁾	6936	180	RDS 7 ⁴⁾ 1578
2 speed motor, pole-switching, Dahlander windings, 400 Volt, 50 Hz, protection to IP 54																
685/1430	10810/22090	0.5/2.0*	400/400	2.0/4.7	23	471	40	82.0	HQD 710/8/4/..	5611	AVD DK 710/8/4/..	5263	HRFD 710/8/4/..	6942	180	PDA 12 ⁵⁾ 5081
720/1440	14155/29020	0.9/3.6*	400/400	2.9/8.3	30	471	40	108.0	HQD 710/8/4/..	5612	AVD DK 710/8/4/..	5264	AVD RK 710/8/4/..	6943	210	PDA 12 ⁵⁾ 5081
Explosion proof Ex e II, 3 ph., 400 Volt, 50 Hz, protection to IP 55, temp. class T1-T3																
700	10450	0.55*	400	2.2*	35	470	40	68.0	HQD 710/8 Ex	5618	AVD DK 710/8 Ex	5270	HRFD 710/8 Ex	6948	125	not permitted
930	13480	0.55*	400	1.8*	25	470	40	67.0	HQD 710/6 Ex	5620	AVD DK 710/6 Ex	5272	HRFD 710/6 Ex	6949	95	not permitted
930	16770	0.95*	400	2.7*	35	470	40	77.0	HQD 710/6 Ex	5621	AVD DK 710/6 Ex	5273	HRFD 710/6 Ex	6950	135	not permitted
1420	20540	2.00*	400	4.7*	25	470	40	82.0	HQD 710/4 Ex	5623	AVD DK 710/4 Ex	5275	AVD RK 710/4 Ex	6951	180	not permitted
1420	26160	3.60*	400/690	8.1*	35	498	40	102.0	HQD 710/4 Ex	5624	AVD DK 710/4 Ex	5276	AVD RK 710/4 Ex	6952	200	not permitted

¹⁾ Nominal motor amounts, Ex see info p. 16.

²⁾ to ³⁾ full motor protection unit, see "Motor protection" desc.

⁴⁾ ** Weights apply for type ..DK and ..RK, HRF and HQ less approx. 15 kg.

⁵⁾ ⁴⁾ Incl. full motor protection.

710/4 R.P.M. = 1450

Frequency	Hz	Total	125	250	500	1k	2k	4k	8k
LWA 15°		dB(A) 87	71	72	79	82	83	79	72
LWA 25°		dB(A) 89	73	74	81	84	85	81	74
LWA 35°		dB(A) 91	75	76	83	86	87	83	76

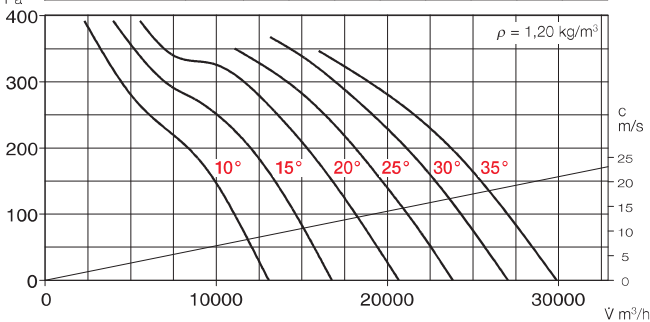
710/6 Three-phase R.P.M. = 950

Frequency	Hz	Total	125	250	500	1k	2k	4k	8k
LWA 15°		dB(A) 79	63	65	71	74	74	71	63
LWA 25°		dB(A) 81	65	67	73	76	76	73	65
LWA 35°		dB(A) 83	67	69	75	78	78	75	67

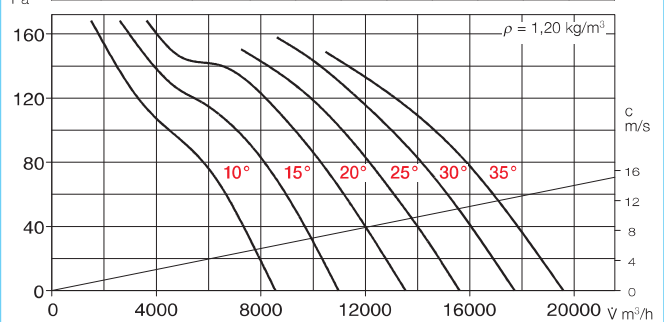
710/6 Single phase

Frequency	Hz	Total	125	250	500	1k	2k	4k	8k
LWA 15°		dB(A) 79	63	65	71	74	74	71	63
LWA 25°		dB(A) 81	65	67	73	76	76	73	65
LWA 35°		dB(A) 83	67	69	75	78	78	75	67

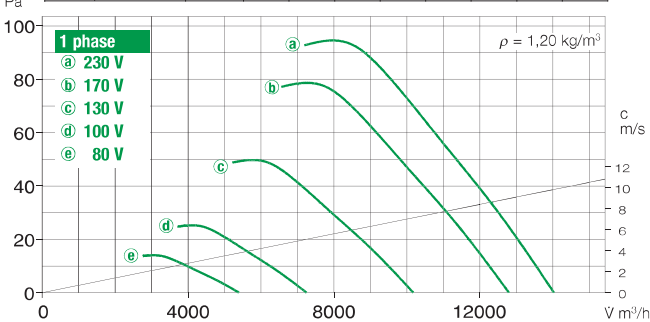

710/8 R.P.M. = 700

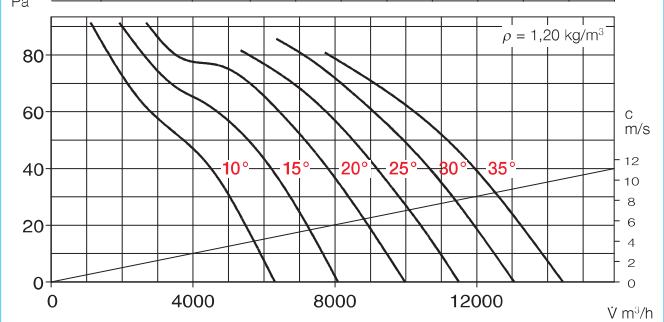
Frequency	Hz	Total	125	250	500	1k	2k	4k	8k
LWA 15°		dB(A) 72	53	58	65	68	67	63	54
LWA 25°		dB(A) 74	55	60	67	70	69	65	56
LWA 35°		dB(A) 76	57	62	69	72	71	67	58

Accessories for HRF / AVD RK Description see page 230 on

Electronic controller, stepless Frequency inverter with Sine filter		Vibration dampers nominal size	
Model	Ref. no.	SDD / SDZ Model	Ref. no.
—	—	..1/..1	1452/1454
ESD 5 ⁴⁾	0501	..1/..1	1452/1454
ESD 11,5 ⁴⁾	0502	..1/..1	1452/1454
FU-BS 8,0 ⁴⁾	5461	..2/..2	1453/1455
ESD 5 ⁴⁾	0501	..1/..1	1452/1454
ESD 5 ⁴⁾	0501	..1/..1	1452/1454
ESD 11,5 ⁴⁾	0502	..1/..2	1452/1455
—	—	..2/..2	1453/1455
—	—	..2/..2	1453/1455
not permitted	—	..1/..2	1452/1454
not permitted	—	..1/..2	1452/1454
not permitted	—	..1/..2	1452/1454
not permitted	—	..2/..2	1453/1455
not permitted	—	..2/..2	1453/1455

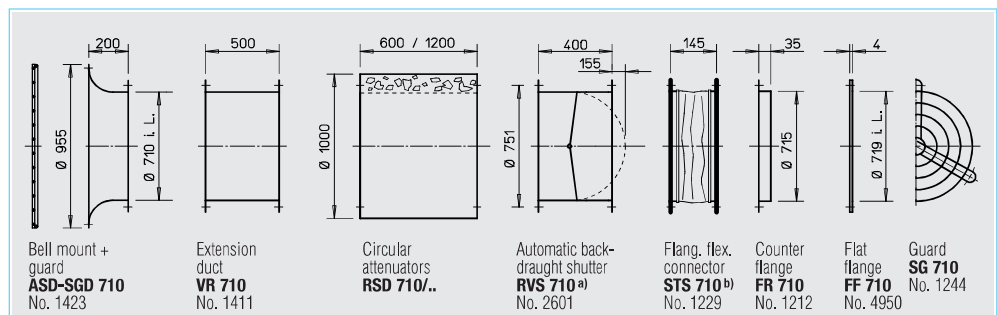
4) see switch product page for flush mounted version.



a) For motorised shutters see accessory page

b) Models for ex-proof fans see below

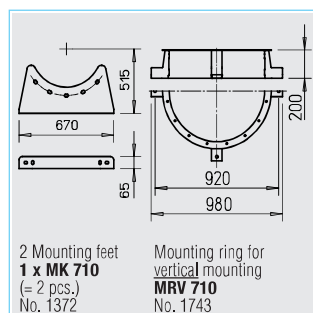

Information	Page	Other accessories	Page
Techn. description	140	b) Accessories for explosion proof fans	
Selection chart	141		
Information for planning	10 on		
Made to order designs		Flanged flexible connector	
Alternative voltages, protection classes, air flow direction, air flow temperature, acid protection and cast aluminium impellers are available on request.		Type STS 710 Ex Ref. no. 2510	
		Attenuators	434 on
		Shutter and grilles	487 on
		Speed controllers and switches	525 on