



JETLINE

5145895700 - JETLINE-125 (220/240V50/60HZ) N8 - IN LINE DUCT FANS



In-line fan for circular duct with low profile compact casing manufactured from galvanised sheet steel and rubber gasket on the flanges. High performance impeller, guide vane and outlet diffuser manufactured from injection-moulded plastic, to increase performances and lower the sound level. IP55 terminal box fixed on the casing.

Mounting bracket supplied with the fan, enabling to mount the fan in two different positions and any shaft orientation

Motor

Single-phase external rotor motor assembled with antivibration mount to reduce vibration and noise level, 220-240V50/60Hz, IP44, class F, with thermal protection and speed regulable by tension.

Working temperature -20/60°C

Model JETLINE-125 (220/240V50/60HZ) N8.

Theoretical Working Point

Airflow	-
Static Pressure	0,000 Pa
Temperature	20 °C
Altitude	0 m
Density	1,2 kg/m ³
Frequency	50 Hz

Construction

Discharge diameter	125 mm
Fan size	125

Motor Characteristics

Number of poles	2
Voltage	1-230V-50Hz
Maximum absorbed current	0,2 A
IP Rating	IP44
Motor insulation class	F

Drawing

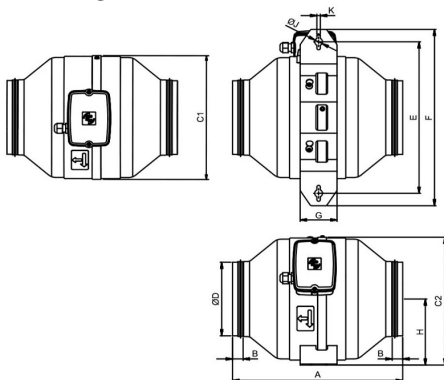

A	B	C1	C2	øD	E	F	G	H
279	15	206	214	120	265	315	70	111

øJ	K
15	6.5

Performance Chart

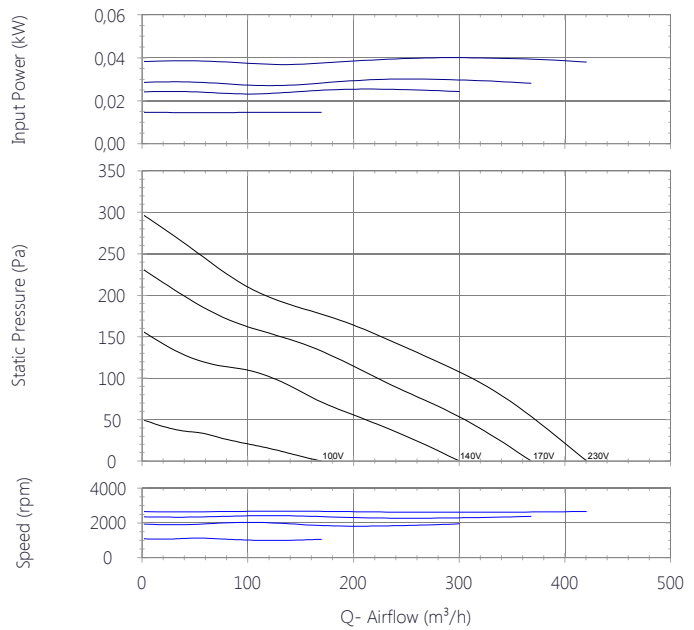

Sound Performance

	63	125	250	500	1k	2k	4k	8k	Overall
Inlet (LwA)	41	38	52	63	55	56	52	43	65
Inlet LpA @ 1m	30	27	41	52	44	45	41	32	54
Outlet (LwA)	29	45	52	61	56	56	54	41	64
Outlet LpA @ 1m	18	34	41	50	45	45	43	30	53
Breakout (LwA)	31	25	27	37	34	35	33	25	42
Breakout LpA @ 1m	20	14	16	26	23	24	22	14	31





Performance Chart

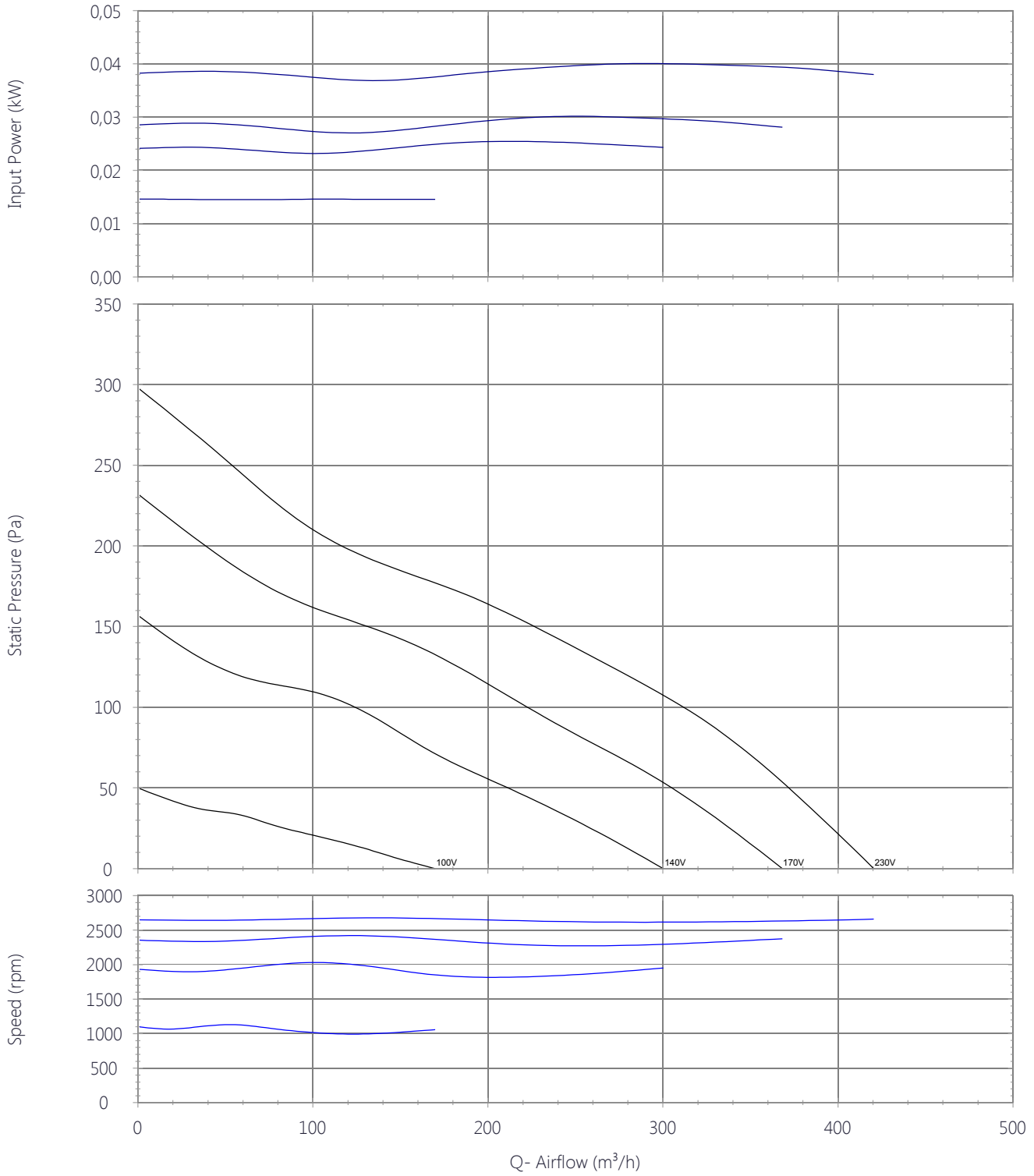

Drawing

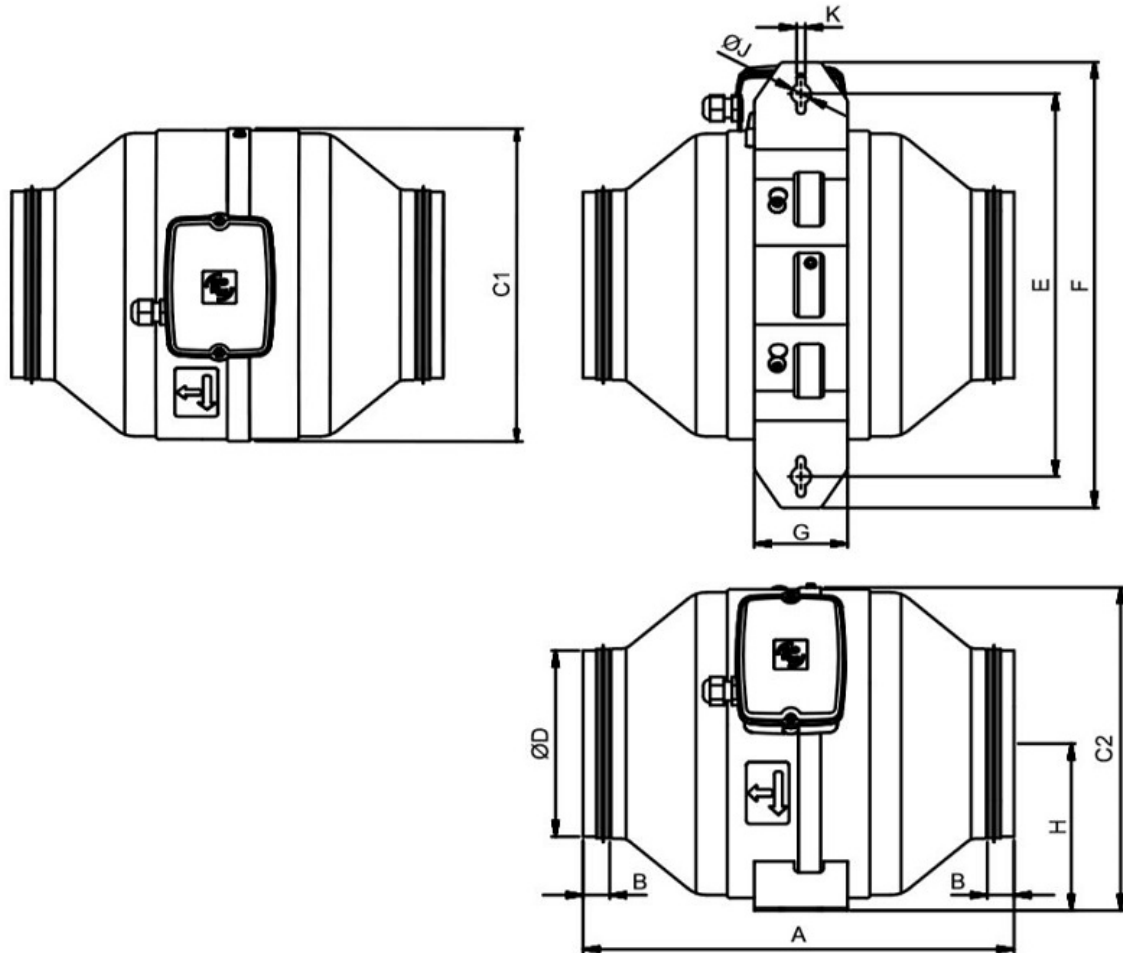

A	B	C1	C2	øD	E	F	G	H	øJ	K
279	15	206	214	120	265	315	70	111	15	6.5

Accessories

5211808400 - MBE-125/04B 1/230V



Electric Heater Battery

Dimensions

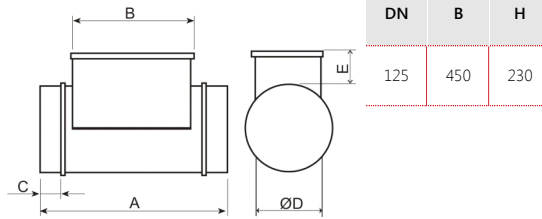

5211801500 - MBE-125/12B



Electric Heater Battery

Dimensions

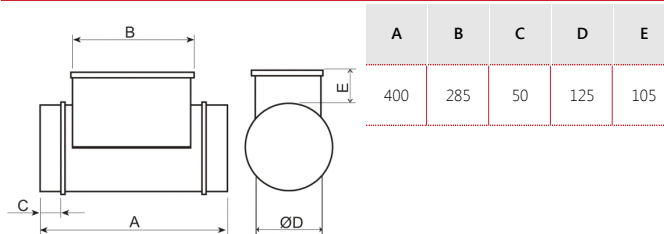

5211781200 - MBE-125/04B-R 1/230V



Electric Heater Battery

Dimensions

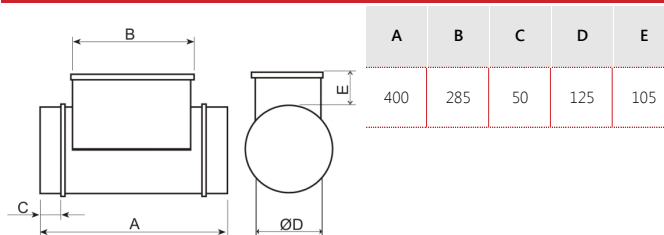

5211808500 - MBE-125/08B 1/230V



Electric Heater Battery

Dimensions

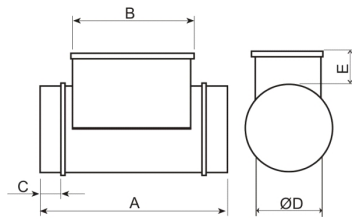

A	B	C	D	E
400	285	50	125	105

5211781300 - MBE-125/08B-R 1/230V



Electric Heater Battery

Dimensions

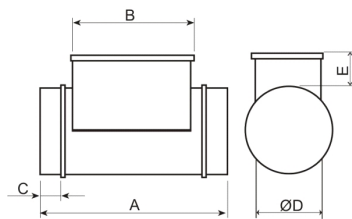

A	B	C	D	E
400	285	50	125	105

5211781400 - MBE-125/12B-R 1/230V



Electric Heater Battery

Dimensions

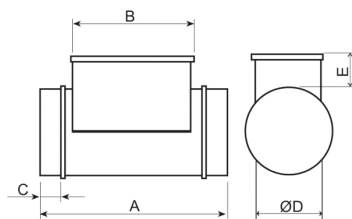

A	B	C	D	E
400	285	50	125	105

5132864100 - MBW-125

Hot-water coil

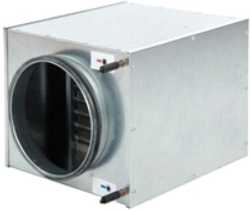

Dimensions

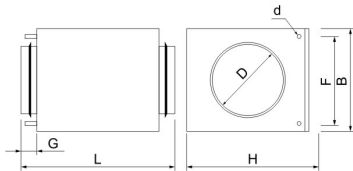

B	D	H	J	K	L	R
183	125	225	40	140	380	10

5416744700 - MFL-125 F

Box in galvanized steel for inserting the MFR F5, F6 and F7 filters. Fitted with inlet and discharge circular duct connection flanges with integrated rubber air seal and an inspection cover easy to open for maintaining the filters.

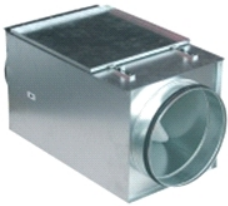

Dimensions

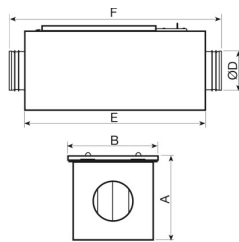

A	B	D	E	F
213	220	125	450	522

5416591500 - MFL-125 G4

MFL filtration boxes are of G4 grade filtration and are designed for direct connection with standard circular ducting. The MFL-G4 filtration boxes are supplied with a cover easily removable to replace the filter.



Dimensions

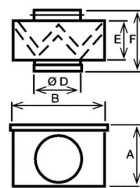

A	B	D	E	d
206	229	125	154	218



JETLINE

5145895700 - JETLINE-125 (220/240V50/60HZ) N8 - IN LINE DUCT FANS

5145801600 - DEF-VENT-125



OUTLET WIRE PROTECTION GUARD

Dimensions

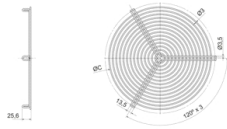

NW

125

5211809800 - SIL-125

Silencer to be installed either at the inlet or outlet of the fan.



Corrections

63	125	250	500	1k	2k	4k	8k
-1	-3	-9	-20	-28	-35	-28	-13

Dimensions

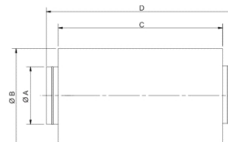

A	B	C	D
125	225	600	700

5145820600 - ACOP-VENT-125 (V977502)



FLEXIBLE CONNECTOR



JETLINE

5145895700 - JETLINE-125 (220/240V50/60HZ) N8 - IN LINE DUCT FANS

Sound Performance

	63	125	250	500	1k	2k	4k	8k	Overall
Inlet (LwA)	41	38	52	63	55	56	52	43	65
Inlet LpA @ 1m	30	27	41	52	44	45	41	32	54
Outlet (LwA)	29	45	52	61	56	56	54	41	64
Outlet LpA @ 1m	18	34	41	50	45	45	43	30	53
Breakout (LwA)	31	25	27	37	34	35	33	25	42
Breakout LpA @ 1m	20	14	16	26	23	24	22	14	31





ErP Data

Ecodesign	
Commission regulation (EU) N°1253/2014 of July 2014	
Information requirements (Annex V)	
Product description	JETLINE-125 (220/240V50/60HZ) N8
Manufacturer's Info	S&P ES-08150 CIF-B64911928
Identifier	-
Typology	NRVU unidirectional
Drive	VSD
Type of HRC	None
Thermal efficiency (%)	NA
Qnom (m3/s)	0,07
Pelec (kW)	0,04
SFPint (W/m3/s)	NA
Face velocity (m/s)	2,25
$\Delta p_{s,ext}$ (Pa)	145,38
$\Delta p_{s,int}$ (Pa)	NA
$\Delta p_{s,add}$ (Pa)	NA
Static efficiency fans (%)	24,1
External leakage rate (%)	0,1
Internal leakage rate (%)	NA
Filter performance	NA
Filter warning	NA
LWA dB(A)	41
https://www.solerpalau.com/	