

RTRE 3 Speed control

Item Number: 5009

Variant: 230V 1~ 50/60Hz

Manual five-step transformer (with motor protection)

A single-phase transformer which controls the fan speed by altering the supply voltage in five fixed steps. The steps are adjusted manually, using the control knob on the front of the unit. An integral motor protection device is included which cuts the supply voltage to the fan if the thermal contact in the fan motor is activated. The unit is reset by turning the knob to "0" for 10 seconds, after which the unit restarts.

The unit has input terminals for room thermostat RT, which stops the supply voltage to the fan when the circuit is broken. These terminals are linked before delivery. The transformer has 230V terminals for operating dampers, electric water-heater batteries or other external equipment. These terminals have no current when the transformer knob is in position 0, or when the TK or RT input is open. The indicator lamp on the front shows when the transformer is in operation. The fuse may be reset from outside. The RTRE has a self-extinguishing thermoplastic casing. Supply voltage: 230V 50/60Hz.



Technical parameters

Nominal data		
Voltage (nominal)	230	V
Frequency	50; 60	Hz
Phase(s)	1~	
Input current	3	A
Protection/Classification		
Enclosure class	IP54	
Dimensions and weights		
Depth	106	mm
Height	203	mm
Width	105	mm
Weight	2.8	kg

Dimension

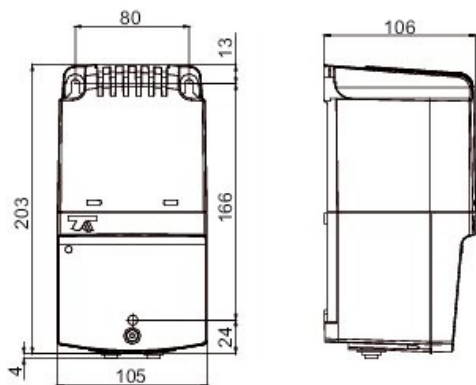

Wiring

RTRE 1,5 RTRE 3 RTRE 5

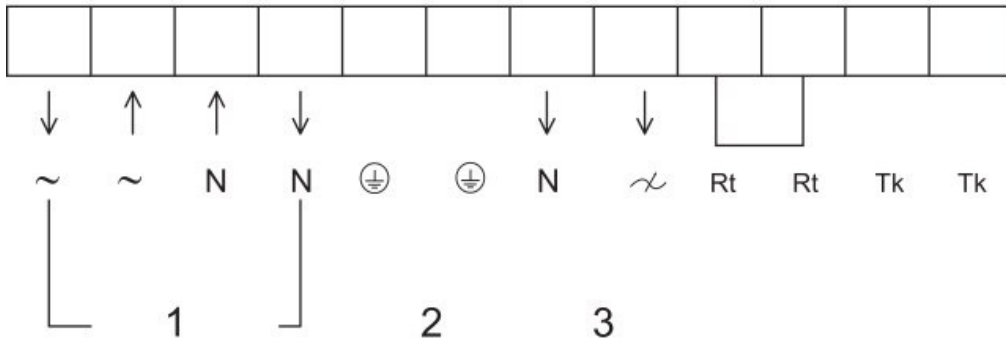

Transmission: between ~ and N is always 230V when the transformer handle is in pos. 1-5

Documents

- RE_RTRE_REU_IMO_GB.PDF
- DECLARATION OF CONFORMITY_RE_REU_RTRE_EN-2017.PDF