



TD-SILENT ECOWATT

5211988100 - TD-1300/250 SILENT ECOWATT (230V50/60HZ) VE - IN-LINE DUCT FANS



Low profile "Mixed-flow" fans (models 1300 and 2000) with sound-absorbent insulation, extremely quiet, manufactured from heavy gauge sheet steel protected by a tough epoxy polyester paint coating, acoustic insulation (MO) glass fiber, outer shell and aerodynamic inlet to improve airflow and reduce sound. A body that can be removed without dismantling the adjacent ducting and therefore facilitating any installation or maintenance. Brushless EC motor, high efficiency and low consumption, suitable for single phase supply 230V±15%/50-60Hz, IP44, class B, thermal overload protection. Fan speed 100% adjustable with the potentiometer placed in the connection box or with an external control type REB- ECOWATT. Analogue input with terminals in the terminal box to control the fan with 0-10V input signal. Models are suitable for mounting in any orientation and operation within ambient air temperatures between -20°C up to +40°C. Suitable for any kind of ventilation application where the noise level of the ventilation system is of particular importance and, due to continuous operation, a significant energy saving is desirable. It is also suitable for applications that require a Demand Controlled Ventilation System involving the use of other sensors or controls. Brand S&P model TD-1300/250 SILENT ECOWATT (230V50/60HZ) VE.

5211988100 - TD-1300/250 SILENT ECOWATT (230V50/60HZ) VE

Theoretical Working Point

Airflow	-
Static Pressure	0,000 Pa
Temperature	20 °C
Altitude	0 m
Density	1,2 kg/m ³
Frequency	50/60 Hz
Voltage	1-230V-50Hz

Construction

Discharge diameter	250 mm
Fan size	250
Weight	9,50 kg

Motor Characteristics

Voltage	1-230V-50Hz
Maximum absorbed current	0,6 A
IP Rating	IP44
Motor insulation class	B

Drawing

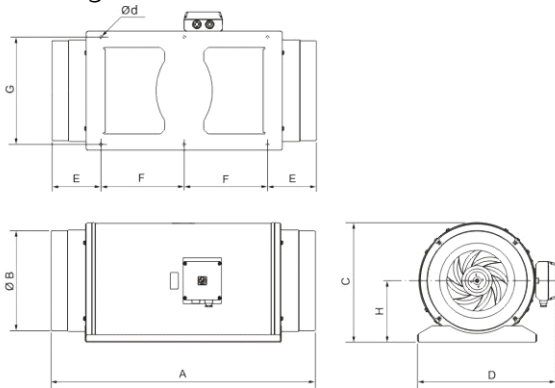

A	B	C	D	E	F	G	H	d
680	248	331	387	140	200	280	171	8.5

Performance Chart

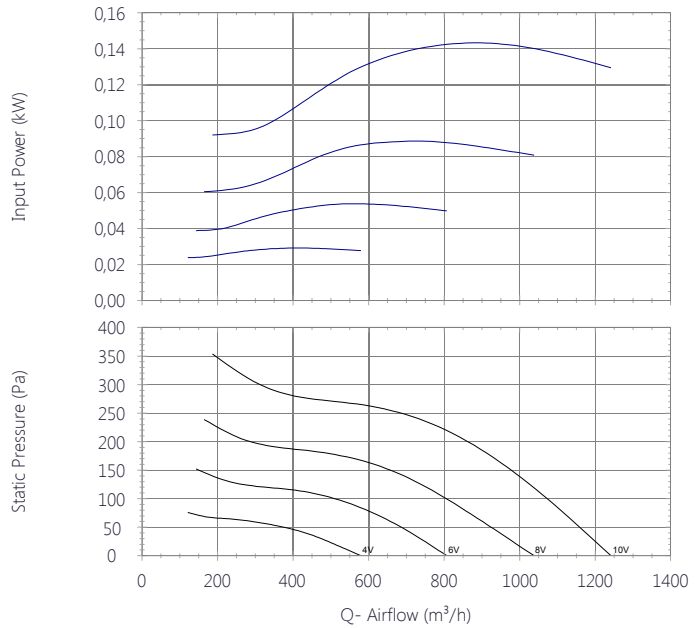

Sound Performance

	63	125	250	500	1k	2k	4k	8k	Overall
Inlet (LwA)	29	42	60	58	62	60	56	48	67
Inlet LpA @ 1m	18	31	49	47	51	49	45	37	56
Outlet (LwA)	35	45	61	67	72	65	55	45	74
Outlet LpA @ 1m	24	34	50	56	61	54	44	34	63
Breakout (LwA)	21	29	43	48	51	47	39	36	54
Breakout LpA @ 1m	10	18	32	37	40	36	28	25	43





TD-SILENT ECOWATT

5211988100 - TD-1300/250 SILENT ECOWATT (230V50/60HZ) VE - IN-LINE DUCT FANS

Performance Chart

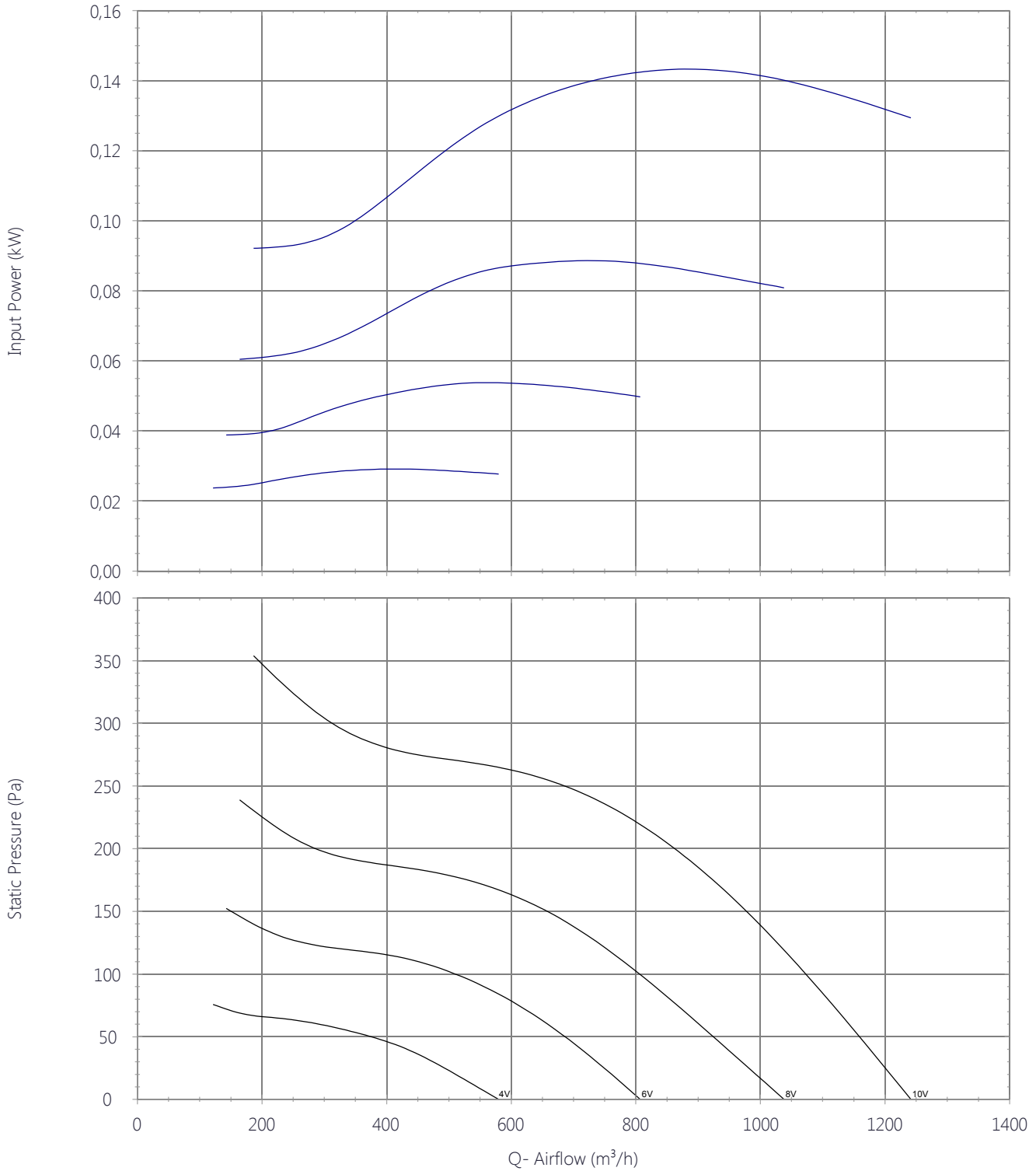



TD-SILENT ECOWATT

5211988100 - TD-1300/250 SILENT ECOWATT (230V50/60HZ) VE - IN-LINE DUCT FANS

Drawing

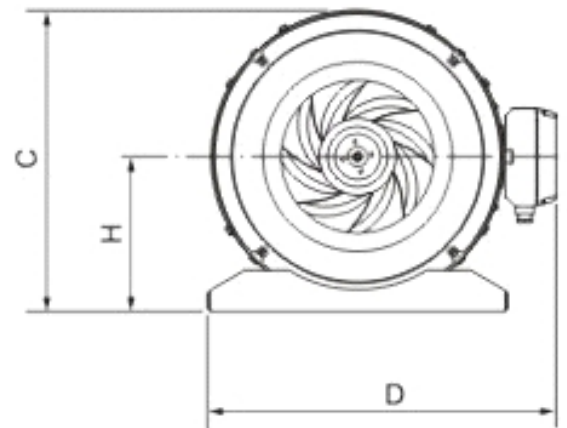
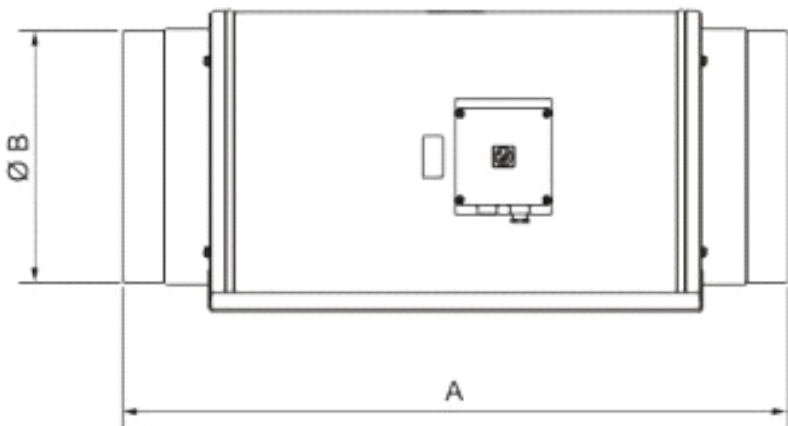
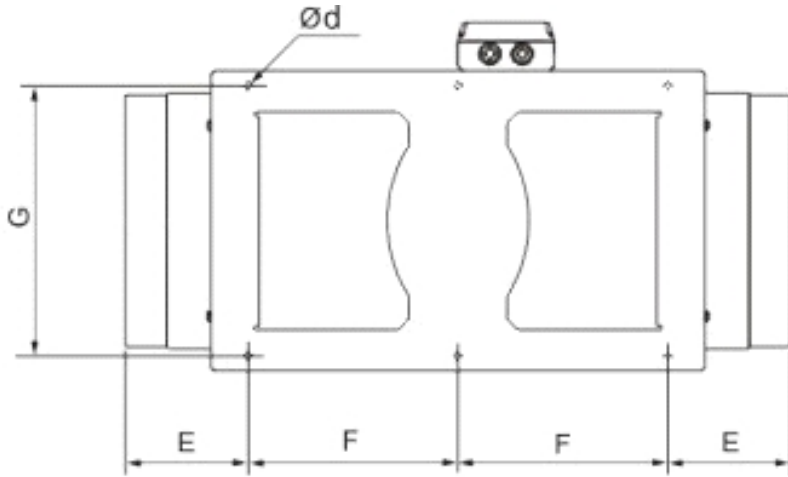

A	B	C	D	E	F	G	H	d
680	248	331	387	140	200	280	171	8.5

Accessories

5401613800 - CONTROL ECOWATT AC/DC (90-260Vac 50y60HZ)



Control element for demand controlled ventilation systems in public, commercial residential building it automatically modifies the fan speed to adapt it to the needs defined in the system, measured with sensors. It has three basic modes of operation: 1. Integral proportional control at constant pressure. 2. Proportional control with maximum demand criteria with multiple sensor input: temperature, CO2 and relative humidity. 3. Minimum-maximum control with three-sensor input: CO2, temperature, relative humidity or presence detectors (PIR). DC signal output of 1 to 10 V or signal output for AC voltage variation for single phase motors at 230 V. ECOWATT C CONTROL: for single phase ventilation units. ECOWATT C CONTROL: for DC ventilation units . Power supply:- AC model: 1~230 V. - DC model: 1~230 V or 24 VDC..

Dimensions

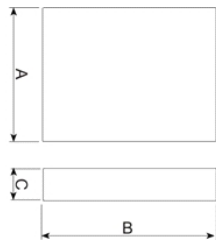

B	H	T
165	220	110

5401637300 - CONTROL ECOWATT BASIC



5416730700 - CPFL-E

Presence detector for ceiling mount, sensitive to infrared radiation emitted by bodies in movement, with a 360° detecting angle. Power supply: 1-230 V.CPFL-E: Flush mount model.



Dimensions

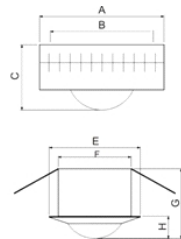

A	B	C	E	F	G	H
105	87	55	90	72	69	22

5416730600 - CPFL-S

Presence detector for ceiling mount, sensitive to infrared radiation emitted by bodies in movement, with a 360° detecting angle. Power supply: 1-230 V. CPFL-S: Surface model.



Dimensions

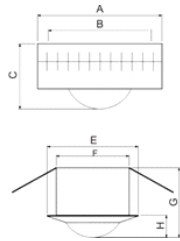

A	B	C	E	F	G	H
105	87	55	90	72	69	22

5211782600 - MBE-250/20T-R 2/400V

Electric Heater Battery



Dimensions

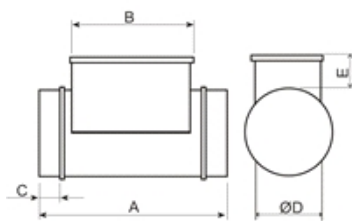

A	B	C	D	E
400	285	50	250	105

5211782700 - MBE-250/30T-R 2/400V

Electric Heater Battery



Dimensions

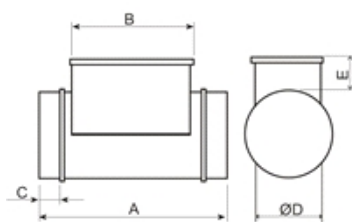

A	B	C	D	E
400	285	50	250	105



TD-SILENT ECOWATT

5211988100 - TD-1300/250 SILENT ECOWATT (230V50/60HZ) VE - IN-LINE DUCT FANS

5211782800 - MBE-250/40T-R 2/400V



Electric Heater Battery

Dimensions

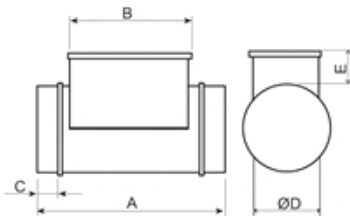

A	B	C	D	E
400	285	50	250	105

5211782900 - MBE-250/50T-R2/400V



Electric Heater Battery

Dimensions

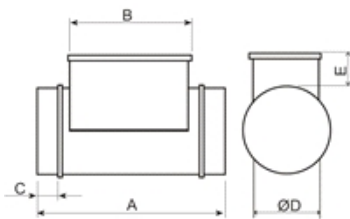

A	B	C	D	E
400	285	50	250	105

5211783000 - MBE-250/60T-R 2/400V



Electric Heater Battery

Dimensions

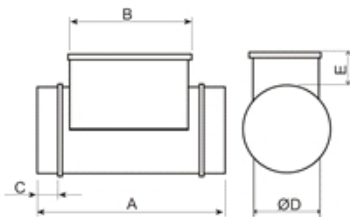

A	B	C	D	E
400	285	50	250	105



TD-SILENT ECOWATT

5211988100 - TD-1300/250 SILENT ECOWATT (230V50/60HZ) VE - IN-LINE DUCT FANS

5211783100 - MBE-250/90T-R 3/400V



Electric Heater Battery

Dimensions

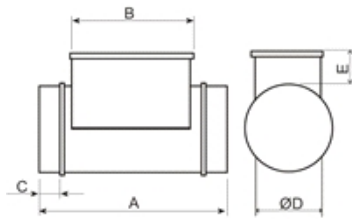

A	B	C	D	E
400	285	50	250	105

5416580800 - MFL-250 G4



MFL filtration boxes are of G4 grade filtration and are designed for direct connection with standard circular ducting. The MFL-G4 filtration boxes are supplied with a cover easily removable to replace the filter.

Dimensions

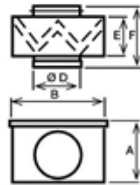

A	B	D	E	F
296	319	250	154	248

5418061600 - MPC-250 S



Flow detectors designed to correctly measure pressures at the inlet of series TD devices with airflow straightener.

Dimensions

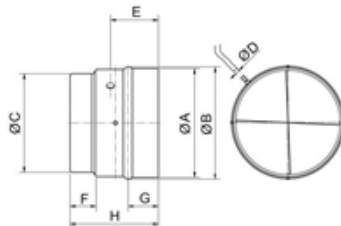

A	B	C	D	E	F	G	H
108	108.7	94.5	6	58	31.5	36.5	105.5



TD-SILENT ECOWATT

5211988100 - TD-1300/250 SILENT ECOWATT (230V50/60HZ) VE - IN-LINE DUCT FANS

5401304100 - REB-CVF (0-10V)



5401304000 - REB-ECOWATT (0-10V)

Electronic voltage regulator



Dimensions

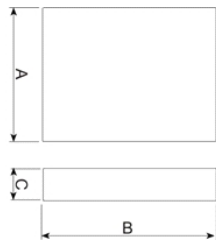

B	H	T
80	80	68

5416730100 - REMP-250

Motorized shutter



Dimensions

D	axle	L	MH
250	8	200	80



TD-SILENT ECOWATT

5211988100 - TD-1300/250 SILENT ECOWATT (230V50/60HZ) VE - IN-LINE DUCT FANS

5416731100 - SHT-AD



SHT-AD: Ambient CO2 sensor, temperature and relative humidity with display.

Dimensions

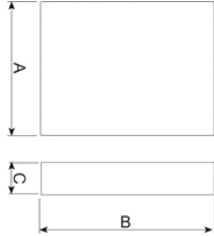

A	B	C
85	26	100

5416730800 - SCO2-A



SCO2-A: Ambient CO2 and temperature sensor.

Dimensions

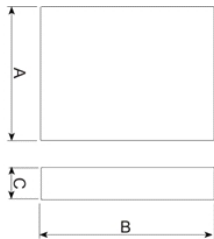

A	B	C
85	26	100

5401221000 - SCO2-A 0/10V



SCO2-A: Ambient CO2 and temperature sensor.

Dimensions

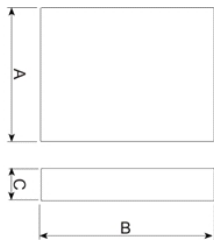

B	H	T
11	130	65



TD-SILENT ECOWATT

5211988100 - TD-1300/250 SILENT ECOWATT (230V50/60HZ) VE - IN-LINE DUCT FANS

5416730900 - SCO2-AD

SCO2-AD: Ambient CO2 and temperature sensor with display.



Dimensions

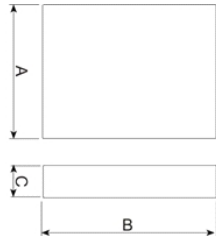

B	H	T
11	130	65

5211812200 - SIL-250

Silencer to be installed either at the inlet or outlet of the fan.



Corrections

63	125	250	500	1k	2k	4k	8k
-0	-2	-7	-12	-18	-23	-10	-5

Dimensions

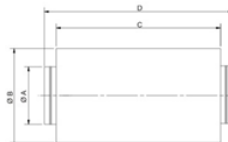

A	B	C	D
250	355	600	700

5416731400 - TDP-D

TDP-D: Pressure sensor, with display. Enables you to control the pressure in the fan inlet.



Dimensions

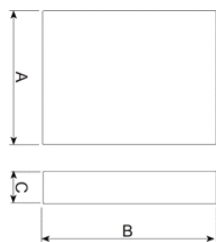

B	H	T
11	130	65



TD-SILENT ECOWATT

5211988100 - TD-1300/250 SILENT ECOWATT (230V50/60HZ) VE - IN-LINE DUCT FANS

5416731300 - TDP-S



TDP-S: Pressure sensor. Enables you to control the pressure in the fan inlet.

Dimensions

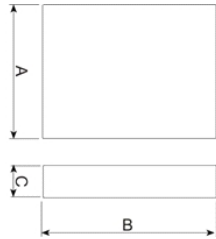

A	B	C
75	80	36



TD-SILENT ECOWATT

5211988100 - TD-1300/250 SILENT ECOWATT (230V50/60HZ) VE - IN-LINE DUCT FANS

Sound Performance

	63	125	250	500	1k	2k	4k	8k	Overall
Inlet (LwA)	29	42	60	58	62	60	56	48	67
Inlet LpA @ 1m	18	31	49	47	51	49	45	37	56
Outlet (LwA)	35	45	61	67	72	65	55	45	74
Outlet LpA @ 1m	24	34	50	56	61	54	44	34	63
Breakout (LwA)	21	29	43	48	51	47	39	36	54
Breakout LpA @ 1m	10	18	32	37	40	36	28	25	43





TD-SILENT ECOWATT

5211988100 - TD-1300/250 SILENT ECOWATT (230V50/60HZ) VE - IN-LINE DUCT FANS

ErP Data

Ecodesign	
Commission regulation (EU) N°1253/2014 of July 2014	
Information requirements (Annex V)	
Product description	TD-1300/250 SILENT ECOWATT (230V50/60HZ) VE
Manufacturer's Info	S&P ES-08150 CIF-B64911928
Identifier	5211988100
Typology	NRVU unidirectional
Drive	VSD
Type of HRC	None
Thermal efficiency (%)	NA
Qnom (m3/s)	0,21
Pelec (kW)	0,14
SFPint (W/m3/s)	NA
Face velocity (m/s)	4,22
$\Delta p_{s,ext}$ (Pa)	236,9
$\Delta p_{s,int}$ (Pa)	NA
$\Delta p_{s,add}$ (Pa)	NA
Static efficiency fans (%)	40
External leakage rate (%)	5
Internal leakage rate (%)	NA
Filter performance	NA
Filter warning	NA
LWA dB(A)	53
https://www.solerpalau.com/	