



Range of roof mounted mixed flow fans supplied as standard for extract operation. The models 500 and 800 are manufactured from high strength injection moulded plastic, and models 1300 and 2000 from high grade pressed sheet steel. The bases are manufactured from sheet steel. The cowls are manufactured from pressed sheet steel (500 and 800 models) or spun aluminium (1200 and 2000). All models incorporate a bird guard and base cable gland entry point as standard. All metallic parts are protected with a black epoxy-polyester weatherproof paint coating. The motor and impeller casing can be easily removed by 2 fixing clamps.

Motors

All motors are IP44, Class F, equipped with thermal protection and ball bearings greased for life.

Electrical supply:

Single phase 230V-50Hz (Capacitor located inside the wiring terminal box).

All motor have three speed connections also suitable for voltage speed control using electronic or auto-transformer controllers.

Additional information

Supplied, in the standard version, as extractors. For the TH-500, 800 and 800N models, the motor and impeller casing can be removed and turned through 180° to provide supply air ventilation.



Flame retardant terminal box

Very accessible wiring terminal box in flame retardant plastic V0, with capacitor located inside.

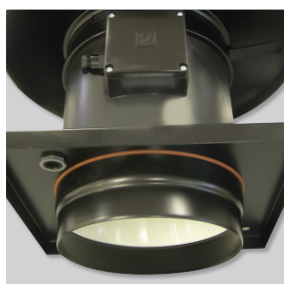

Circular spigot coupling

Circular spigot coupling to facilitate the connection of circular, rigid or flexible ducting.



Bird-proof guard.



TECHNICAL CHARACTERISTICS

Before installation check that the product electrical characteristics listed on the data plate label (voltage, power, frequency, etc.) match those of the intended electrical supply.

Model		Speed (RPM)	Maximum absorbed power (W)	Maximum absorbed current (A)	Maximum airflow (m³/h)	Sound pressure level* (dB(A))		Min-Max air temperature (°C)	Weight (kg)	3-speed switch	Speed controller	Wiring diagram (n°)**
						Inlet	Outlet					
TH-500/150 3V TH-500/160 3V	EXTRACT	2560	54	0,23	500	46	50	-20/+60	3,8	COM-3 INTER 4P	RMB-1,5 REB-1	53, 54
		2120	43	0,19	420	43	46					
		1790	41	0,18	360	38	42					
	SUPPLY	2540	63	0,27	530	48	47					
		2170	53	0,22	460	44	43					
TH-800N 3V	EXTRACT	2210	101	0,49	720	47	52	-20/+60	5,6	COM-3 INTER 4P	RMB-1,5 REB-1	53, 54
		1900	94	0,47	620	44	49					
		1720	92	0,46	540	42	46					
	SUPPLY	2220	105	0,45	830	50	52					
		1920	93	0,42	710	47	49					
TH-800 3V	EXTRACT	2380	117	0,51	790	48	52	-20/+60	5,6	COM-3 INTER 4P	RMB-1,5 REB-1	53, 54
		2110	108	0,49	680	46	50					
		1940	105	0,47	610	44	48					
	SUPPLY	2390	136	0,56	890	52	54					
		2110	129	0,53	780	49	51					
TH-1300 3V	EXTRACT	2480	192	0,81	1060	54	60	-40/+60	11,2	COM-3 INTER 4P	RMB-1,5 REB-1	55, 56
		2140	152	0,63	910	51	57					
		1920	133	0,55	800	49	55					
TH-2000 3V	EXTRACT	2530	301	1,14	1570	57	67	-40/+60	17,2	COM-3 INTER 4P	RMB-1,5 REB-2,5	55, 56
		2250	231	0,89	1390	55	65					
		1960	183	0,71	1220	51	62					

* Sound pressure levels measured at 3 m in free field condition at a medium working point of the performance curve

** See section of Wiring Diagrams.

DIMENSIONS (mm)

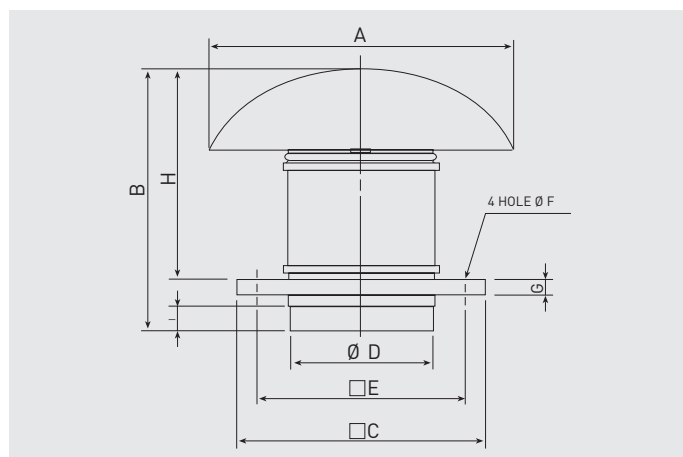

Model	A	B	C	D	E	F	G	H	I
TH-500/150	400	349	300	150	245	10	20	274	33
TH-500/160	400	339	300	160	245	10	20	274	33
TH-800 N	400	371	300	198	245	10	20	306	36
TH-800	400	371	300	198	245	10	20	306	36
TH-1300	546	457	435	248	330	12	20	372	42
TH-2000	735	544	560	312	450	12	20	450	50

PERFORMANCE CURVES - EXTRACT OPERATION

- q_v : Air volume in m^3/h .
- p_{sf} : Static pressure in Pa.
- Dry air at 20°C and 760 mmHg.
- Performance data in accordance with ISO 5801 and AMCA 210-99 Standards.
- SFP: Specific fan power in $W/m^3/s$ (blue curves).

HS: High Speed
MS: Medium Speed
LS: Low Speed

TH-500/150 3V
TH-500/160 3V

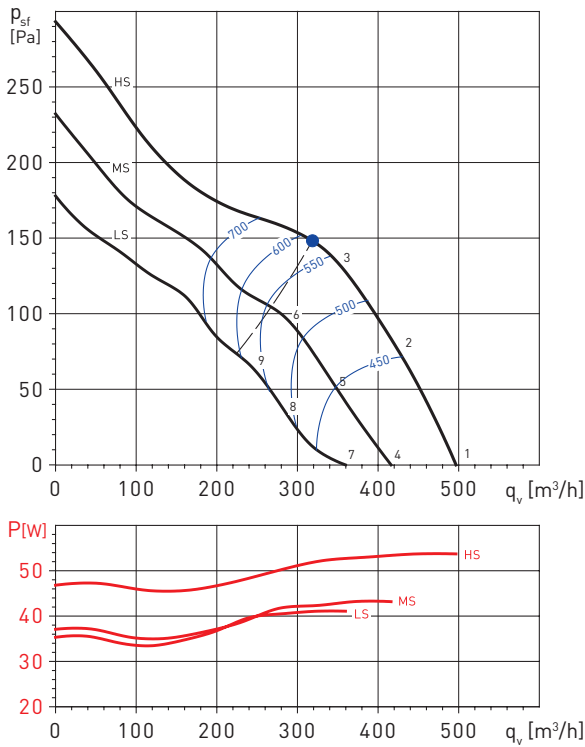

TH-800 N 3V

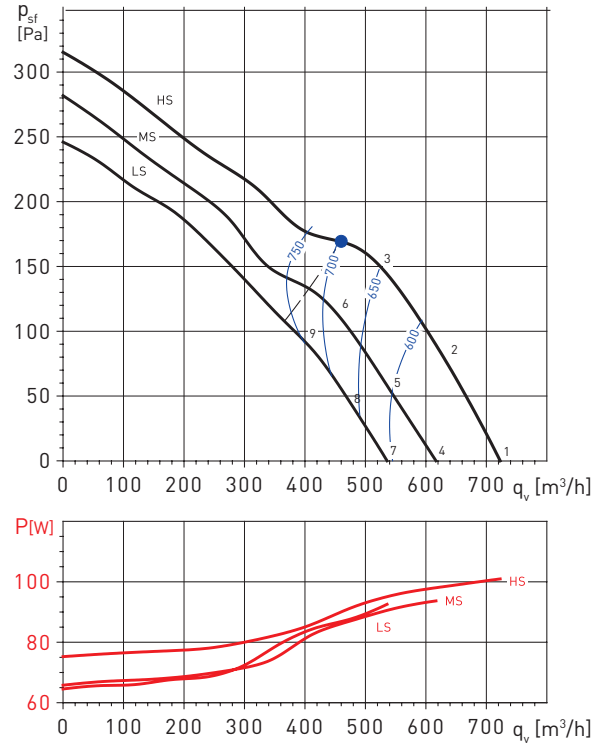

Sound power level spectrums in dB(A)

Working point		63	125	250	500	1.000	2.000	4.000	8.000	LwA
1	Inlet	35	42	58	64	63	62	57	48	69
	Outlet	36	44	60	68	68	64	58	48	72
2	Inlet	35	41	55	63	61	60	55	47	67
	Outlet	36	42	60	67	66	62	55	46	71
3	Inlet	35	41	61	64	61	59	55	47	68
	Outlet	35	42	61	68	65	61	55	46	71
4	Inlet	31	38	54	60	59	58	53	44	65
	Outlet	32	40	56	64	64	60	54	44	68
5	Inlet	31	37	51	59	57	56	51	43	63
	Outlet	32	38	56	63	62	58	51	42	67
6	Inlet	31	37	57	60	57	55	51	43	64
	Outlet	31	38	57	64	61	57	51	42	67
7	Inlet	27	34	50	56	55	54	49	40	61
	Outlet	28	36	52	60	60	56	50	40	65
8	Inlet	27	33	47	55	53	52	47	39	59
	Outlet	28	34	52	59	58	54	47	38	63
9	Inlet	27	33	53	56	53	51	47	39	60
	Outlet	27	34	53	60	57	53	47	38	63

Sound power level spectrums in dB(A)

Working point		63	125	250	500	1.000	2.000	4.000	8.000	LwA
1	Inlet	40	46	58	65	60	62	57	49	68
	Outlet	41	50	62	68	68	66	60	51	73
2	Inlet	37	44	55	62	60	63	57	50	67
	Outlet	38	47	60	68	68	64	58	49	72
3	Inlet	34	44	57	67	63	65	58	51	71
	Outlet	34	45	57	69	70	63	57	47	73
4	Inlet	37	43	55	62	57	59	54	46	65
	Outlet	38	47	59	65	65	63	57	48	69
5	Inlet	34	41	52	59	57	60	54	47	64
	Outlet	35	44	57	65	65	61	55	46	69
6	Inlet	31	41	54	64	60	62	55	48	68
	Outlet	31	42	54	66	67	60	54	44	70
7	Inlet	34	40	52	59	54	56	51	43	63
	Outlet	35	44	56	62	62	60	54	45	67
8	Inlet	32	39	50	57	55	58	52	45	62
	Outlet	33	42	55	63	63	59	53	44	67
9	Inlet	29	39	52	62	58	60	53	46	66
	Outlet	29	40	52	64	65	58	52	42	68

PERFORMANCE CURVES – EXTRACT OPERATION

- q_v : Air volume in m^3/h .
- p_{sf} : Static pressure in Pa.
- Dry air at 20°C and 760 mmHg.
- Performance data in accordance with ISO 5801 and AMCA 210-99 Standards.
- SFP: Specific fan power in $W/m^3/s$ (blue curves).

HS: High Speed
MS: Medium Speed
LS: Low Speed

TH-800 3V

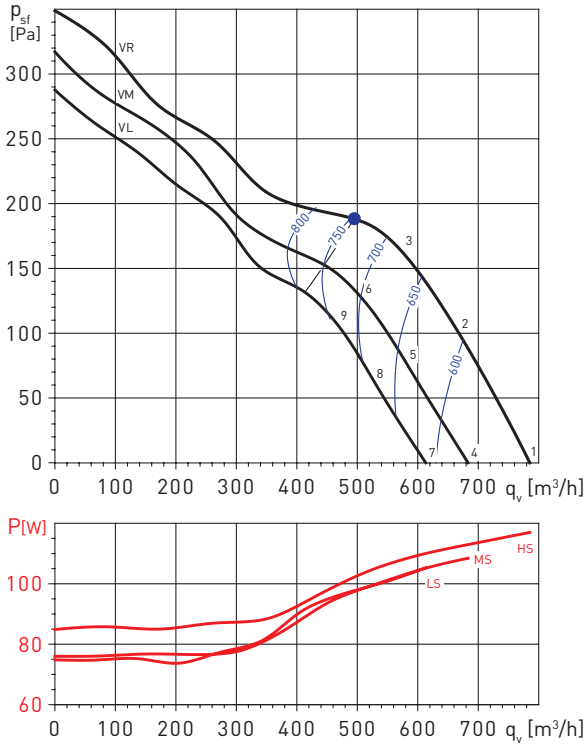

TH-1300 3V

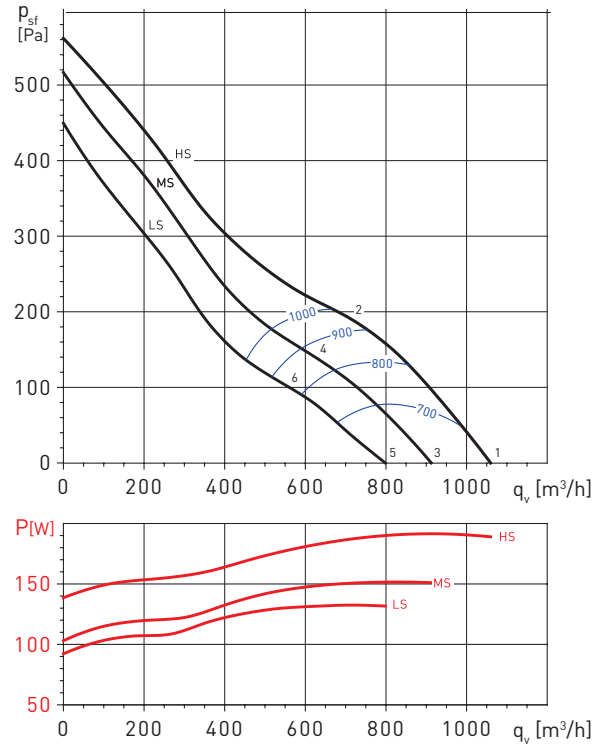

Sound power level spectrums in dB(A)

Working point		63	125	250	500	1.000	2.000	4.000	8.000	LwA
1	Inlet	41	50	60	66	61	64	60	52	70
	Outlet	43	52	64	71	70	66	63	54	75
2	Inlet	38	49	56	63	62	64	59	52	69
	Outlet	39	49	61	68	69	65	60	51	73
3	Inlet	34	48	55	67	63	65	59	53	71
	Outlet	35	48	57	70	71	64	59	49	74
4	Inlet	38	47	57	63	58	61	57	49	67
	Outlet	40	49	61	68	67	63	60	51	72
5	Inlet	35	46	53	60	59	61	56	49	66
	Outlet	36	46	58	65	66	62	57	48	70
6	Inlet	32	46	53	65	61	63	57	51	68
	Outlet	33	46	55	68	69	62	57	47	72
7	Inlet	36	45	55	61	56	59	55	47	65
	Outlet	38	47	59	66	65	61	58	49	70
8	Inlet	34	45	52	59	58	60	55	48	64
	Outlet	35	45	57	64	65	61	56	47	69
9	Inlet	30	44	51	63	59	61	55	49	67
	Outlet	31	44	53	66	67	60	55	45	70

Sound power level spectrums in dB(A)

Working point		63	125	250	500	1.000	2.000	4.000	8.000	LwA
1	Inlet	38	46	59	60	71	69	63	59	74
	Outlet	42	49	65	71	77	75	66	59	80
2	Inlet	38	48	63	60	69	67	61	57	72
	Outlet	39	49	67	71	74	72	64	56	78
3	Inlet	35	43	56	57	68	66	60	56	71
	Outlet	39	46	62	68	74	72	63	56	77
4	Inlet	36	46	61	58	67	65	59	55	70
	Outlet	37	47	65	69	72	70	62	54	75
5	Inlet	33	41	54	55	66	64	58	54	69
	Outlet	37	44	60	66	72	70	61	54	75
6	Inlet	33	43	58	55	64	62	56	52	68
	Outlet	34	44	62	66	69	67	59	51	73

PERFORMANCE CURVES – EXTRACT OPERATION

- q_v : Air volume in m^3/h .
- p_{sf} : Static pressure in Pa.
- Dry air at $20^\circ C$ and 760 mmHg.
- Performance data in accordance with ISO 5801 and AMCA 210-99 Standards.
- SFP: Specific fan power in $W/m^3/s$ (blue curves).

HS: High Speed
MS: Medium Speed
LS: Low Speed

TH-2000 3V

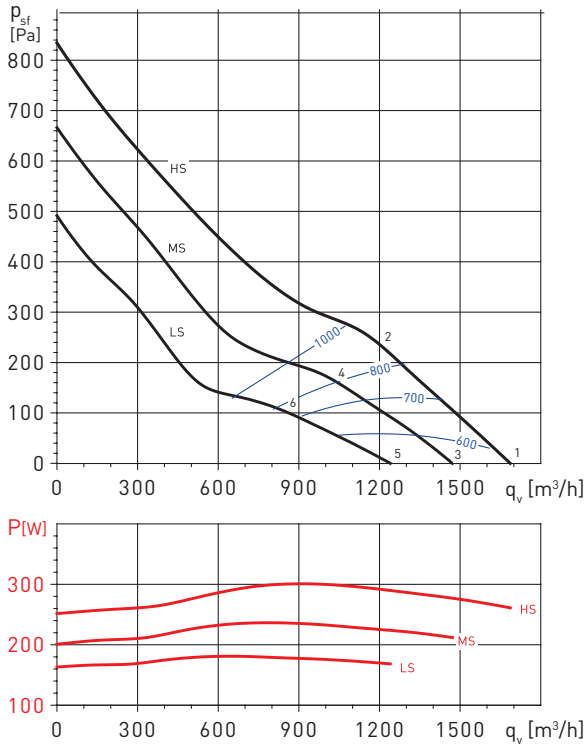

Sound power level spectrums in dB(A)

Working point		63	125	250	500	1.000	2.000	4.000	8.000	LwA
1	Inlet	38	47	60	64	74	73	65	59	77
	Outlet	42	52	70	74	87	74	68	59	88
2	Inlet	37	51	70	62	71	71	63	57	76
	Outlet	38	55	74	72	74	74	65	57	80
3	Inlet	36	45	58	62	72	71	63	57	75
	Outlet	40	50	68	72	85	72	66	57	86
4	Inlet	33	47	66	58	67	67	59	53	72
	Outlet	34	51	70	68	70	70	61	53	76
5	Inlet	33	42	55	59	69	68	60	54	72
	Outlet	37	47	65	69	82	69	63	54	82
6	Inlet	29	43	62	54	63	63	55	49	68
	Outlet	30	47	66	64	66	66	57	49	72

PERFORMANCE CURVES – SUPPLY OPERATION

- q_v : Air volume in m^3/h .
- p_{sf} : Static pressure in Pa.
- Dry air at $20^\circ C$ and 760 mmHg .
- Performance data in accordance with ISO 5801 and AMCA 210-99 Standards.
- SFP: Specific fan power in $W/m^3/s$ (blue curves).

HS: High Speed
MS: Medium Speed
LS: Low Speed

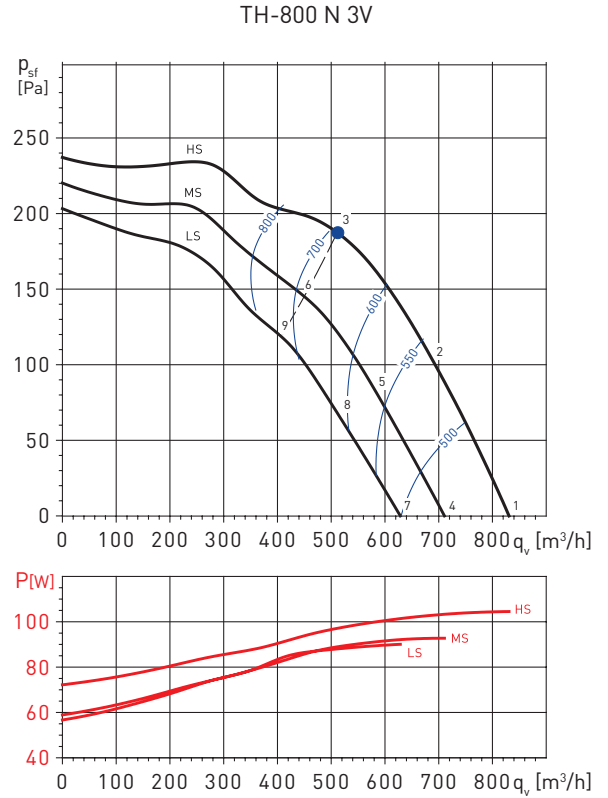
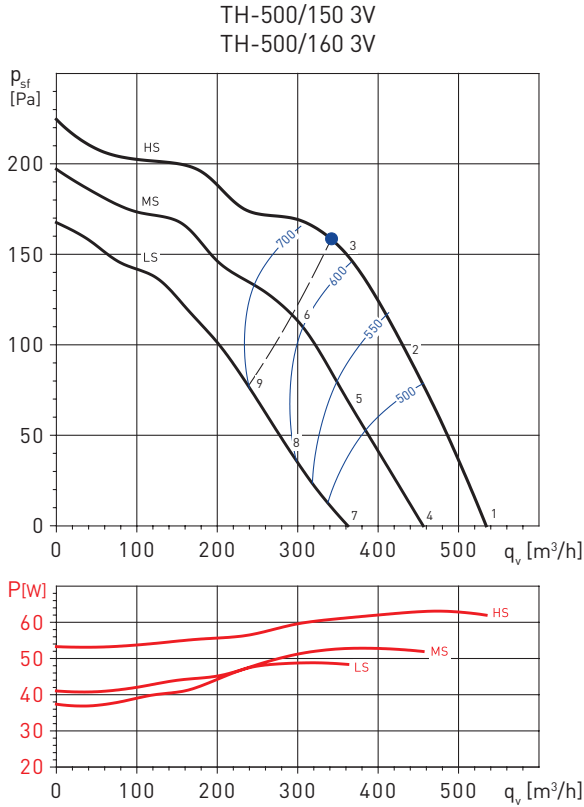

Sound power level spectrums in dB(A)

Working point		63	125	250	500	1.000	2.000	4.000	8.000	LwA
1	Inlet	30	41	60	66	67	63	55	46	71
	Outlet	34	41	59	64	65	62	58	51	69
2	Inlet	32	40	59	63	64	60	52	43	68
	Outlet	34	39	58	62	63	58	56	48	67
3	Inlet	33	40	58	63	64	60	57	44	68
	Outlet	34	39	58	63	63	58	57	48	68
4	Inlet	26	37	56	62	63	59	51	42	67
	Outlet	31	38	56	61	62	59	55	48	66
5	Inlet	28	36	55	59	60	56	48	39	64
	Outlet	30	35	54	58	59	54	52	44	64
6	Inlet	29	36	54	59	60	56	53	40	64
	Outlet	30	35	54	59	59	54	53	44	64
7	Inlet	22	33	52	58	59	55	47	38	63
	Outlet	26	33	51	56	57	54	50	43	61
8	Inlet	24	32	51	55	56	52	44	35	60
	Outlet	26	31	50	54	55	50	48	40	59
9	Inlet	25	32	50	55	56	52	49	36	61
	Outlet	27	32	51	56	56	51	50	41	60

Sound power level spectrums in dB(A)

Working point		63	125	250	500	1.000	2.000	4.000	8.000	LwA
1	Inlet	35	43	55	65	68	62	56	45	71
	Outlet	36	44	59	68	69	67	61	51	73
2	Inlet	32	40	54	65	68	60	54	45	70
	Outlet	33	41	57	67	68	65	60	50	72
3	Inlet	33	43	56	67	69	61	54	45	72
	Outlet	43	50	61	72	71	66	61	52	75
4	Inlet	32	40	52	62	65	59	53	42	67
	Outlet	33	41	56	65	66	64	58	48	70
5	Inlet	29	37	51	62	65	57	51	42	67
	Outlet	30	38	54	64	65	62	57	47	69
6	Inlet	30	40	53	64	66	58	51	42	69
	Outlet	41	48	59	70	69	64	59	50	73
7	Inlet	29	37	49	59	62	56	50	39	65
	Outlet	31	39	54	63	64	62	56	46	68
8	Inlet	27	35	49	60	63	55	49	40	65
	Outlet	28	36	52	62	63	60	55	45	67
9	Inlet	29	39	52	63	65	57	50	41	67
	Outlet	39	46	57	68	67	62	57	48	71

PERFORMANCE CURVES – SUPPLY OPERATION

- q_v : Air volume in m^3/h .
- p_{st} : Static pressure in Pa.
- Dry air at 20°C and 760 mmHg.
- Performance data in accordance with ISO 5801 and AMCA 210-99 Standards.
- SFP: Specific fan power in $W/m^3/s$ (blue curves).

HS: High Speed
MS: Medium Speed
LS: Low Speed

TH-800 3V

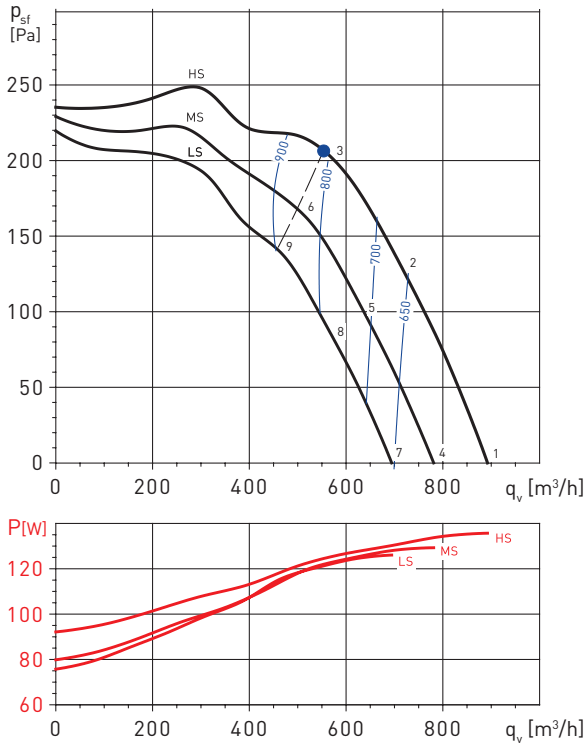

Sound power level spectrums in dB(A)

Working point		63	125	250	500	1.000	2.000	4.000	8.000	LwA
1	Inlet	37	48	56	67	70	63	58	47	73
	Outlet	37	47	58	72	72	69	64	54	76
2	Inlet	33	48	54	66	70	62	56	46	72
	Outlet	34	45	56	69	71	67	62	53	74
3	Inlet	32	48	56	67	71	62	56	47	73
	Outlet	33	47	56	69	72	67	61	53	75
4	Inlet	34	45	53	64	67	60	55	44	70
	Outlet	34	44	55	69	69	66	61	51	74
5	Inlet	30	45	51	63	67	59	53	43	69
	Outlet	31	42	53	66	68	64	59	50	72
6	Inlet	30	46	54	65	69	60	54	45	71
	Outlet	31	45	54	67	70	65	59	51	73
7	Inlet	32	43	51	62	65	58	53	42	67
	Outlet	32	42	53	67	67	64	59	49	71
8	Inlet	28	43	49	61	65	57	51	41	67
	Outlet	29	40	51	64	66	62	57	48	70
9	Inlet	28	44	52	63	67	58	52	43	69
	Outlet	29	43	52	65	68	63	57	49	71

MOUNTING ACCESSORIES

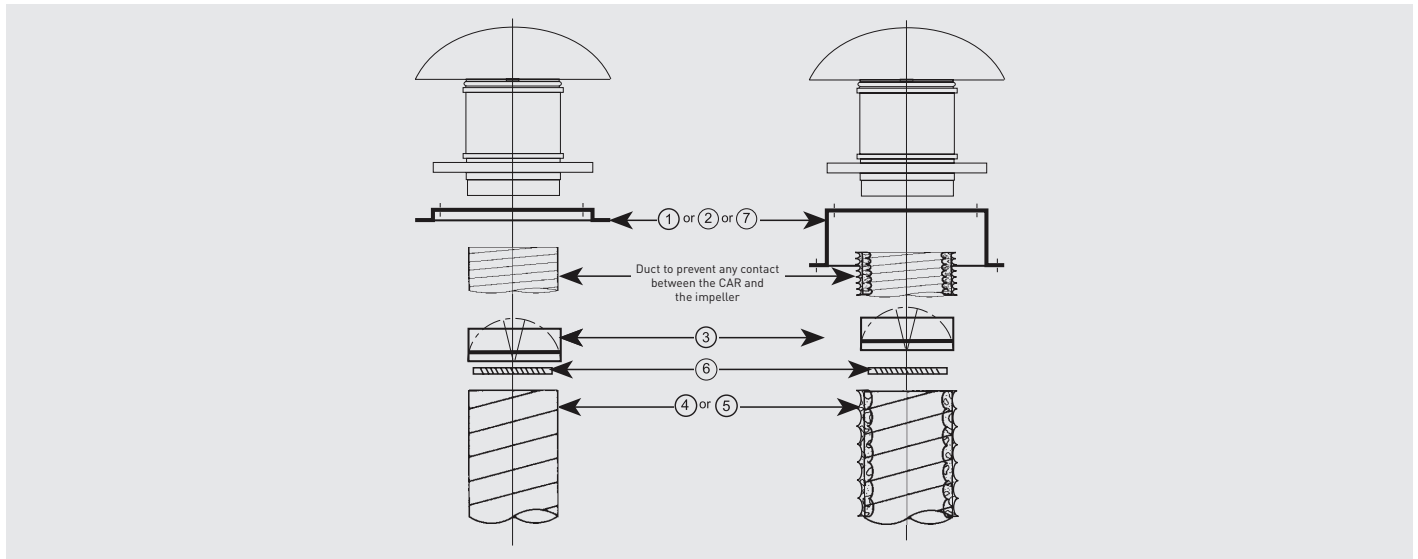

Model	① Sealing frame	② Flat roof upstand	③ Backdraft shutter	④ Flexible ducting	⑤ Flexible acoustic ducting	⑥ Worm drive clips	⑦ Support base for curb mounted installations
TH-500/150	JMS-300	JBS-300	CAR-150	GSA-150	GSI-160	CX-215	BI-3
TH-500/160	JMS-300	JBS-300	CAR-160	GSA-160	GSI-160	CX-215	BI-3
TH-800 N	JMS-300	JBS-300	CAR-200	GSA-200	GSI-200	CX-250	BI-3
TH-800	JMS-300	JBS-300	CAR-200	GSA-200	GSI-200	CX-250	BI-3
TH-1300	JMS-435	JBS-435	CAR-250	GSA-250	GSI-250	CX-315	BI-4
TH-2000	JMS-560	JBS-560	CAR-315	GSA-315	GSI-315	CX-315	BI-5

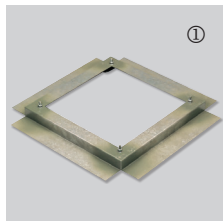

JMS Sealing frame
 - For mounting the roof fans on an up stand or base.
 - Provided with screws and gasket for a complete seal.

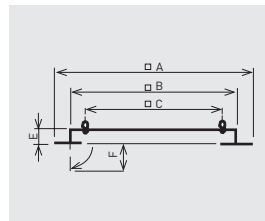

Model	A	B	C	E	F
JMS-300	470	290	245	50	70
JMS-435	600	420	330	50	70
JMS-560	725	545	450	50	70

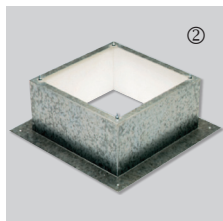

JBS Flat roof up stand
 - For mounting fans on flat roofs with no up stands.
 - Internal insulation to avoid condensation.
 - Provided with screws and gasket for a complete seal.

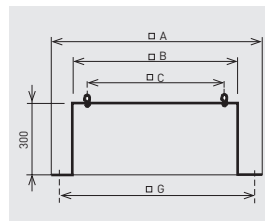

Model	A	B	C	E	G
JBS-300	470	289	245	300	380
JBS-435	600	419	330	300	510
JBS-560	725	544	450	300	635



BI Support base for inclined curb mounted installations
 - To ensure the proper installation of the BI product it is essential to specify the roof pitch angle and the distance between the roof beam profiles (as shown).

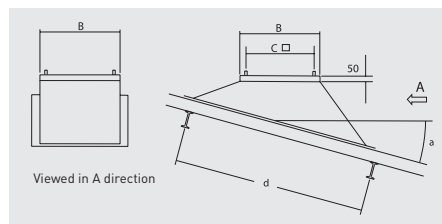

Model	B	C
BI-3	289	245
BI-4	419	330
BI-5	544	450

d: distance between the roof beam profiles
 a: roof pitch angle (curb)

MOUNTING ACCESSORIES

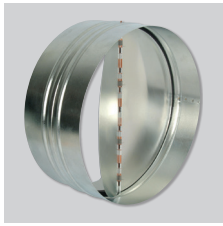

CAR
Backdraft shutter.



GSA
Flexible aluminium ducting.



CX
Worm drive clips.



SIL
Sound attenuator.

ELECTRICAL ACCESSORIES



INTER 4P and COM-3
Three speed switches.



REB
Electronic, single phase speed controller.



RMB
Auto-transformer speed controller